

A-A

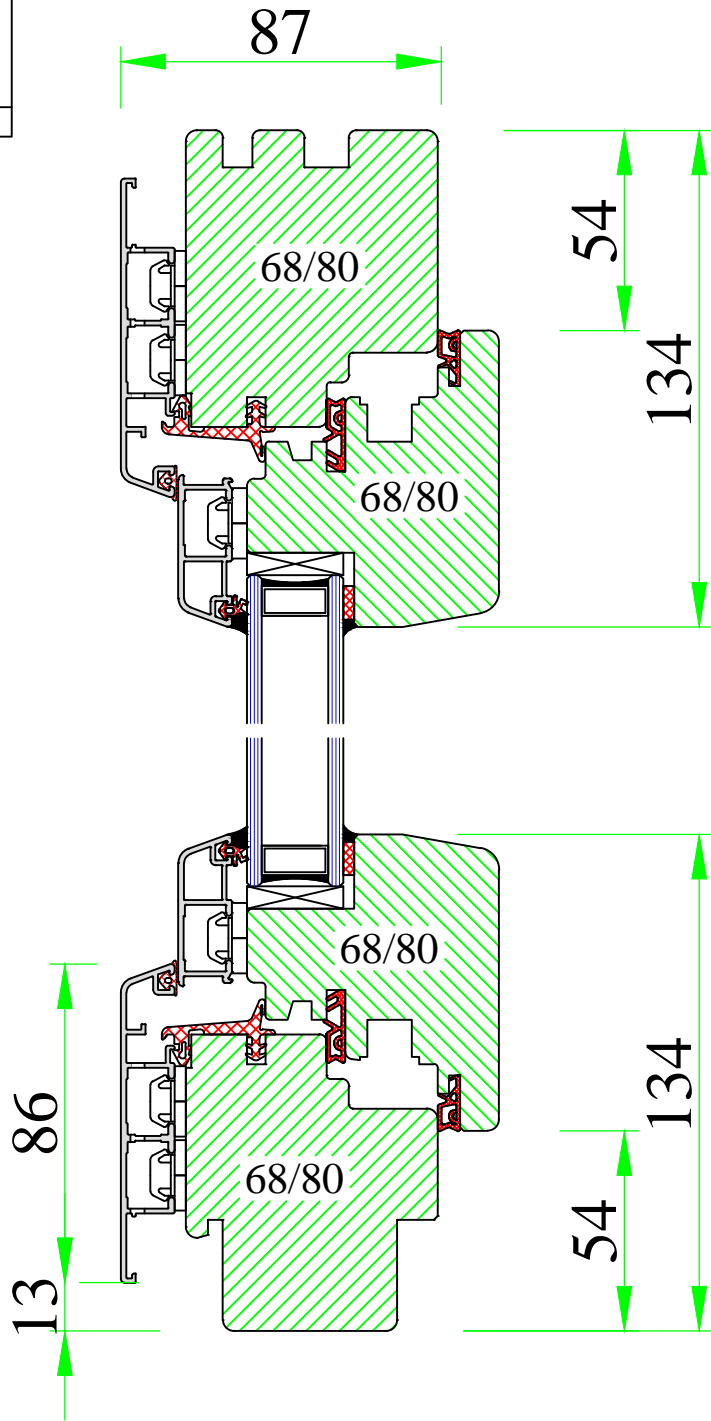

UNI WINDOWS Ltd.
 Unit 6, Edgefield Industrial Est.
 Loanhead, EH20 9TB
 Tel.: 0131 448 3931

MARCONI 1
 Inward opening tilt and turn window

Version:
1
 Date:
15.05.14

Scale:
1:2
 Drawing:
NOM/1

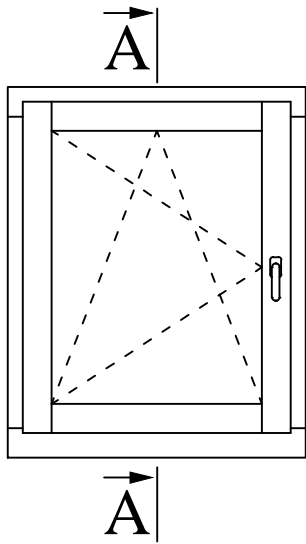

A-A

87

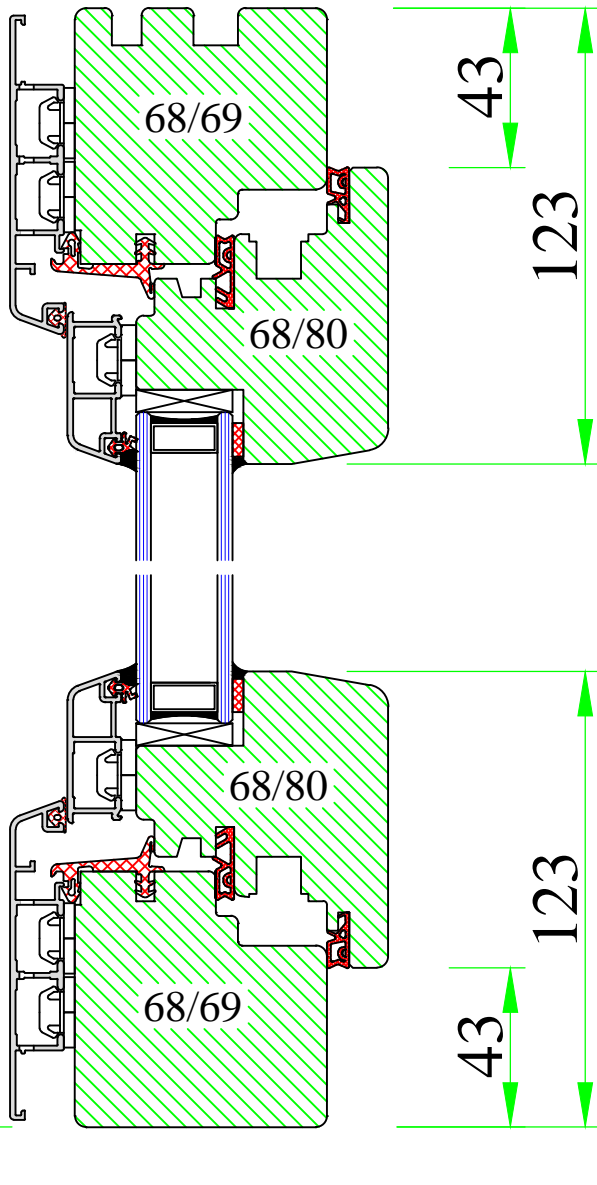

UNI WINDOWS Ltd.
 Unit 6, Edgefield Industrial Est.
 Loanhead, EH20 9TB
 Tel.: 0131 448 3931

MARCONI 2
 Inward opening tilt and turn window

Version:
1
 Date:
15.05.14

Scale:
1:2
 Drawing:
NOM2/1

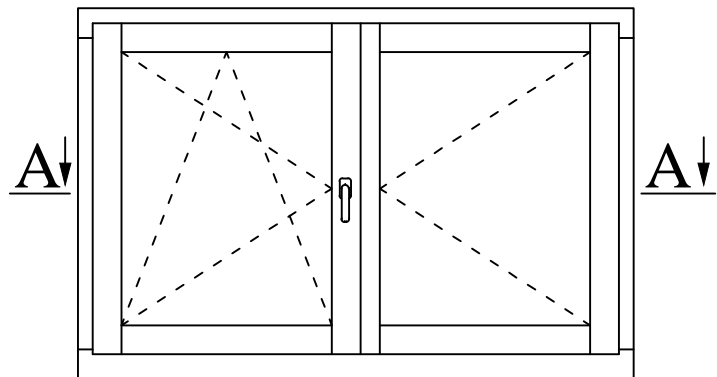

A-A

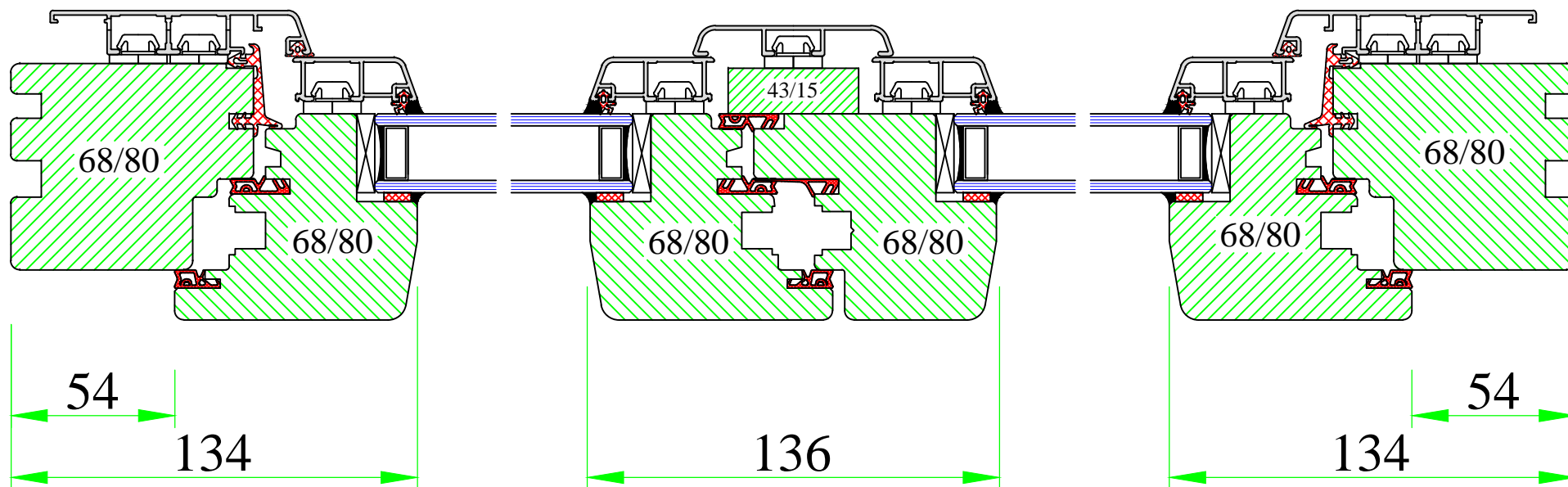

UNI WINDOWS Ltd.
 Unit 6, Edgefield Industrial Est.
 Loanhead, EH20 9TB
 Tel.: 0131 448 3931

MARCONI 1
 Double opening window with 'flying' mullion

Version: 1	Scale: 1:2
Date: 15.05.14	Drawing: NOM/2

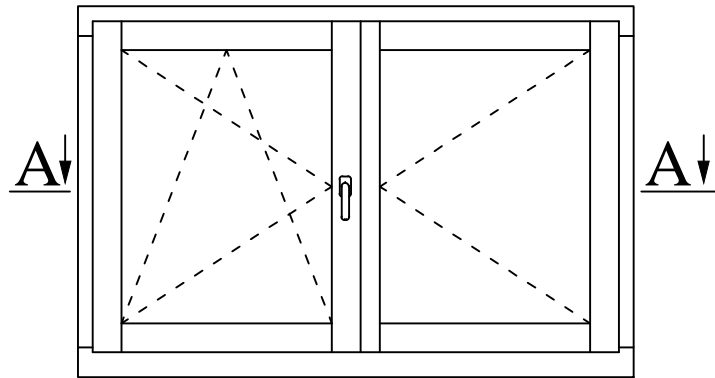

A-A

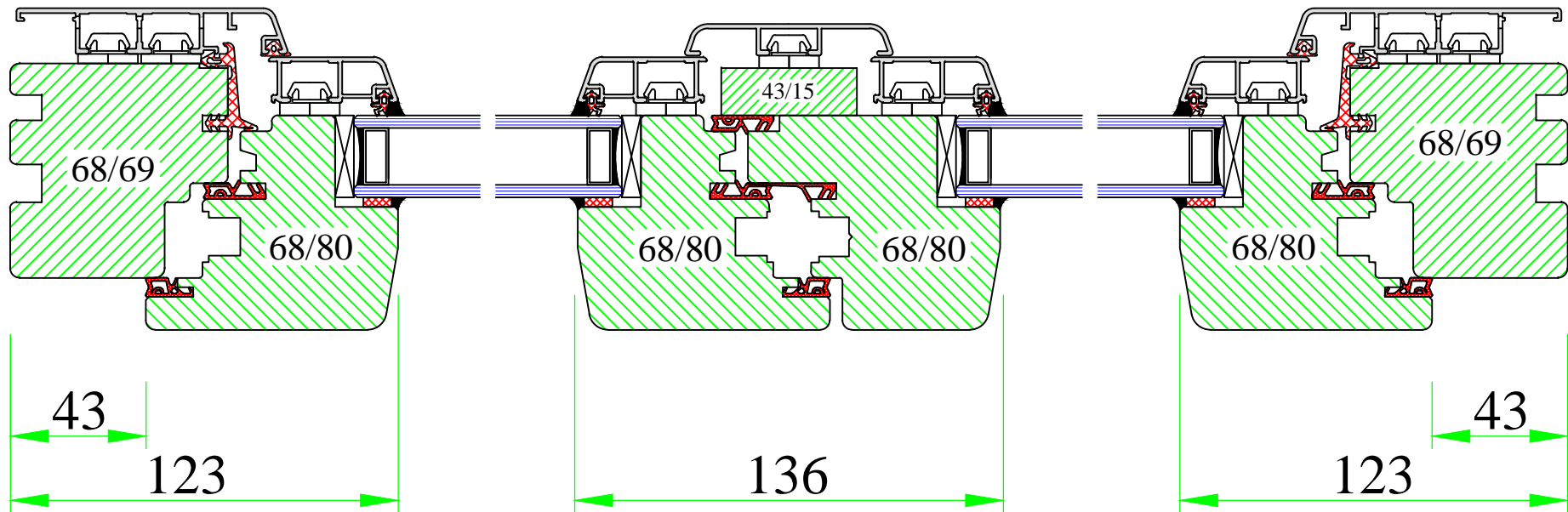

UNI WINDOWS Ltd.
 Unit 6, Edgefield Industrial Est.
 Loanhead, EH20 9TB
 Tel.: 0131 448 3931

MARCONI 2
 Double opening window with 'flying' mullion

Version:
1
 Date:
15.05.14

Scale:
1:2
 Drawing:
NOM2/2

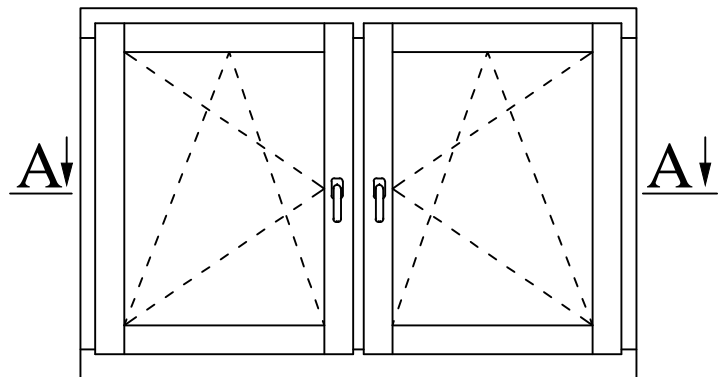

A-A

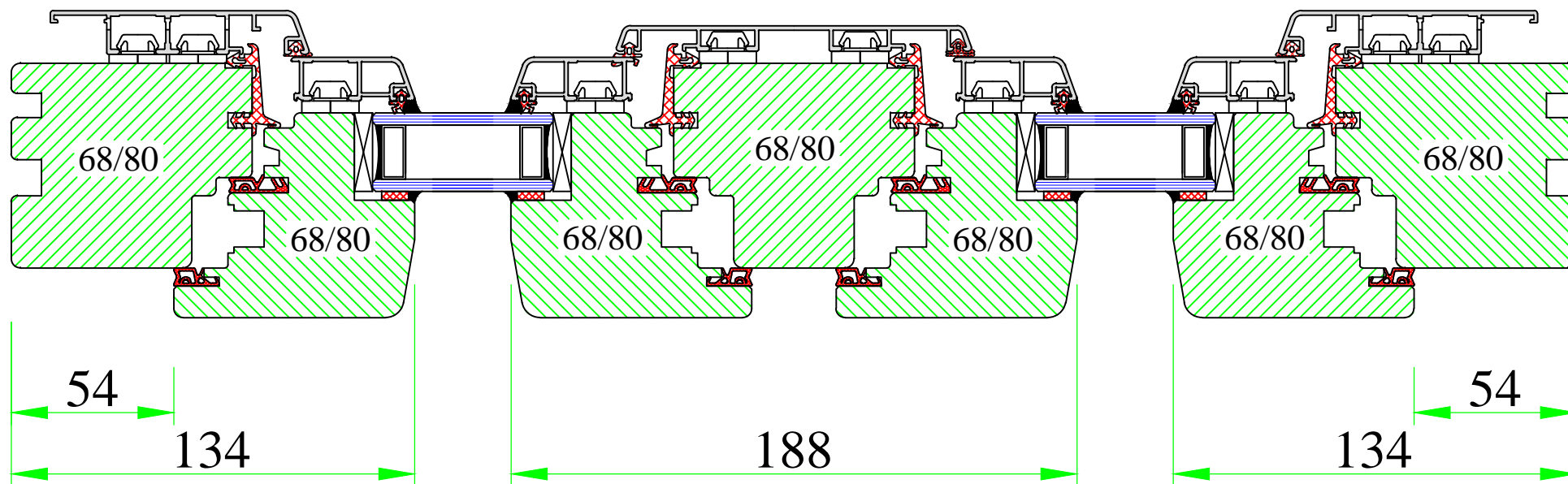

www.uniwin.co.uk



UNI WINDOWS Ltd.
 Unit 6, Edgefield Industrial Est.
 Loanhead, EH20 9TB
 Tel.: 0131 448 3931

MARCONI 1
 Double opening window fixed mullion 80mm

Version: 1	Scale: 1:3
Date: 15.05.14	Drawing: NOM/3

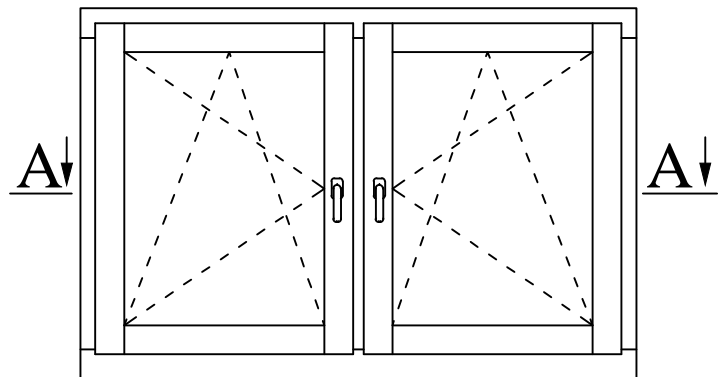

A-A

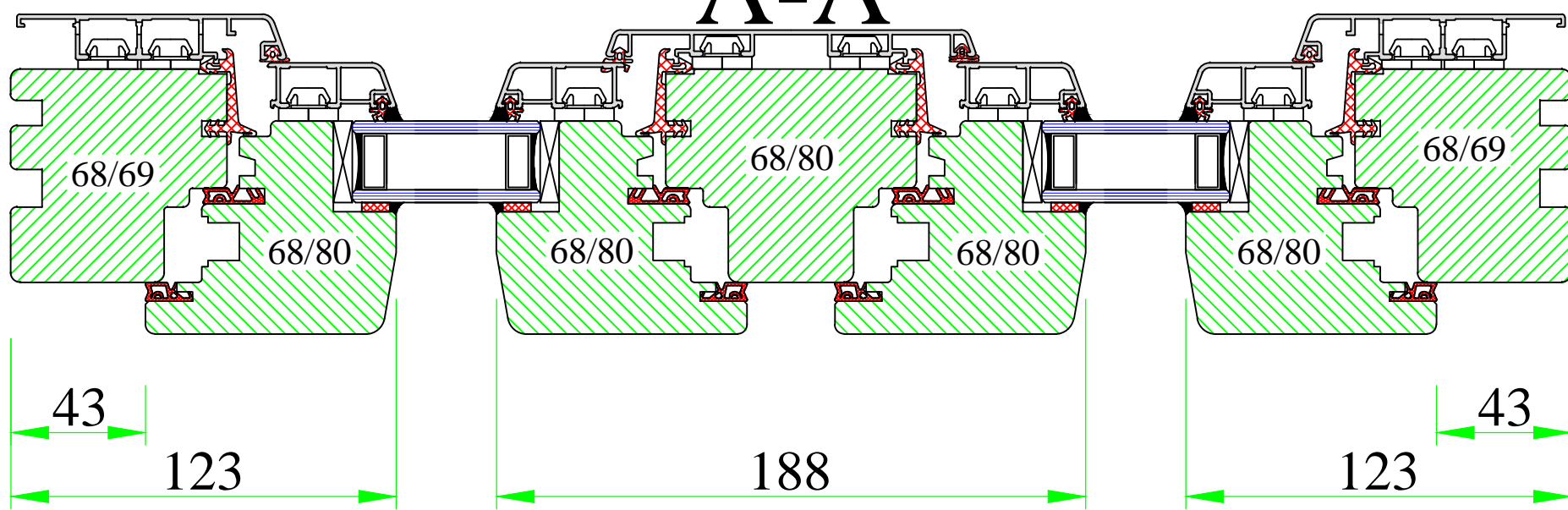

UNI WINDOWS Ltd.
 Unit 6, Edgefield Industrial Est.
 Loanhead, EH20 9TB
 Tel.: 0131 448 3931

MARCONI 2
 Double opening window fixed mullion 80mm

Version: 1	Scale: 1:2
Date: 15.05.14	Drawing: NOM2/3

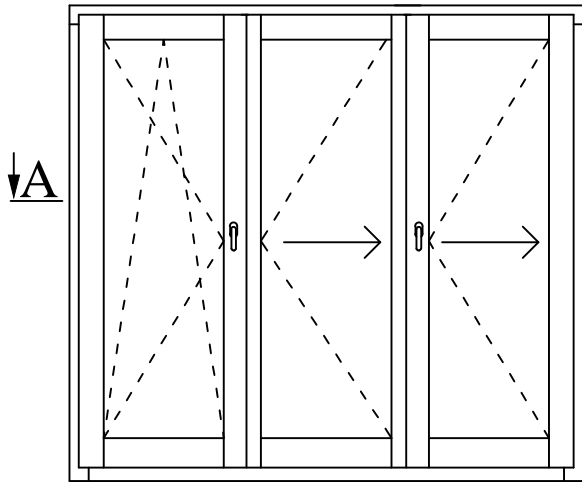

A

A-A

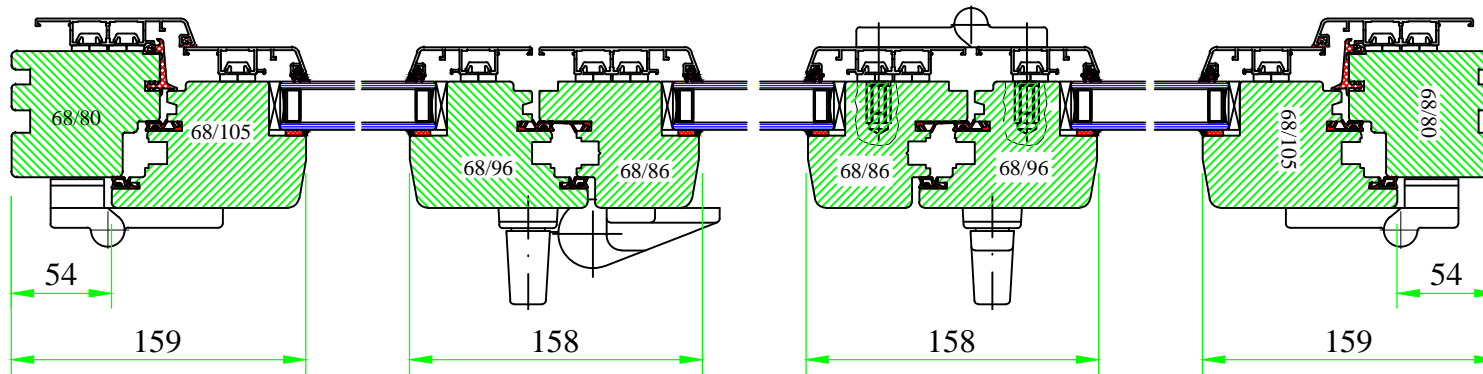

UNI WINDOWS Ltd.
 Unit 6, Edgefield Industrial Est.
 Loanhead, EH20 9TB
 Tel.: 0131 448 3931

Folding sliding doors

MARCONI 1

Version:
1

Scale:
1:4

Date:
15.05.14

Drawing:
NOM/4

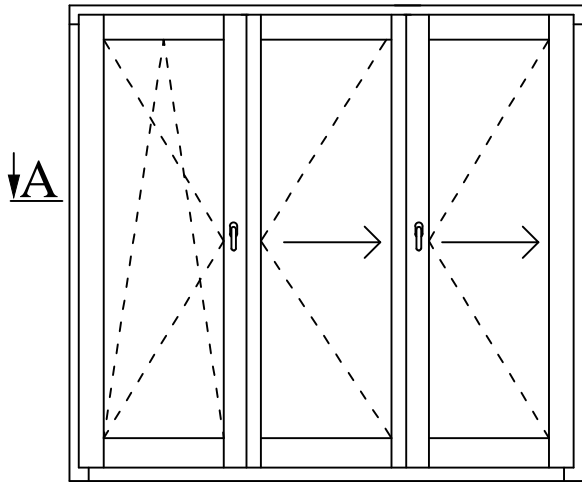

A↓

A-A

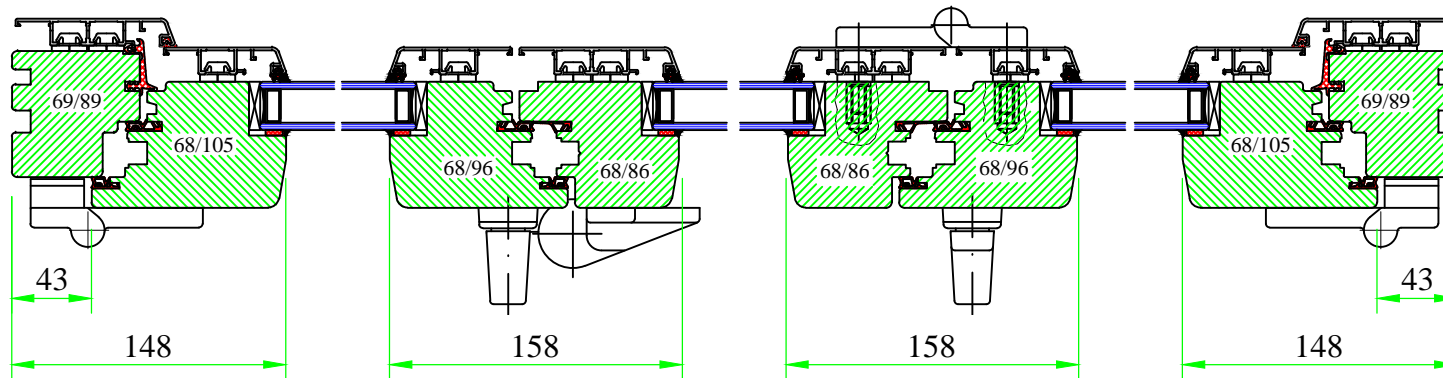

UNI WINDOWS Ltd.
 Unit 6, Edgefield Industrial Est.
 Loanhead, EH20 9TB
 Tel.: 0131 448 3931

Folding sliding doors

MARCONI 2

Version:
1

Scale:
1:2

Date:
15.05.14

Drawing:
NOM2/4

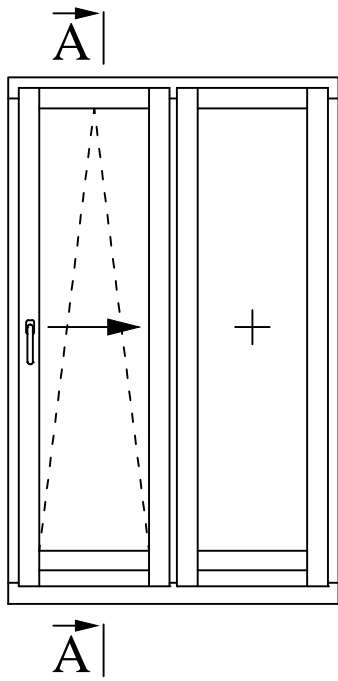

A-A

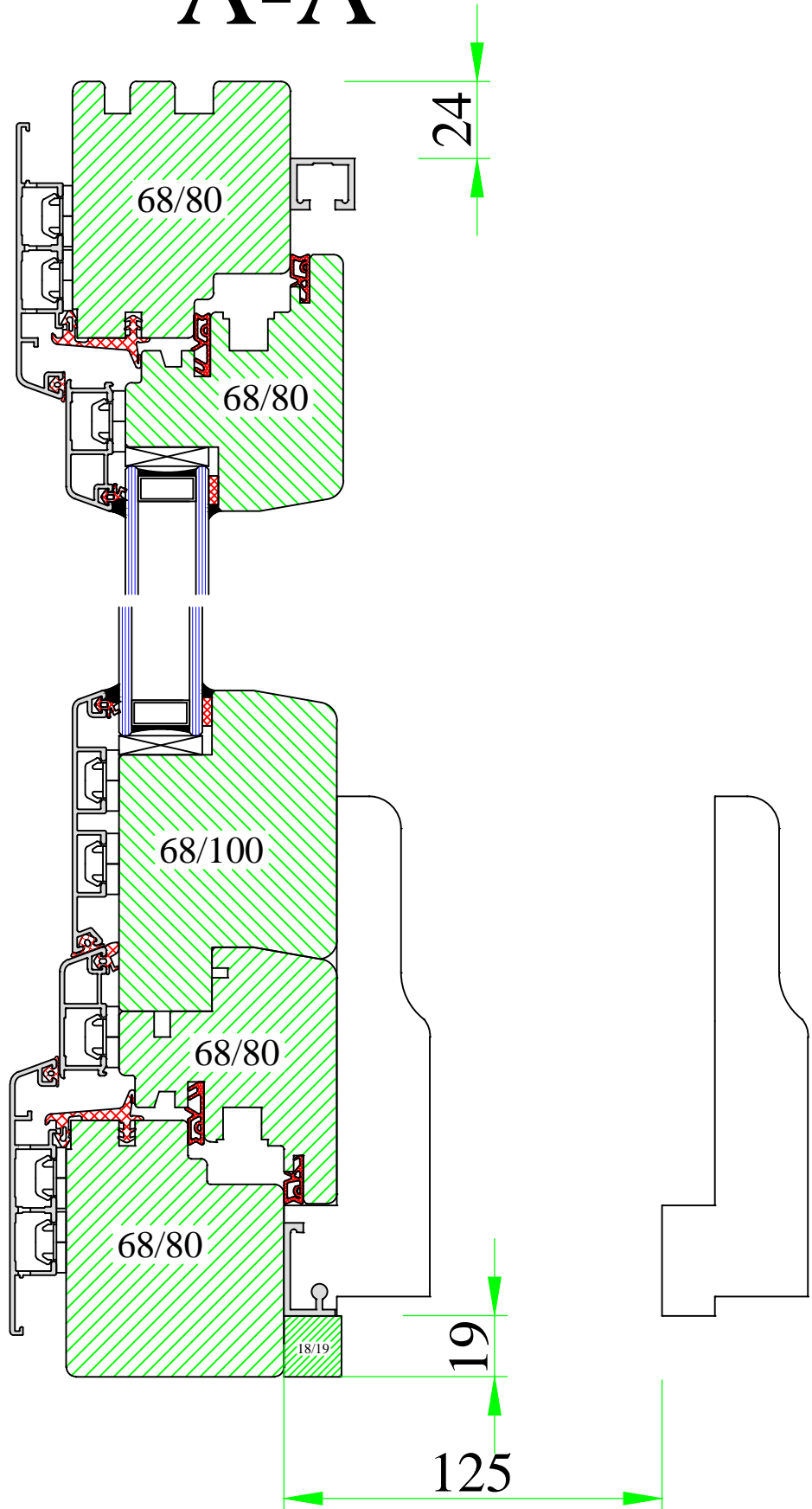

www.uniwin.co.uk



UNI WINDOWS Ltd.
 Unit 6, Edgefield Industrial Est.
 Loanhead, EH20 9TB
 Tel.: 0131 448 3931

Tilt and slide doors

MARCONI

Version:
1

Scale:
1:2

Date:
15.05.14

Drawing:
NOM/8

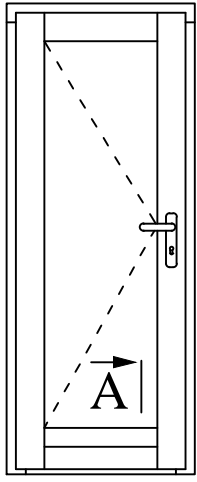

A

out

13

68/92

68/80

in

196

Y

24

0



UNI WINDOWS Ltd.
 Unit 6, Edgefield Industrial Est.
 Loanhead, EH20 9TB
 Tel.: 0131 448 3931

MARCONI 1 / 2
 External door with flat Weser threshold

Version:
1
 Date:
15.05.14

Scale:
1:1
 Drawing:
NMD/1

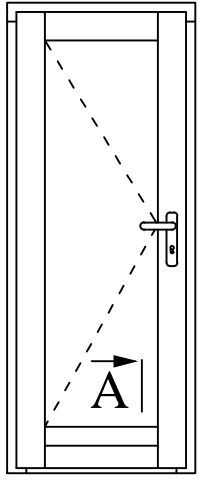

A

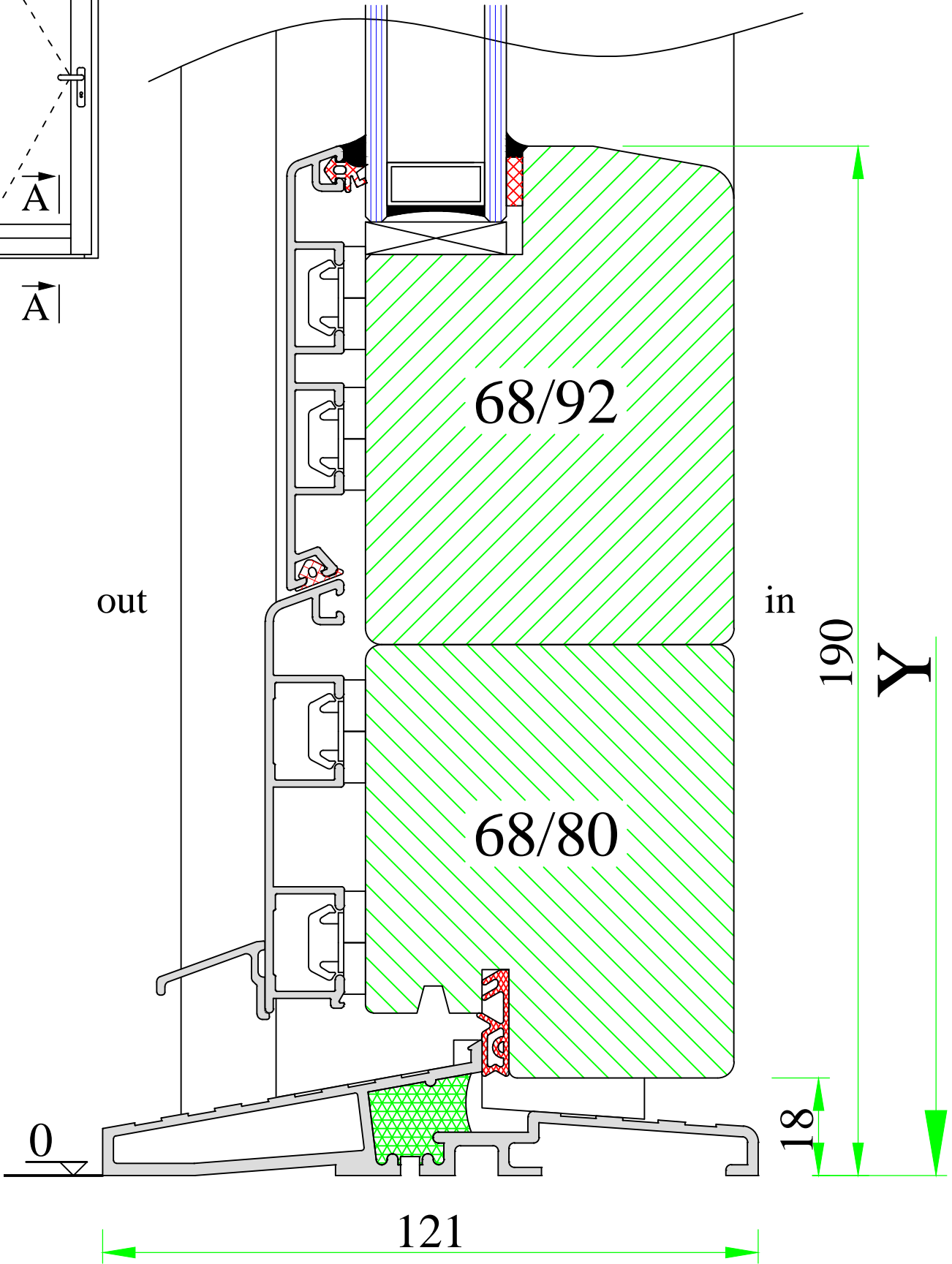

www.uniwin.co.uk



UNI WINDOWS Ltd.
 Unit 6, Edgefield Industrial Est.
 Loanhead, EH20 9TB
 Tel.: 0131 448 3931

MARCONI 1 / 2
 External door with flat threshold DAFA

Version:
1
 Date:
15.05.14

Scale:
1:1
 Drawing:
NMD/2

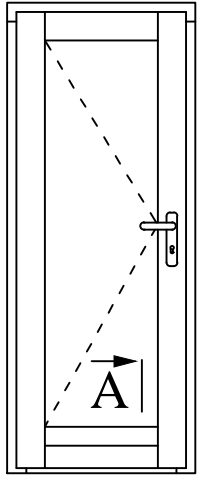

A

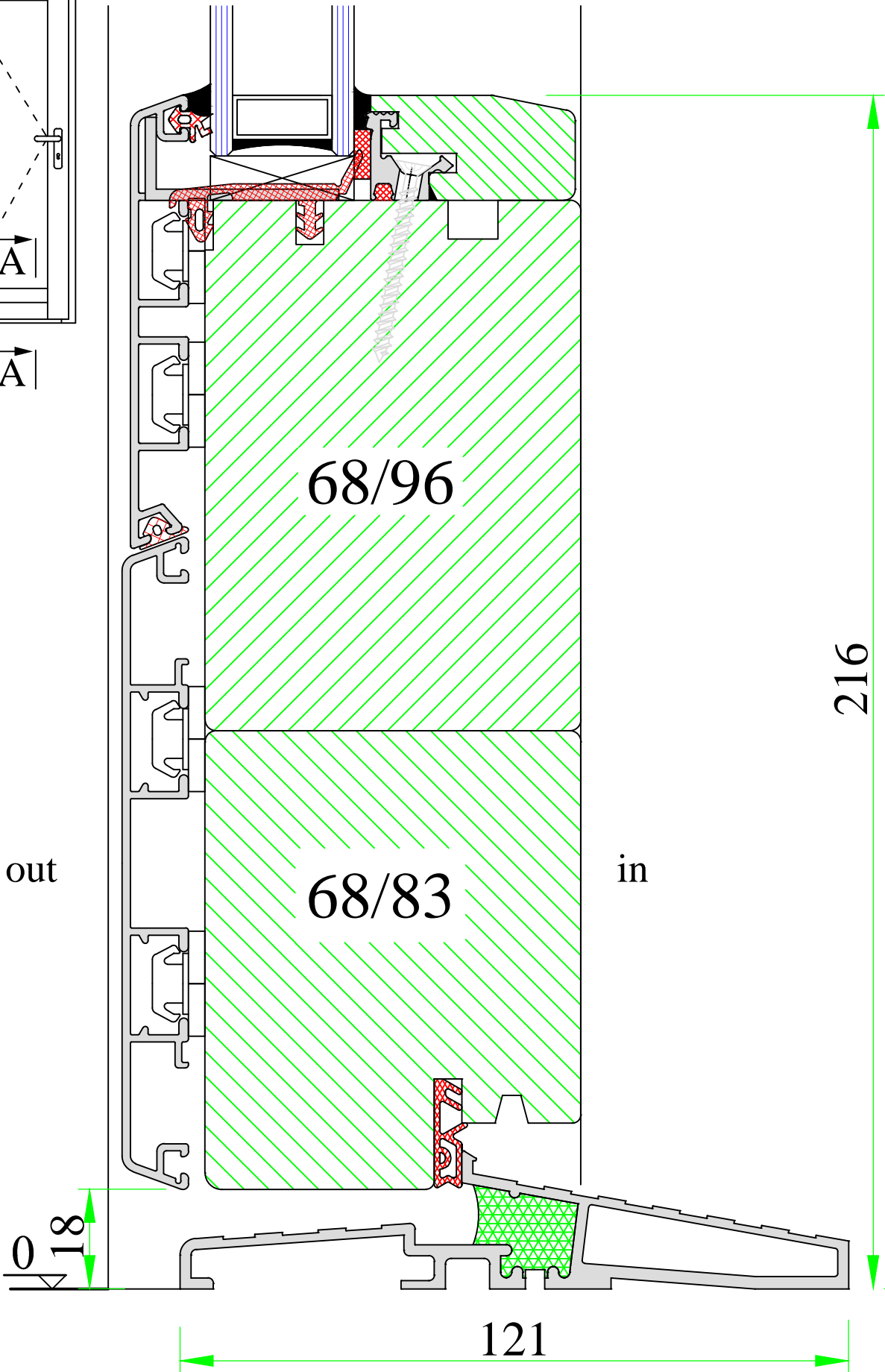

Y

0 18

121

216

www.uniwin.co.uk



UNI WINDOWS Ltd.
 Unit 6, Edgefield Industrial Est.
 Loanhead, EH20 9TB
 Tel.: 0131 448 3931

MARCONI

External door with threshold DAFA –
 – outward opening

Version:
 1
 Date:
 15.05.14

Scale:
 1:1
 Drawing:
 NMD/3

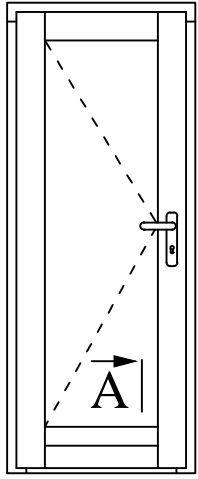

A

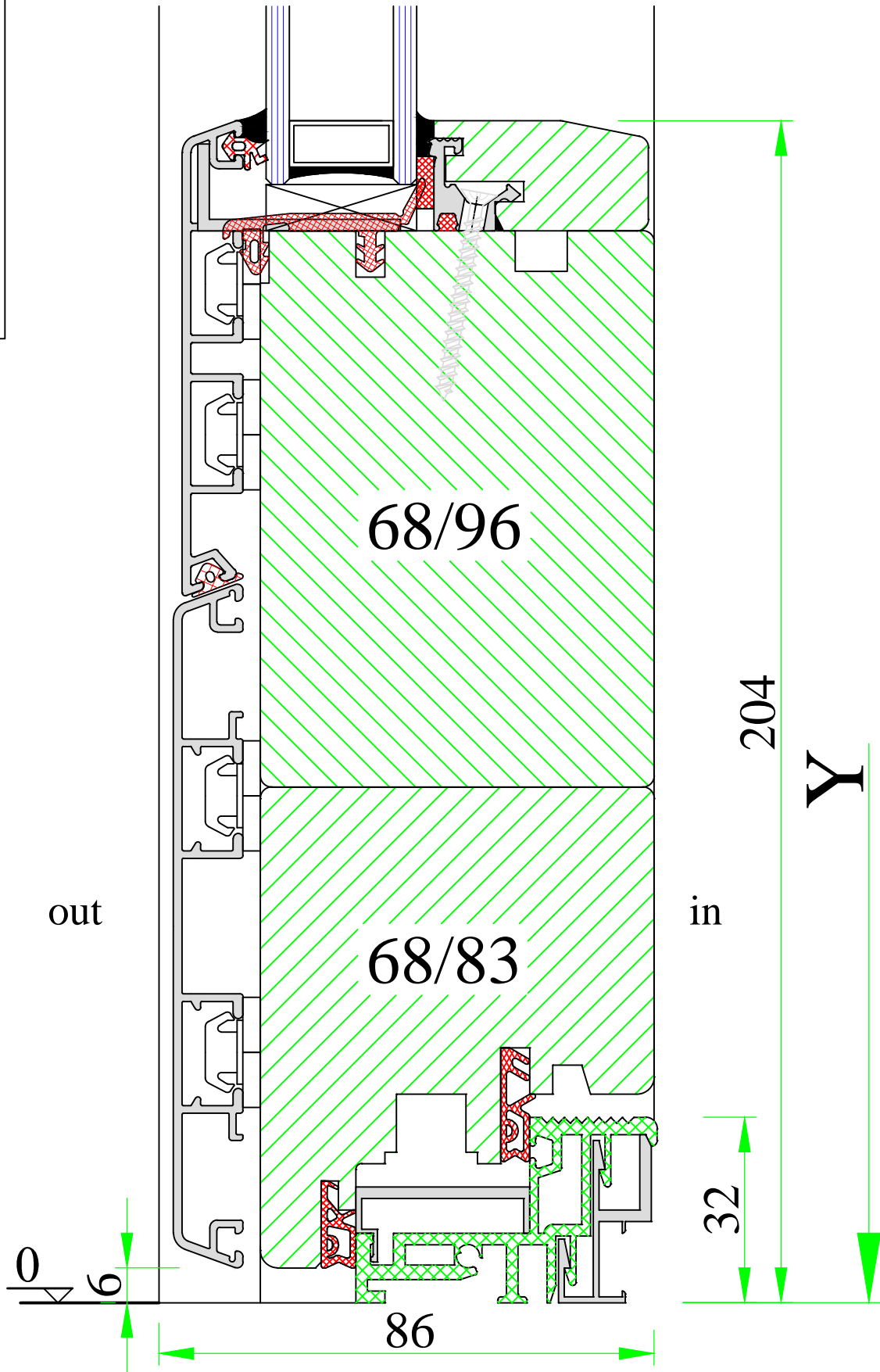

www.uniwin.co.uk



UNI WINDOWS Ltd.
 Unit 6, Edgefield Industrial Est.
 Loanhead, EH20 9TB
 Tel.: 0131 448 3931

MARCONI 1 / 2

External door with Weser-A threshold -
 - outward opening

Version:
1

Scale:
1:1

Date:
15.05.14

Drawing:
NMD/3-1

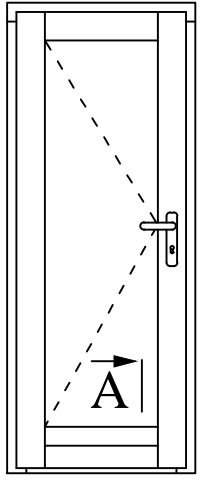

A

out

68/92

in

68/80

185

Y

0

13

85

www.uniwin.co.uk



UNI WINDOWS Ltd.
 Unit 6, Edgefield Industrial Est.
 Loanhead, EH20 9TB
 Tel.: 0131 448 3931

MARCONI 1 / 2
 External door with Weser threshold (old)

Version:
1
 Date:
15.05.14

Scale:
1:1
 Drawing:
NMD/4

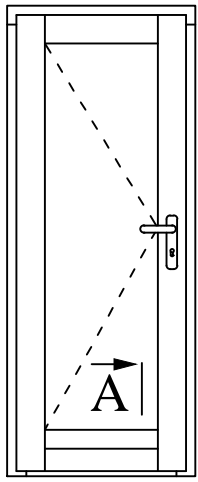

A

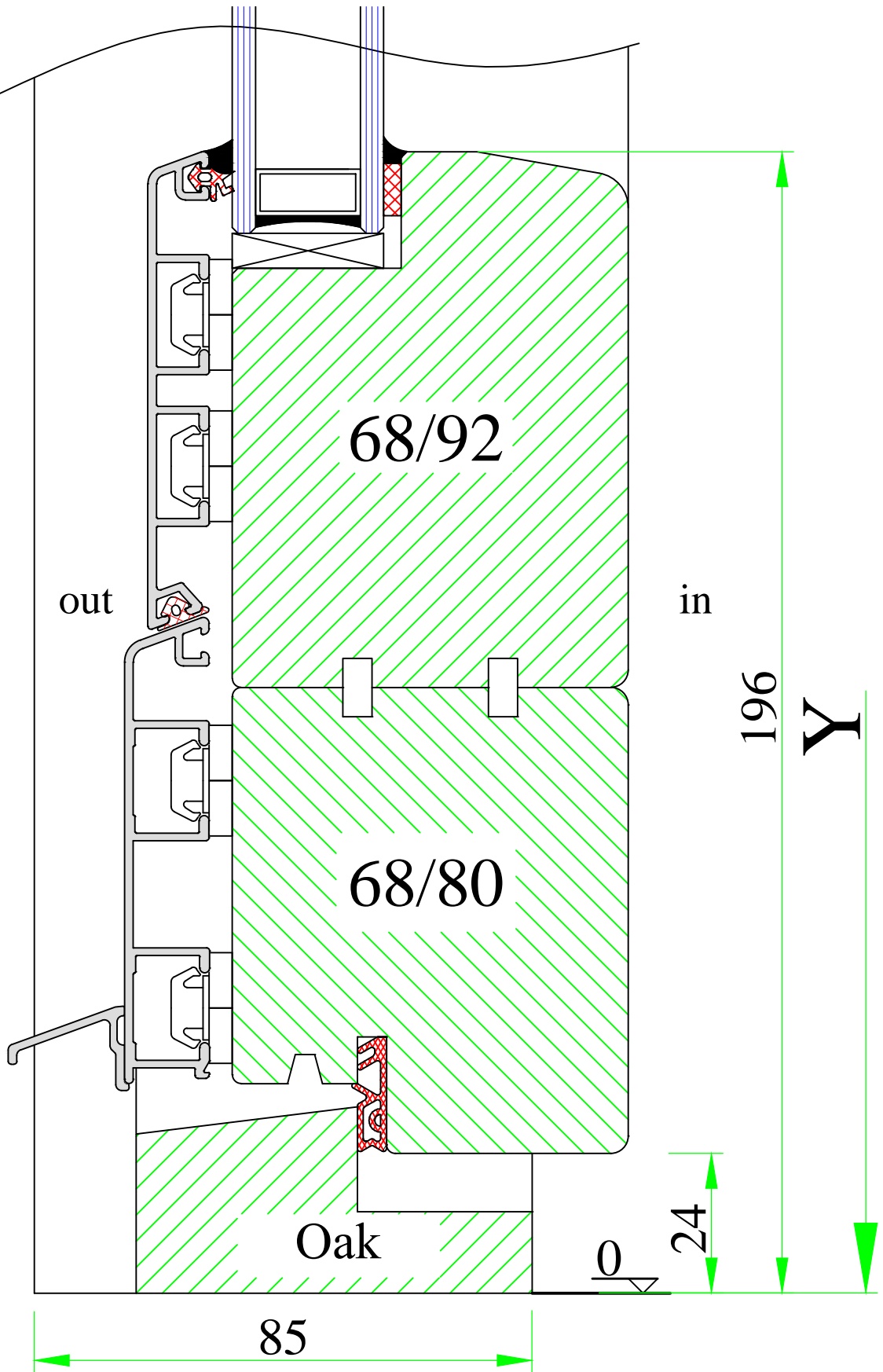

www.uniwin.co.uk



UNI WINDOWS Ltd.
 Unit 6, Edgefield Industrial Est.
 Loanhead, EH20 9TB
 Tel.: 0131 448 3931

MARCONI 1 / 2
 Timber threshold for external door – inward opening

Version:
1
 Date:
15.05.14

Scale:
1:1
 Drawing:
NMD/5

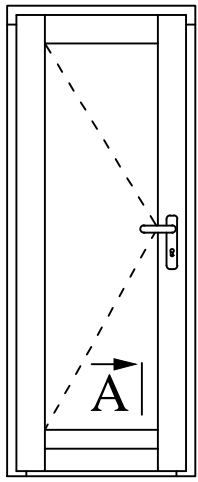

A

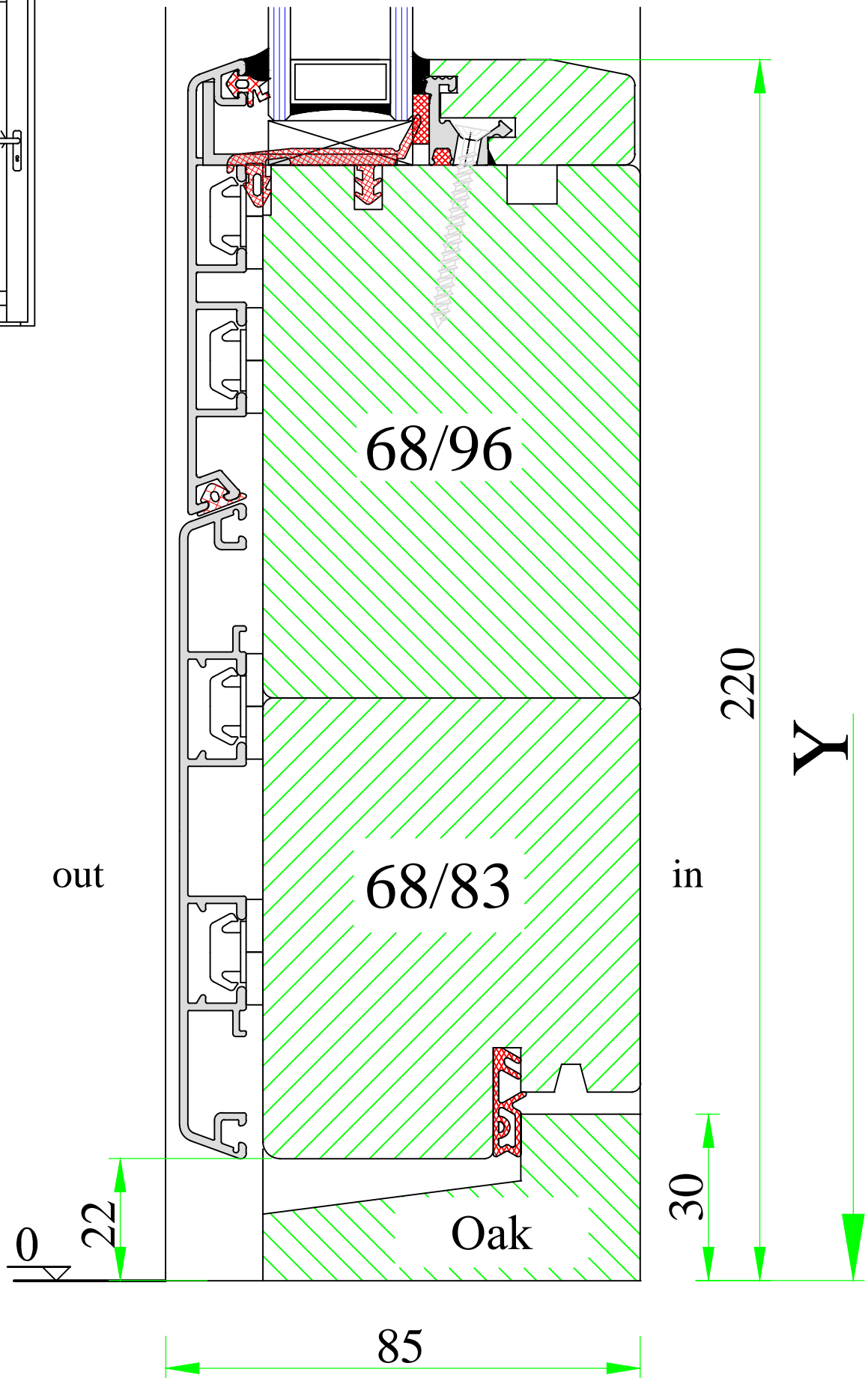

out

68/96

68/83

Oak

220
Y
in
30

85

www.uniwin.co.uk



UNI WINDOWS Ltd.
Unit 6, Edgefield Industrial Est.
Loanhead, EH20 9TB
Tel.: 0131 448 3931

MARCONI 1 / 2

Timber threshold for external door -
- outward opening

Version:
1

Scale:
1:1

Date:
15.05.14

Drawing:
NMD/6

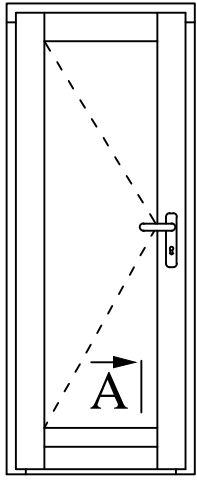

A

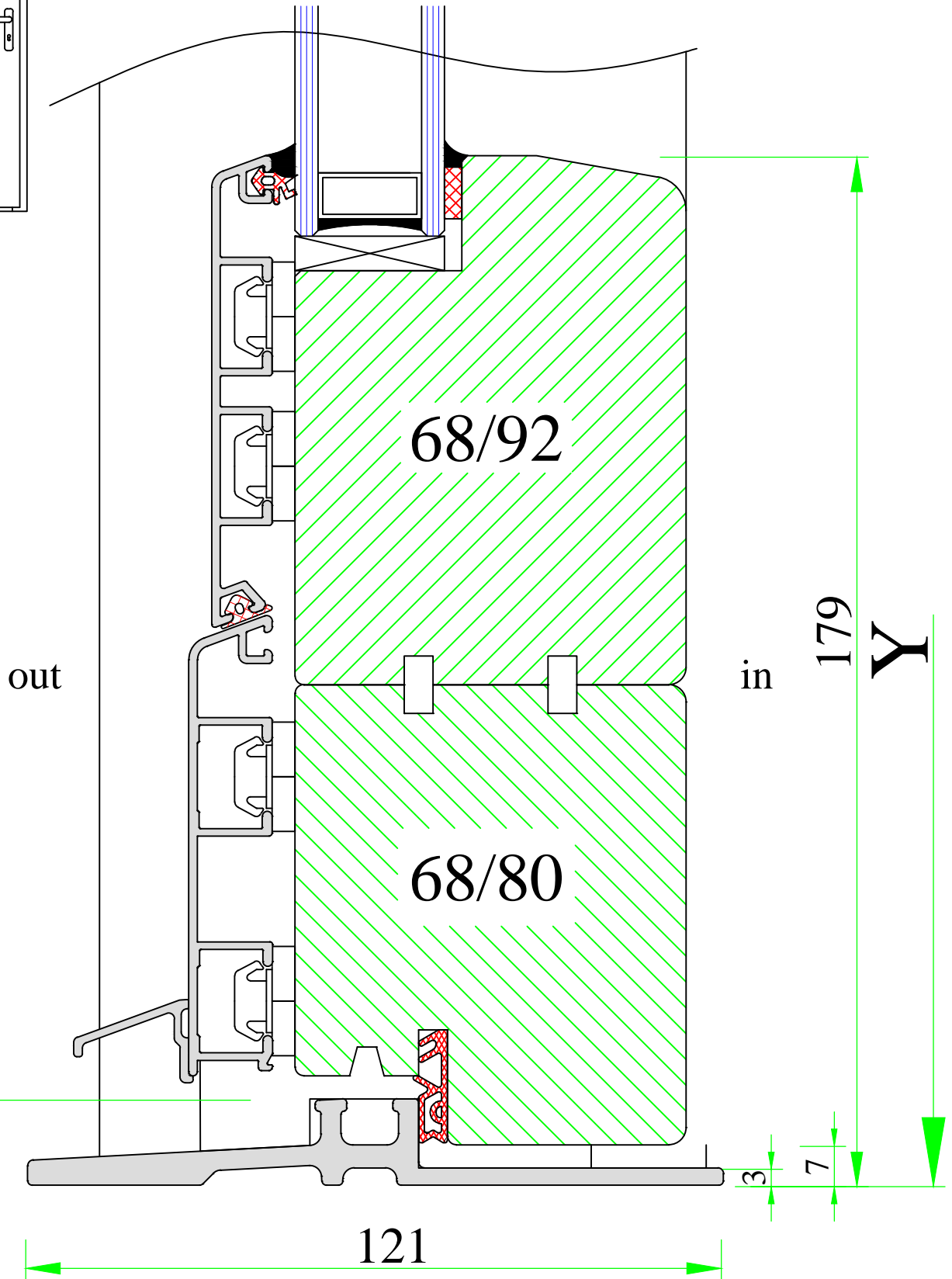

www.uniwin.co.uk



UNI WINDOWS Ltd.
 Unit 6, Edgefield Industrial Est.
 Loanhead, EH20 9TB
 Tel.: 0131 448 3931

MARCONI 1 / 2
 ULT threshold for external door

Version: 1	Scale: 1:1
Date: 15.05.14	Drawing: NMD/7

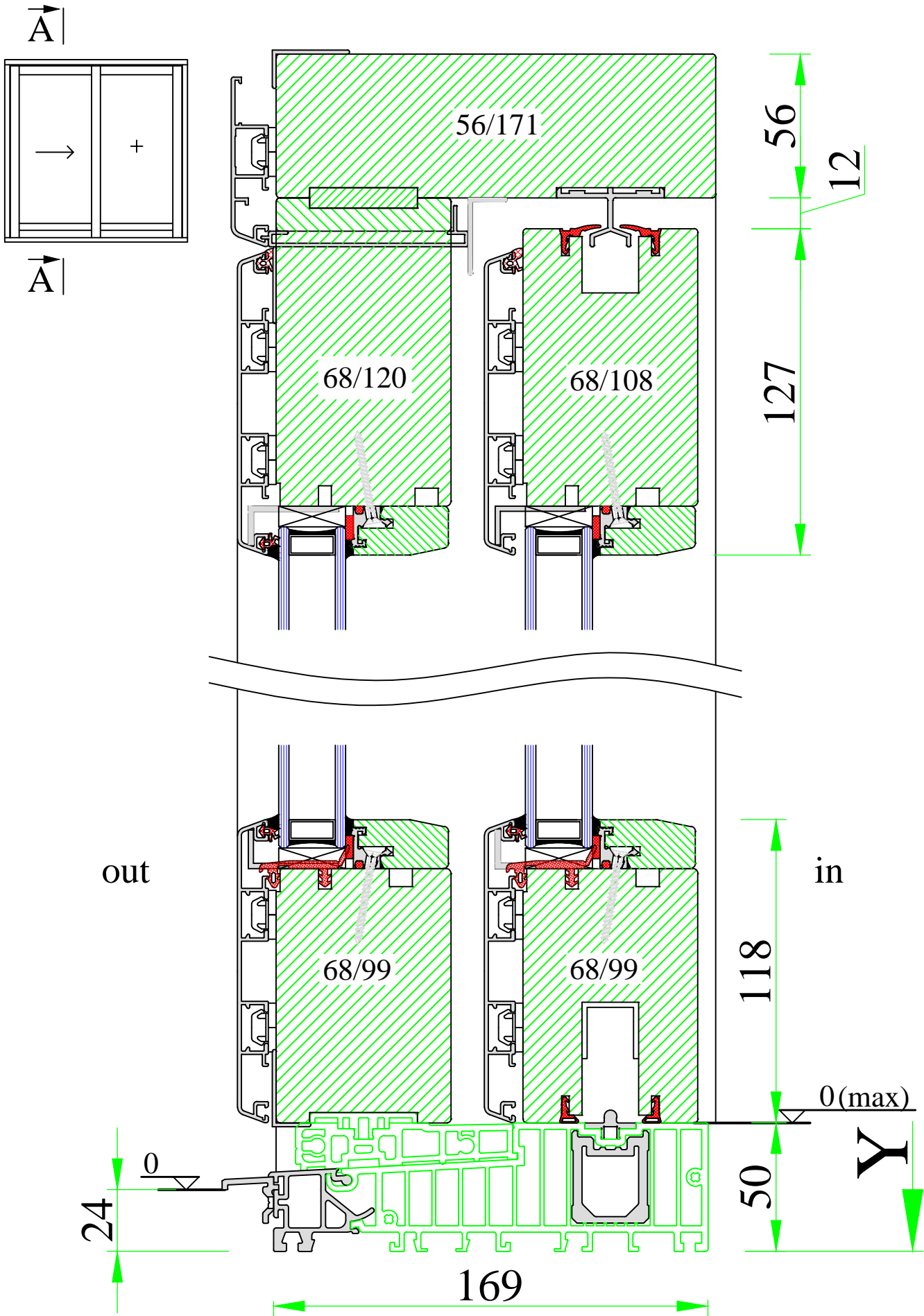

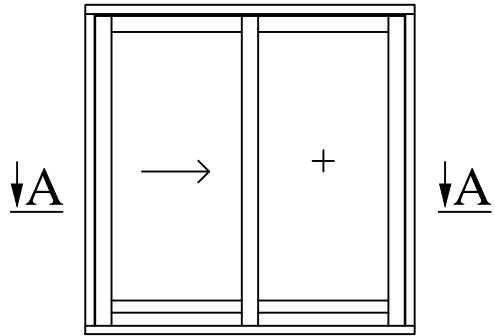

A-A

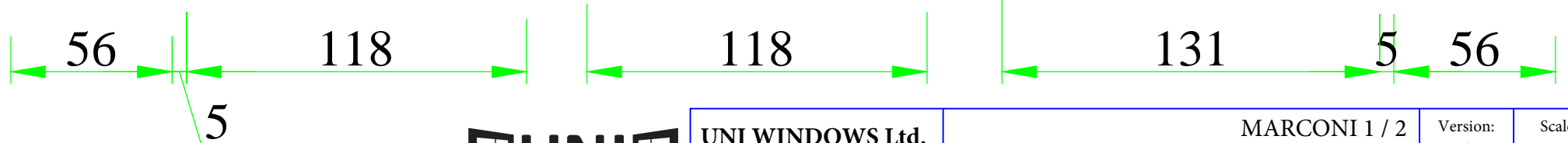
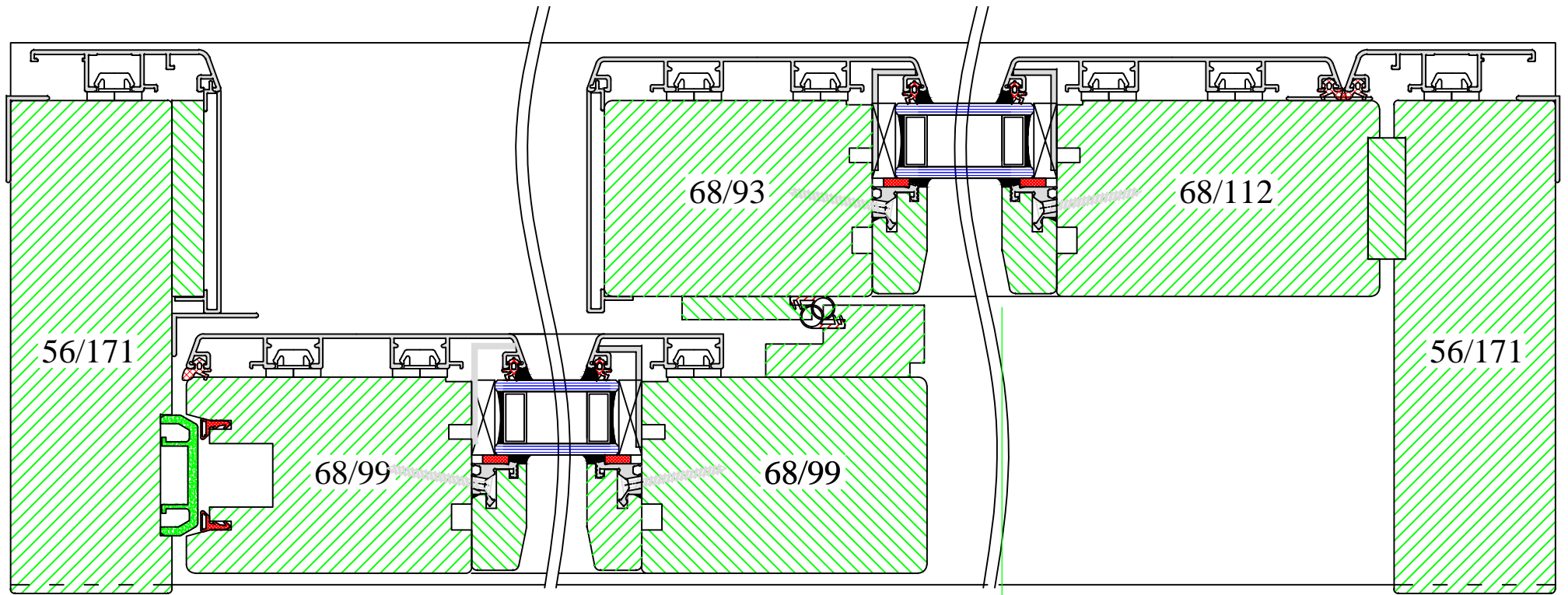

www.uniwin.co.uk



UNI WINDOWS Ltd.
 Unit 6, Edgefield Industrial Est.
 Loanhead, EH20 9TB
 Tel.: 0131 448 3931

MARCONI 1 / 2
 Lift and slide patio door – horizontal cut

Version: 1	Scale: 1:2
Date: 15.05.14	Drawing: NMHS/2

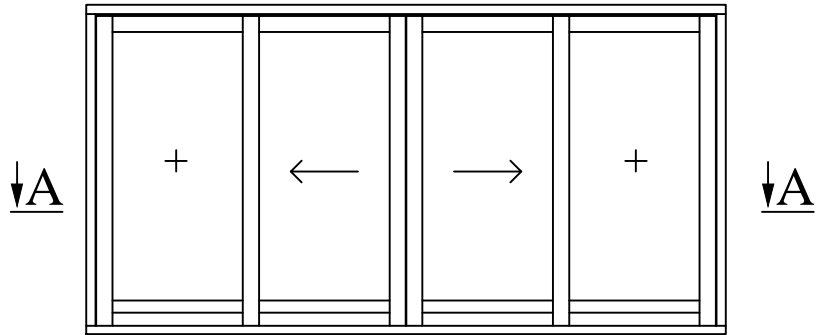

A-A

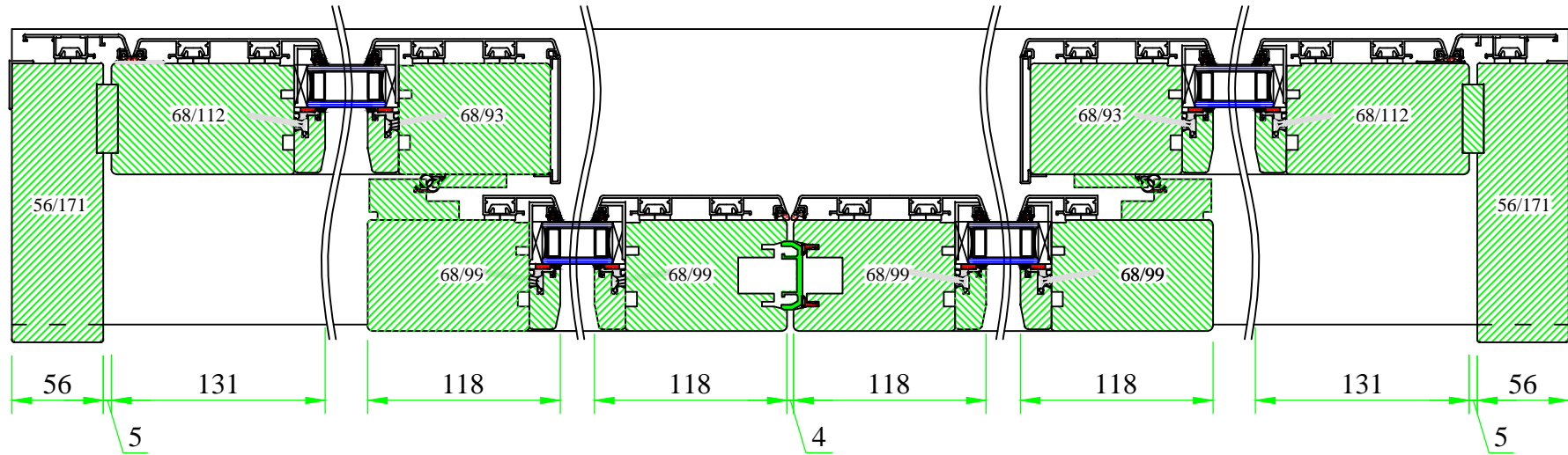

UNI WINDOWS Ltd.
 Unit 6, Edgefield Industrial Est.
 Loanhead, EH20 9TB
 Tel.: 0131 448 3931

MARCONI 1 / 2
 Lift and slide patio door – horizontal cut –
 – type C

Version: 1	Scale: 1:4
Date: 15.05.14	Drawing: NMHS/4

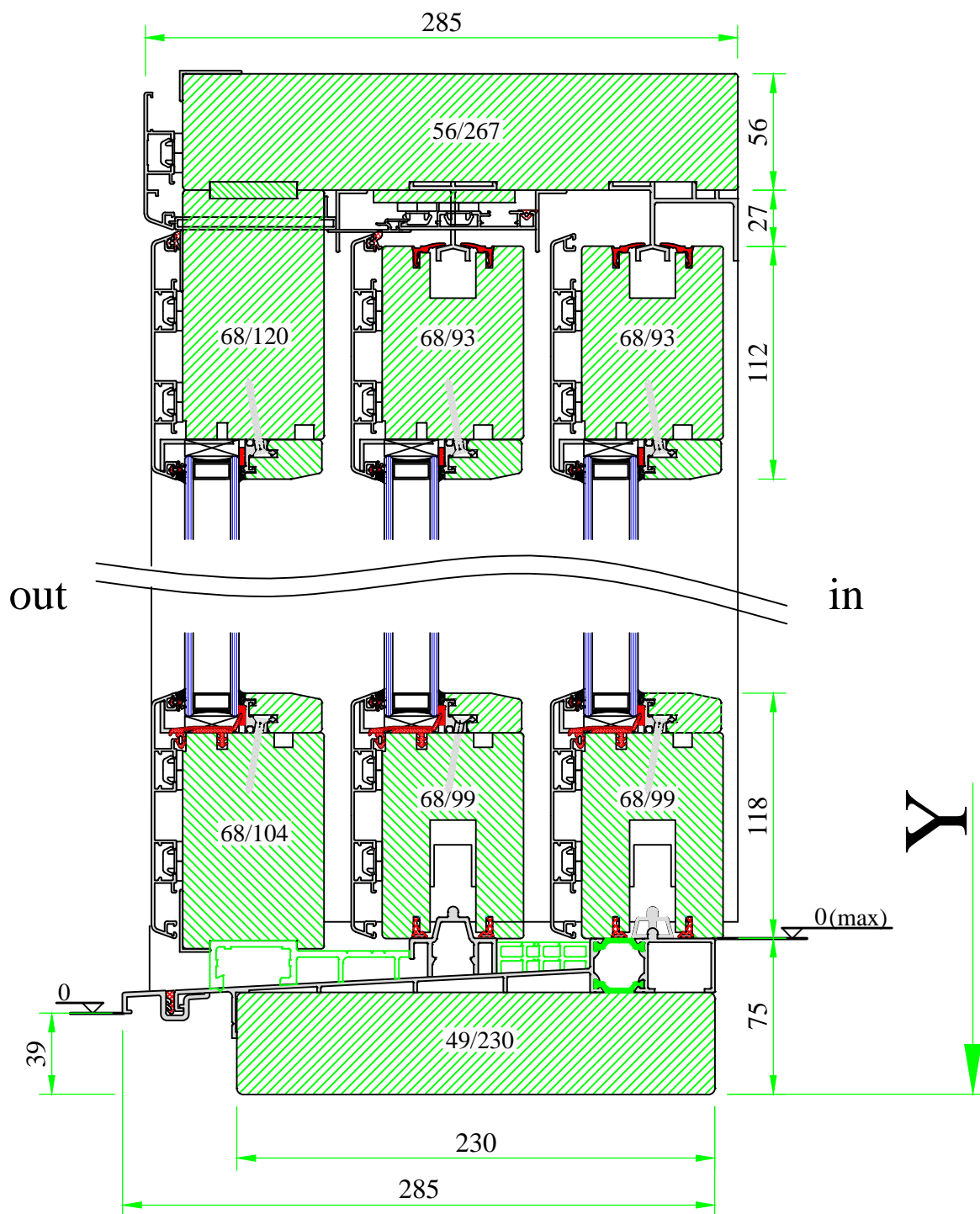
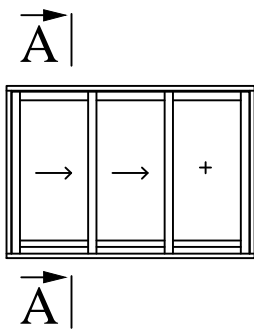

UNI WINDOWS Ltd.
 Unit 6, Edgefield Industrial Est.
 Loanhead, EH20 9TB
 Tel.: 0131 448 3931

MARCONI 1 / 2
 Lift and slide patio door – vertical cut –
 – type E

Version: 1	Scale: 1:3
Date: 15.05.14	Drawing: NMHS/5

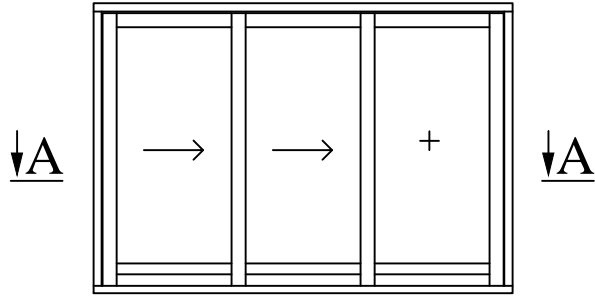

A-A

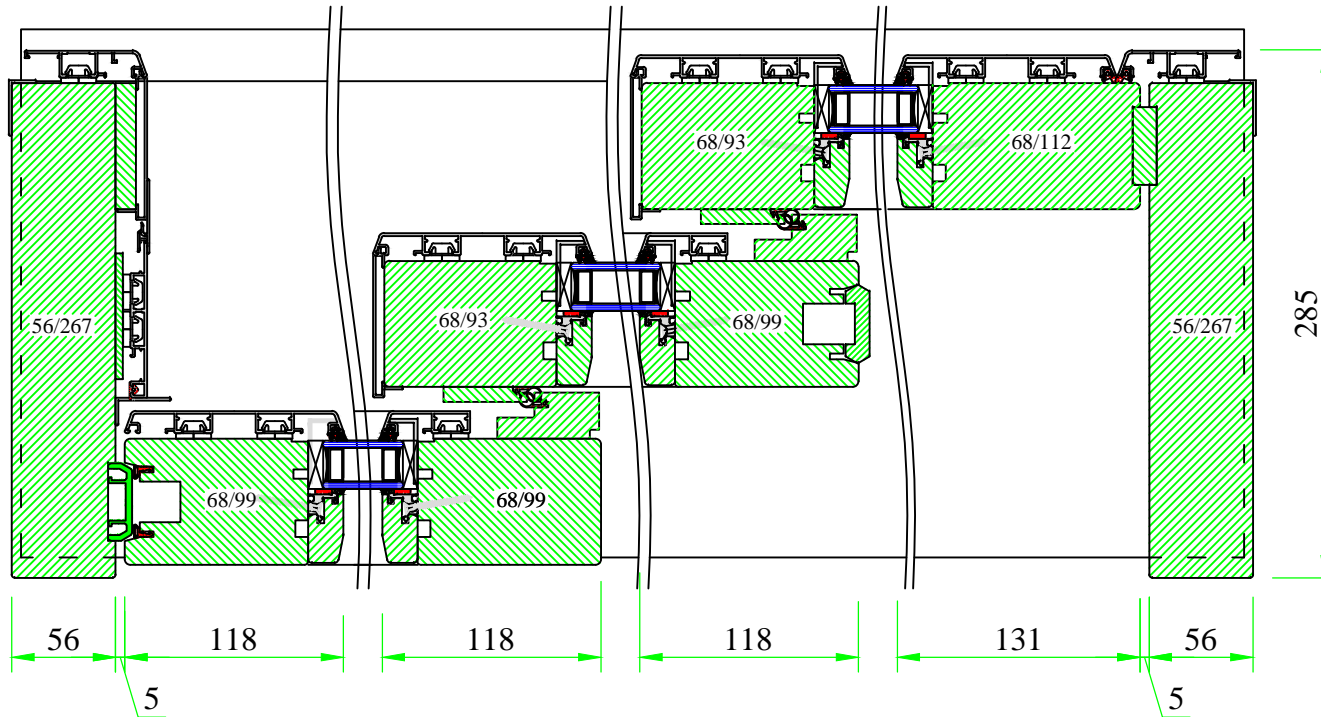

UNI WINDOWS Ltd.
 Unit 6, Edgefield Industrial Est.
 Loanhead, EH20 9TB
 Tel.: 0131 448 3931

MARCONI 1 / 2
 Lift and slide patio door – horizontal cut –
 – type E

Version: 1	Scale: 1:4
Date: 15.05.14	Drawing: NMHS/6

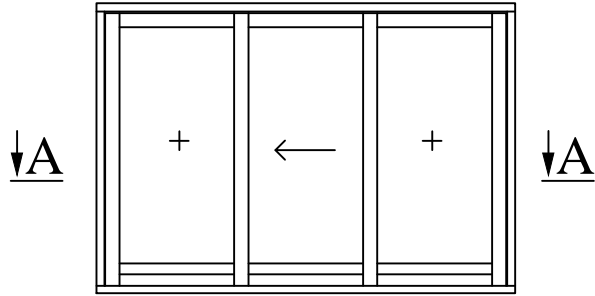

A-A

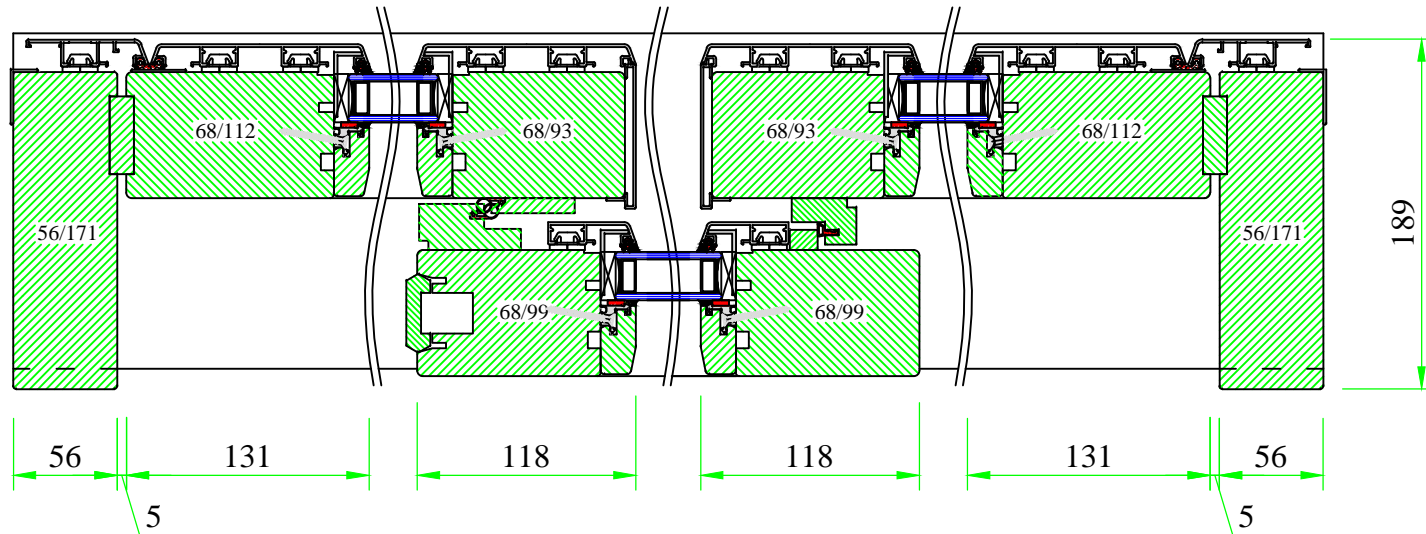

www.uniwin.co.uk



UNI WINDOWS Ltd.
 Unit 6, Edgefield Industrial Est.
 Loanhead, EH20 9TB
 Tel.: 0131 448 3931

MARCONI 1 / 2
 Lift and slide patio door – horizontal cut
 – type G

Version: 1	Scale: 1:4
Date: 15.05.14	Drawing: NMHS/7

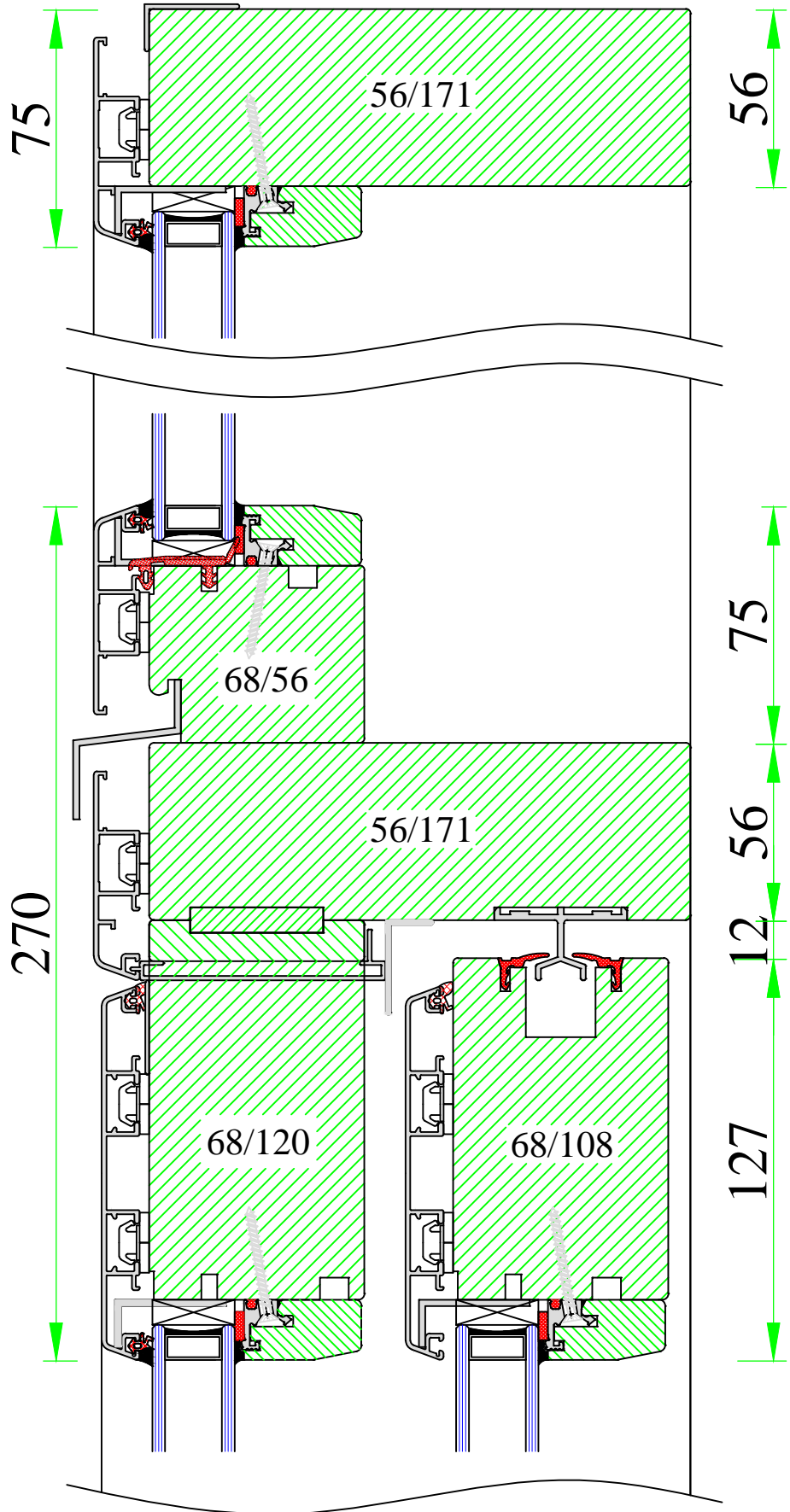
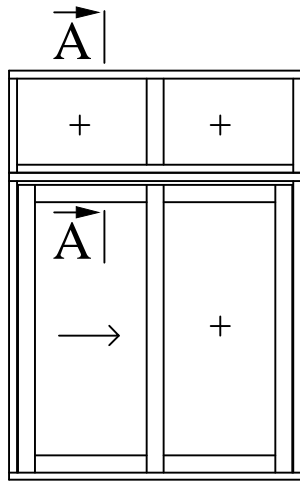

www.uniwin.co.uk



UNI WINDOWS Ltd.
 Unit 6, Edgefield Industrial Est.
 Loanhead, EH20 9TB
 Tel.: 0131 448 3931

MARCONI 1 / 2
 Lift and slide patio door with fixed top light

Version:
1
 Date:
15.05.14

Scale:
1:2
 Drawing:
NMHS/8

A

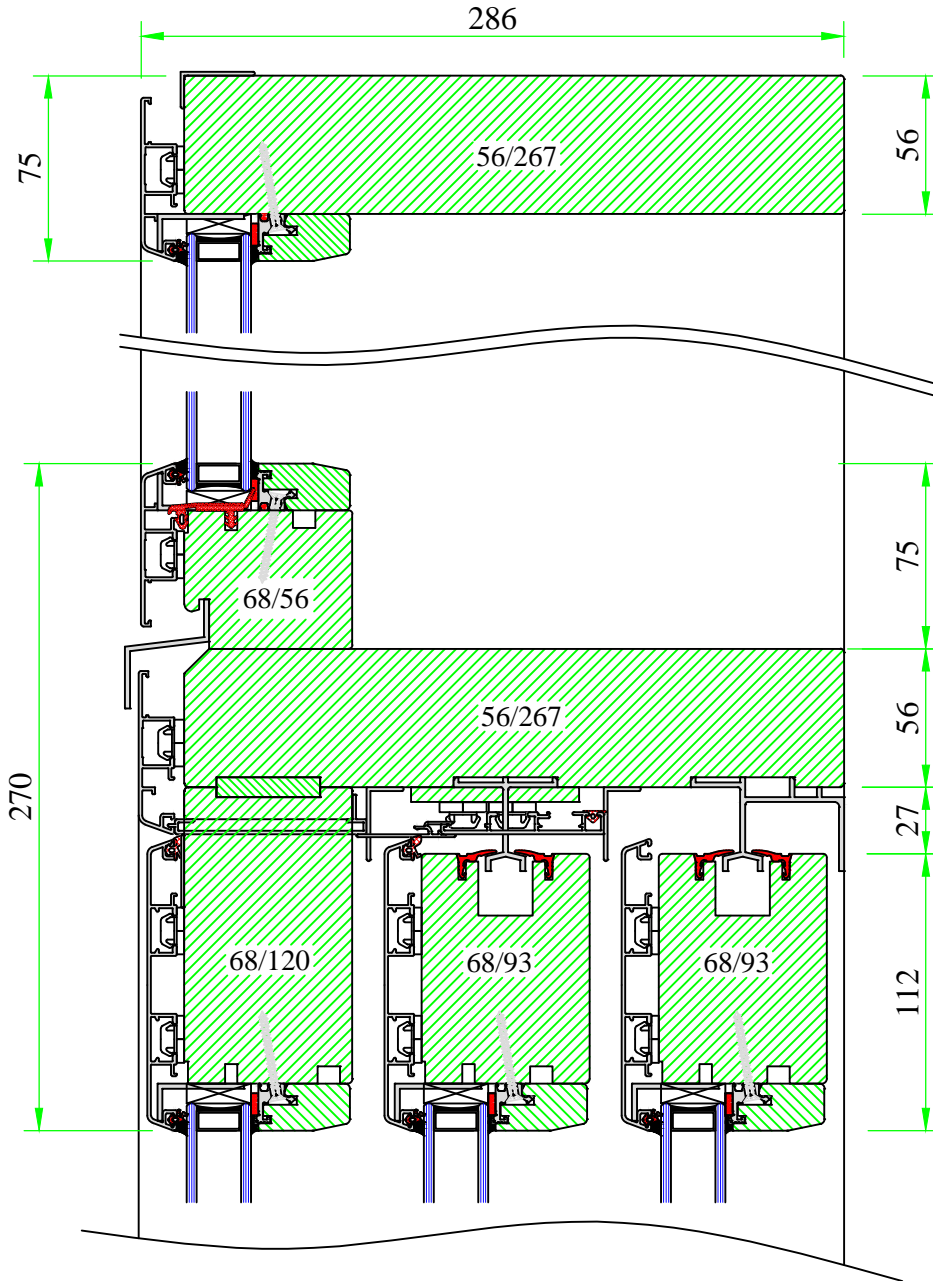
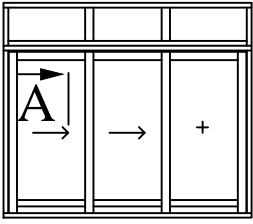

UNI WINDOWS Ltd.
 Unit 6, Edgefield Industrial Est.
 Loanhead, EH20 9TB
 Tel.: 0131 448 3931

MARCONI 1 / 2
 Lift and slide patio door with fixed top light
 - type E

Version: 1	Scale: 1:3
Date: 15.05.14	Drawing: NMHS/8-1

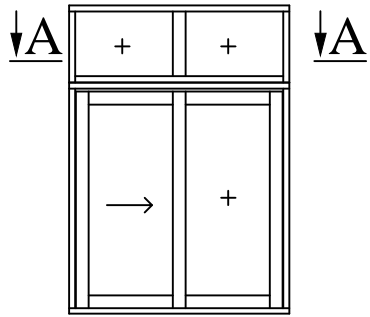

A-A

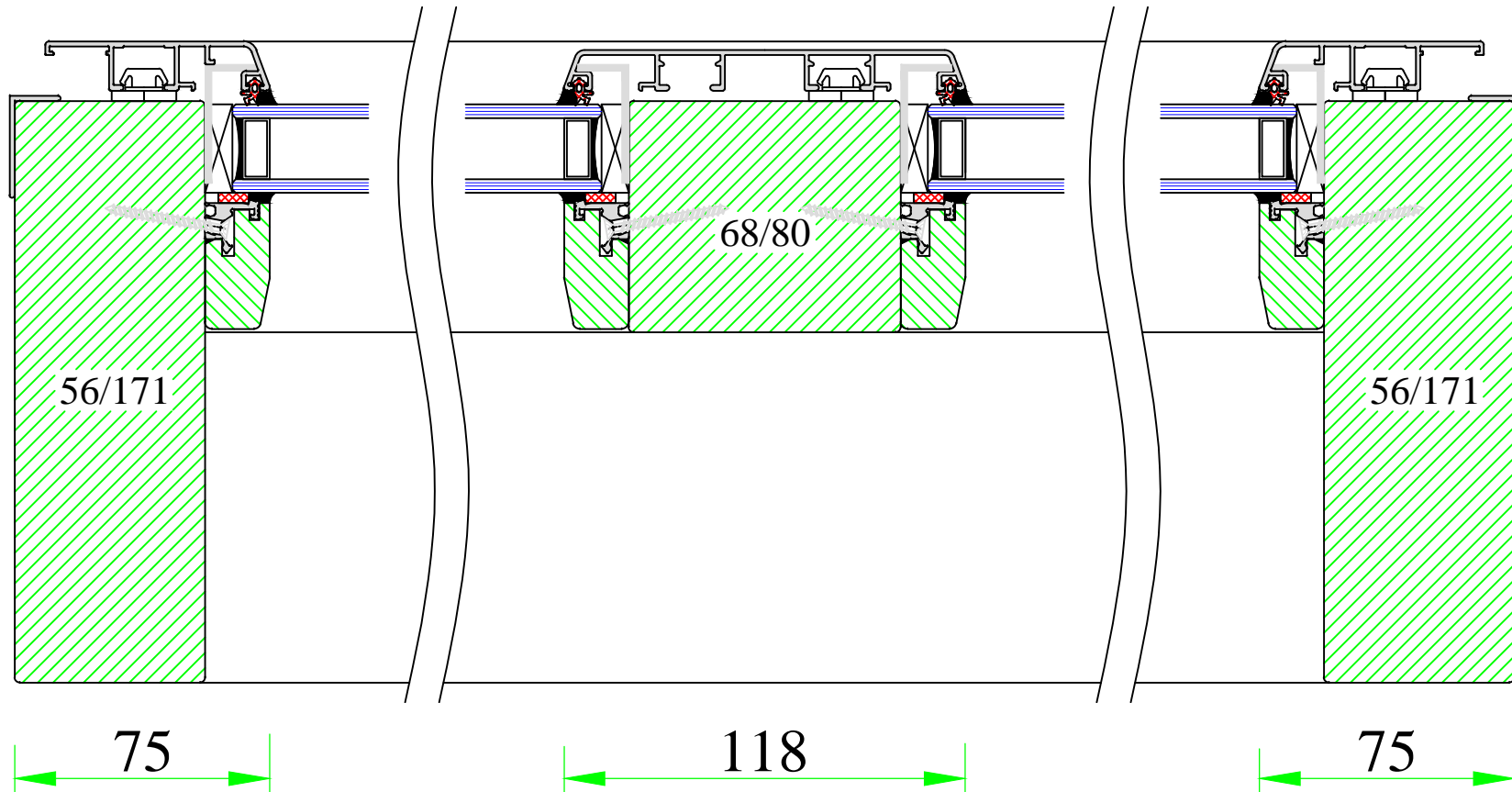

UNI WINDOWS Ltd.
 Unit 6, Edgefield Industrial Est.
 Loanhead, EH20 9TB
 Tel.: 0131 448 3931

MARCONI 1 / 2
 Lift and slide patio door with fixed top light

Version: 1	Scale: 1:2
Date: 15.05.14	Drawing: NMHS/9

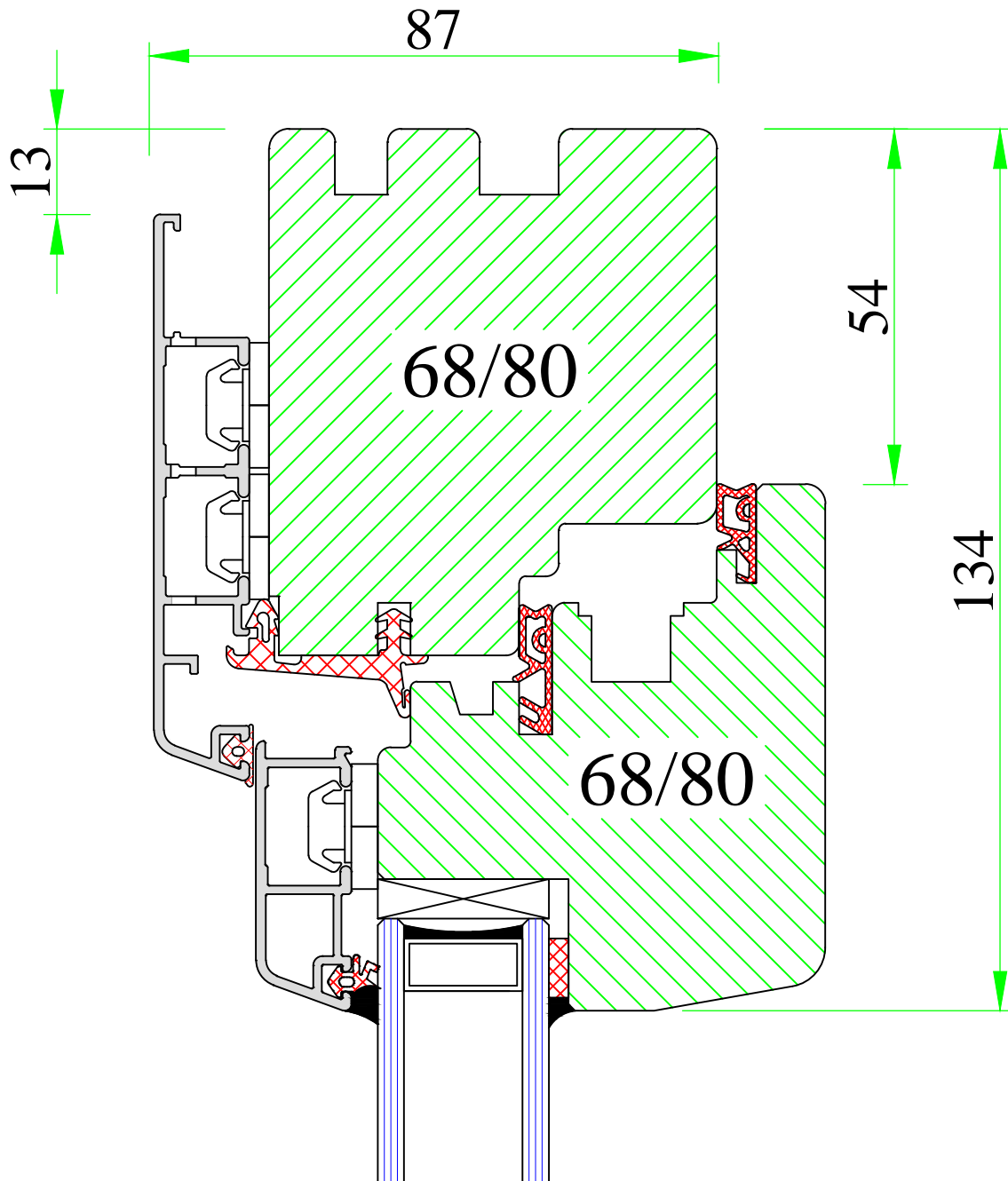
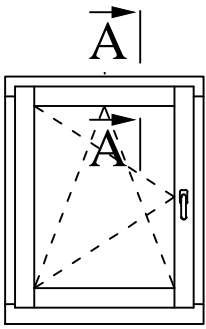

www.uniwin.co.uk



UNI WINDOWS Ltd.
 Unit 6, Edgefield Industrial Est.
 Loanhead, EH20 9TB
 Tel.: 0131 448 3931

MARCONI 1
 Frame-sash connection – top and sides

Version: 1	Scale: 1:1
Date: 15.05.14	Drawing: NM/1

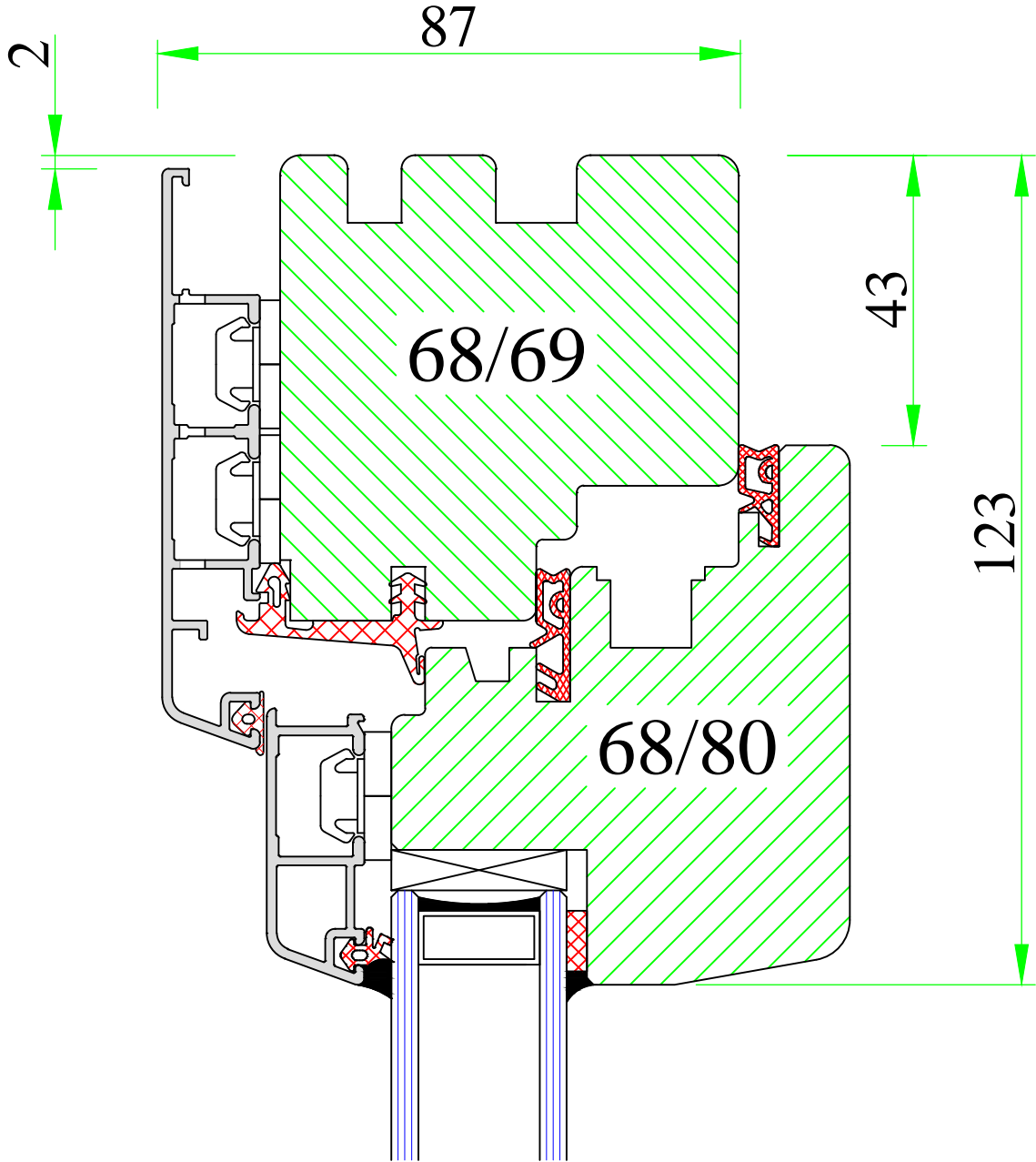
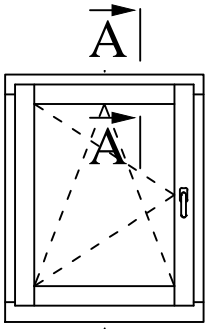

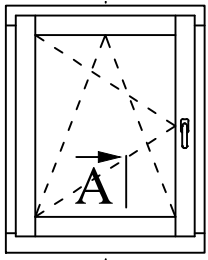

A

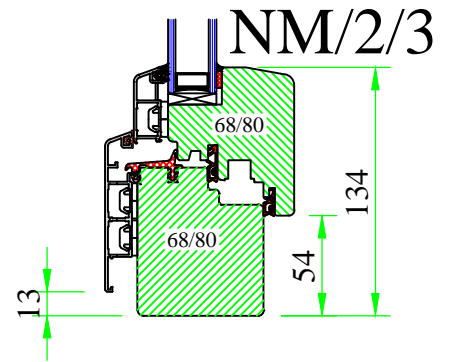
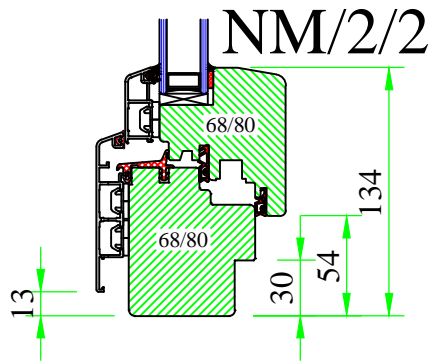
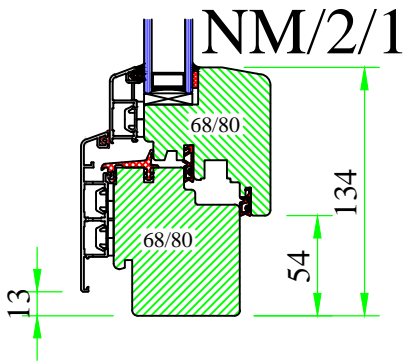
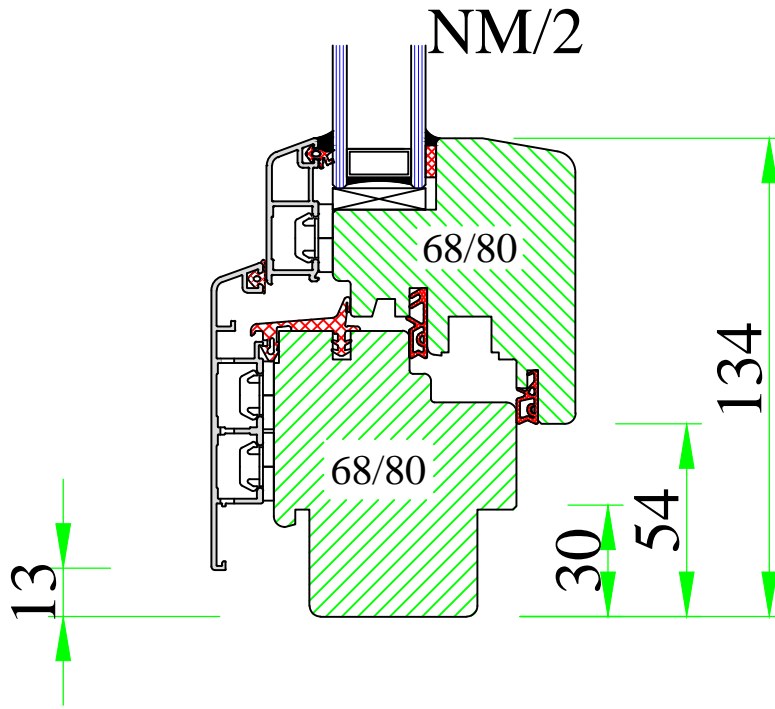

UNI WINDOWS Ltd.
 Unit 6, Edgefield Industrial Est.
 Loanhead, EH20 9TB
 Tel.: 0131 448 3931

MARCONI 1
 Frame-sash connection – undercut options

Version: 1	Scale: 1:2
Date: 15.05.14	Drawing: NM/2

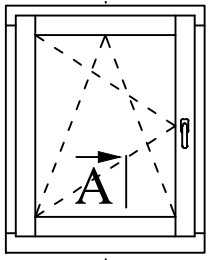

A

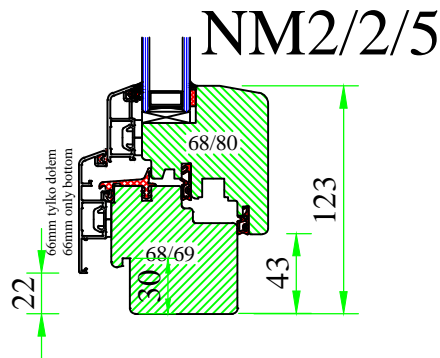
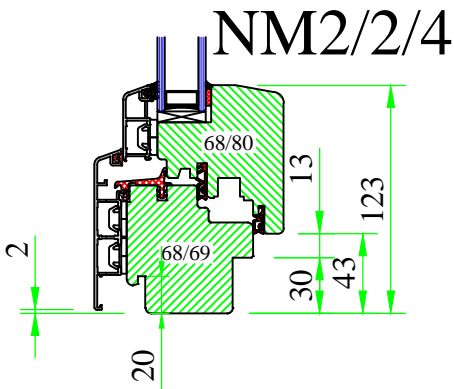
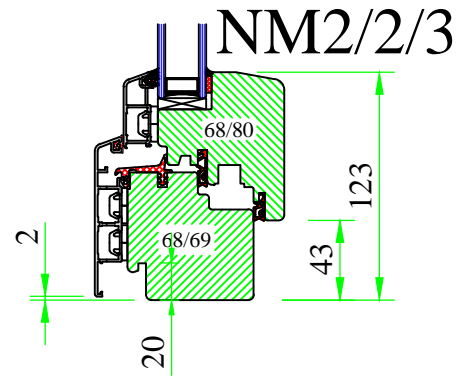
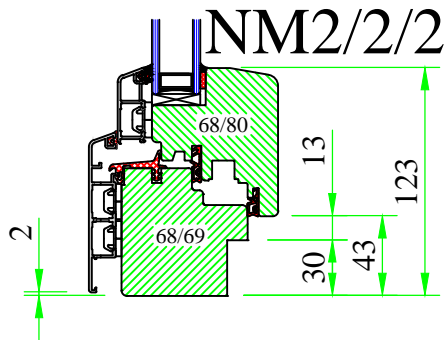
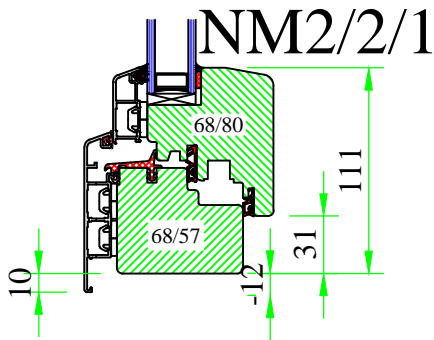
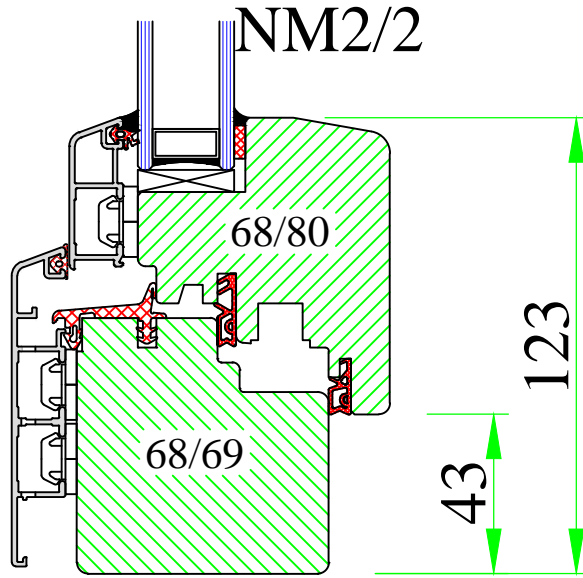

UNI WINDOWS Ltd.
 Unit 6, Edgefield Industrial Est.
 Loanhead, EH20 9TB
 Tel.: 0131 448 3931

MARCONI 2
 Frame-sash connection – undercut options

Version:
1
 Date:
15.05.14

Scale:
1:2
 Drawing:
NM2/2

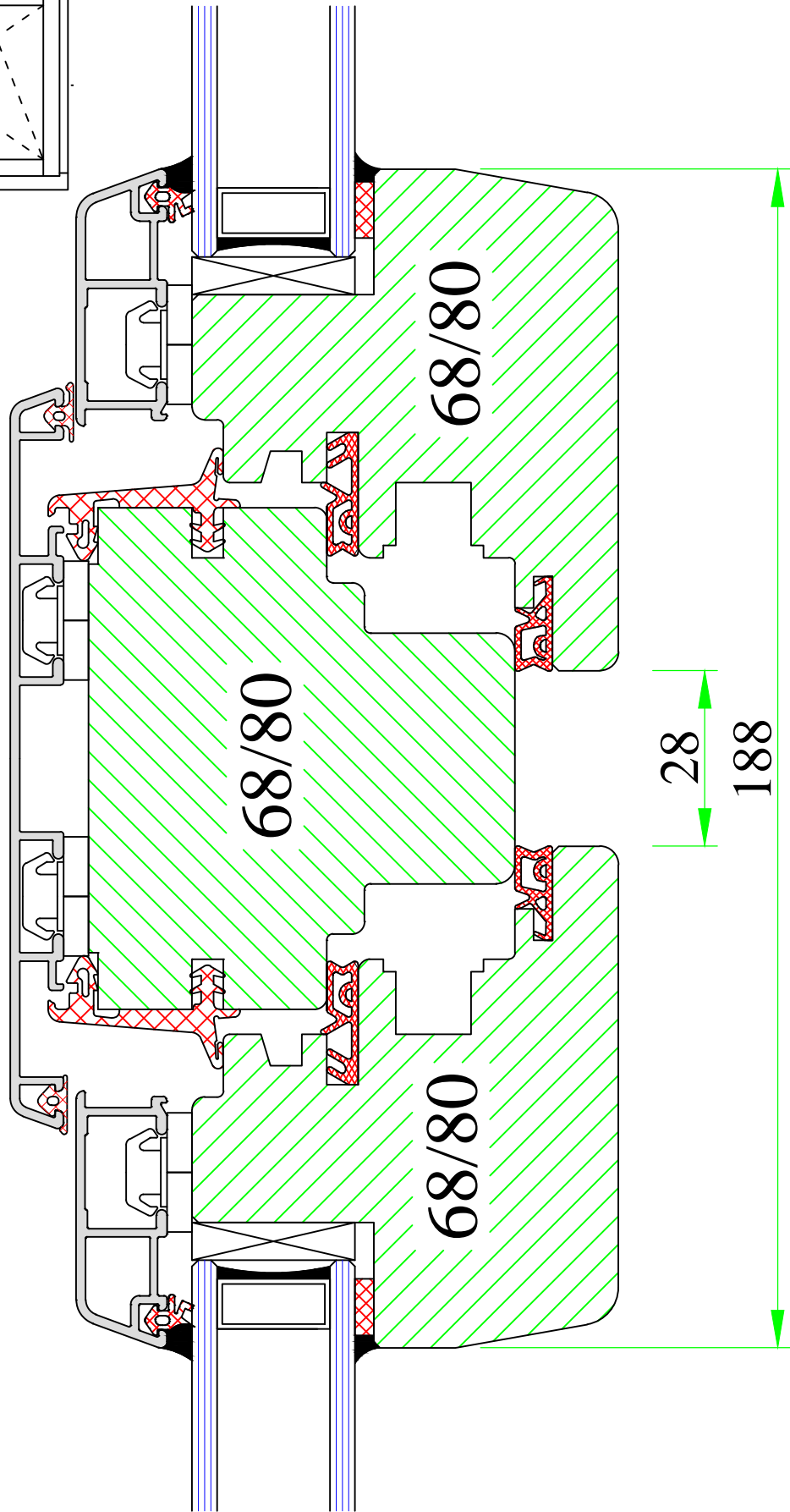
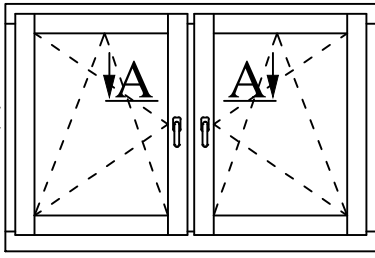

UNI WINDOWS Ltd.
 Unit 6, Edgefield Industrial Est.
 Loanhead, EH20 9TB
 Tel.: 0131 448 3931

MARCONI 1 / 2
 Double opening window – fixed mullion 80mm

Version: 1	Scale: 1:1
Date: 15.05.14	Drawing: NM/3

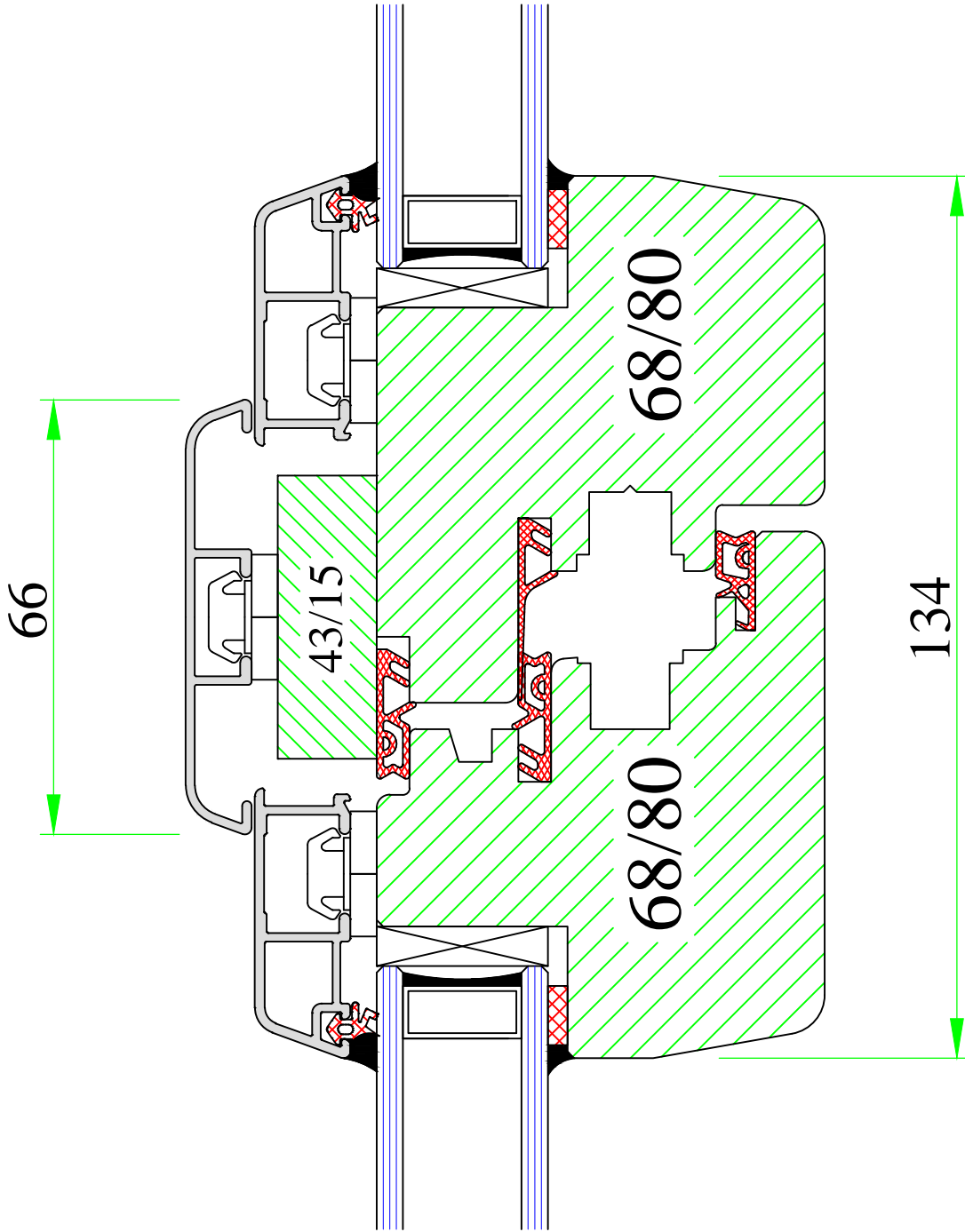
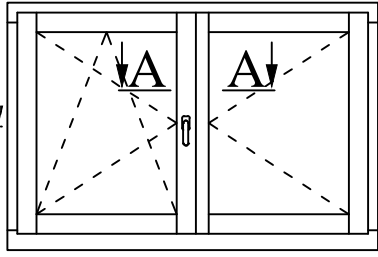

UNI WINDOWS Ltd.
 Unit 6, Edgefield Industrial Est.
 Loanhead, EH20 9TB
 Tel.: 0131 448 3931

'Flying' mullion

MARCONI 1 / 2

Version: 1	Scale: 1:1
Date: 15.05.14	Drawing: MN/5

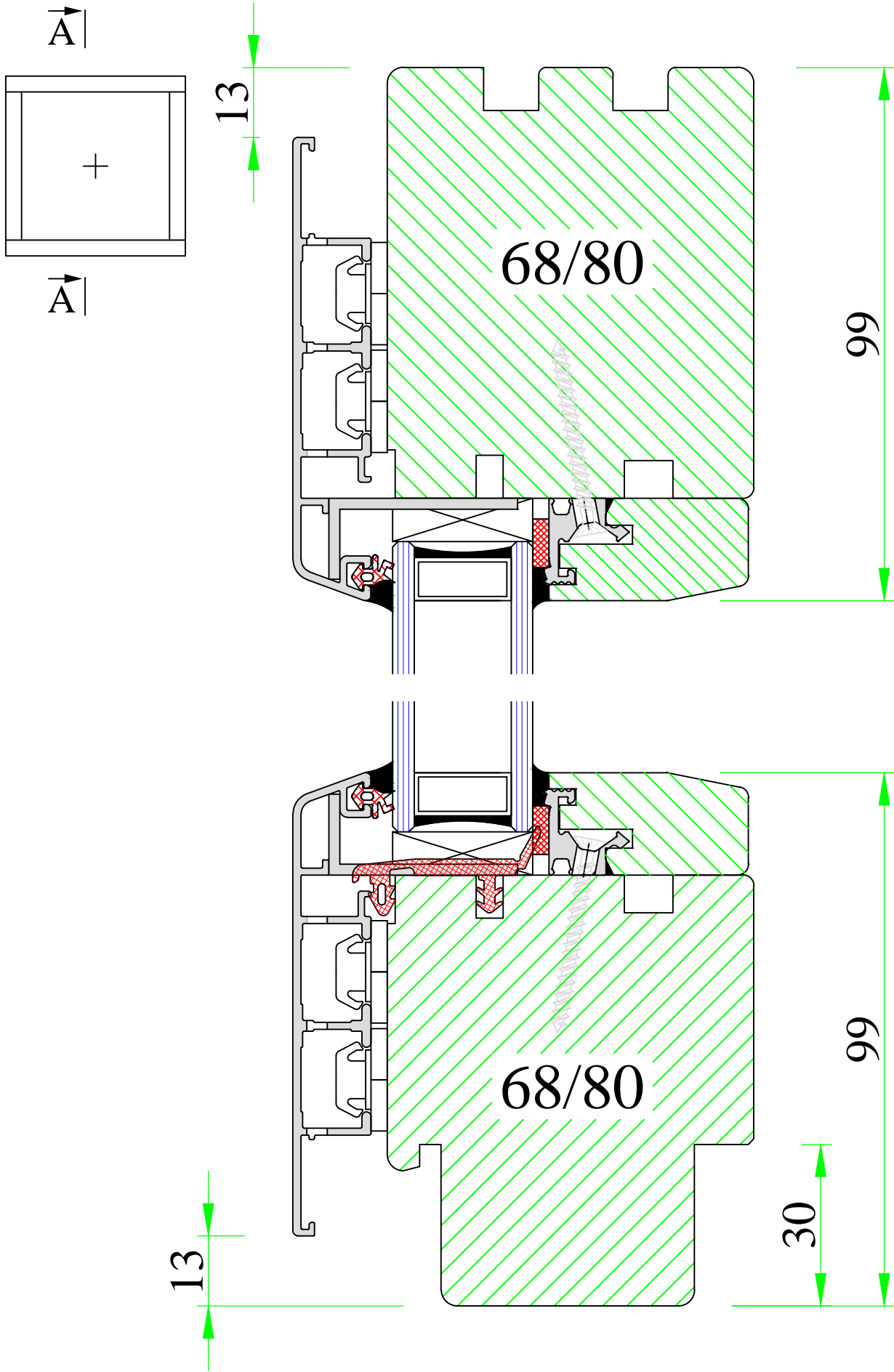

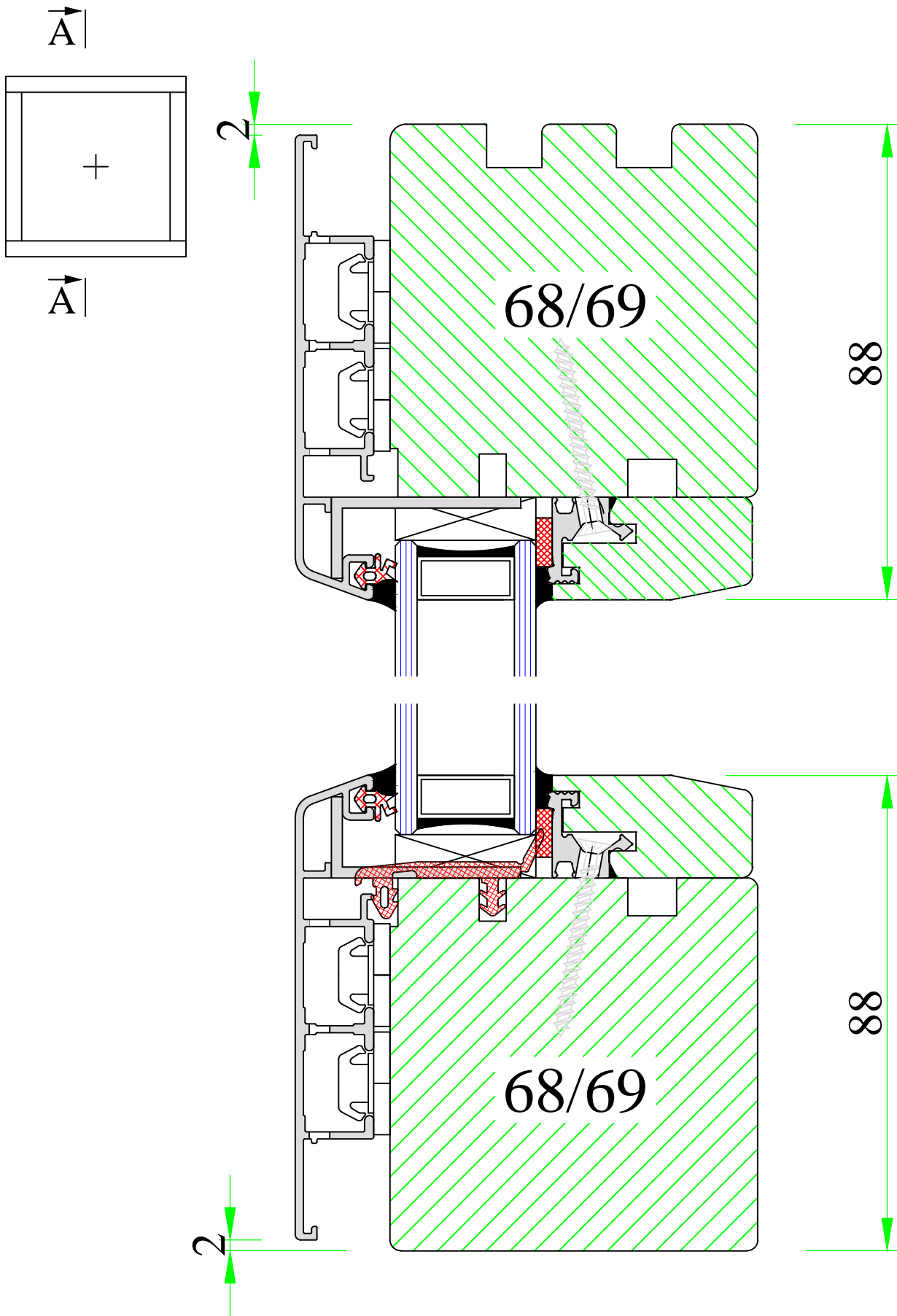

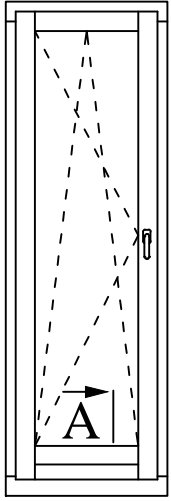

A

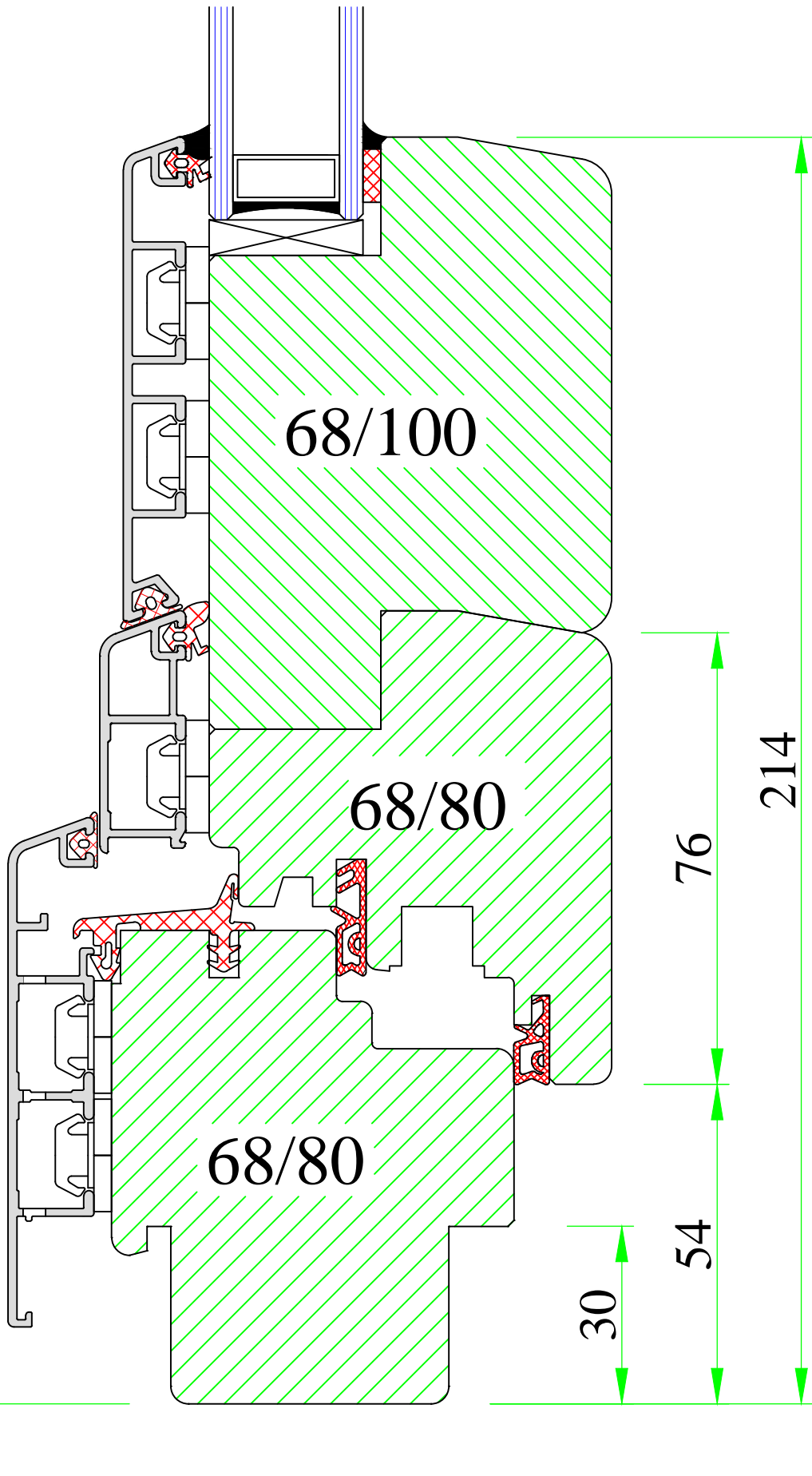

UNI WINDOWS Ltd.
 Unit 6, Edgefield Industrial Est.
 Loanhead, EH20 9TB
 Tel.: 0131 448 3931

MARCONI 1
 Frame-sash connection – undercut of balcony door

Version:
1
 Date:
15.05.14

Scale:
1:1
 Drawing:
NM/7

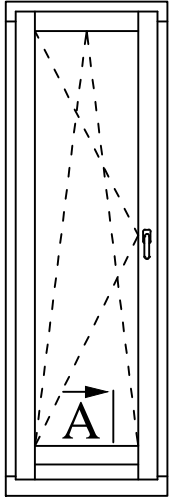

A

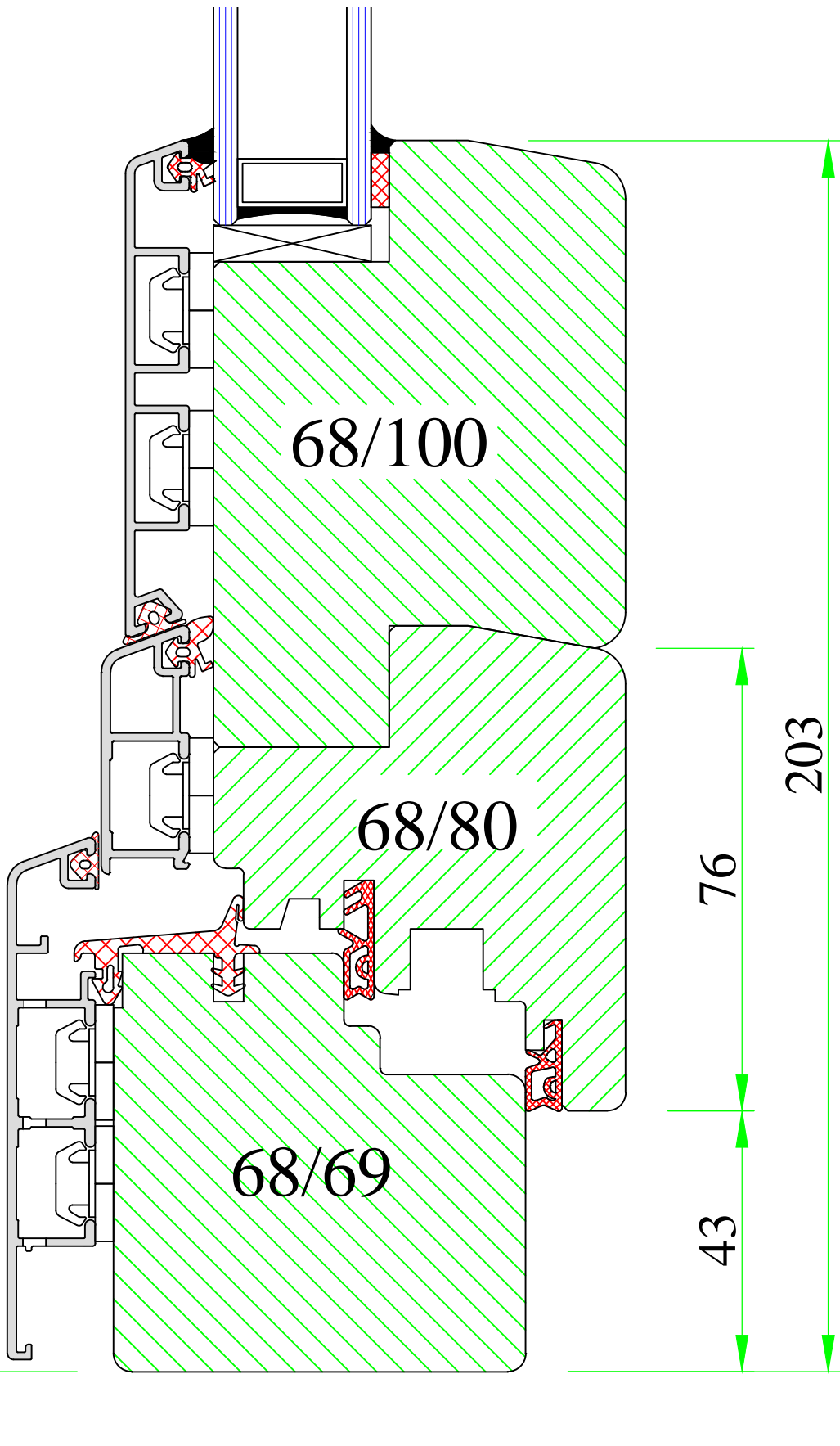

68/100

68/80

68/69

76

43

203



UNI WINDOWS Ltd.
 Unit 6, Edgefield Industrial Est.
 Loanhead, EH20 9TB
 Tel.: 0131 448 3931

MARCONI 2
 Frame-sash connection – undercut of balcony door

Version:
1
 Date:
15.05.14

Scale:
1:1
 Drawing:
NM2/7

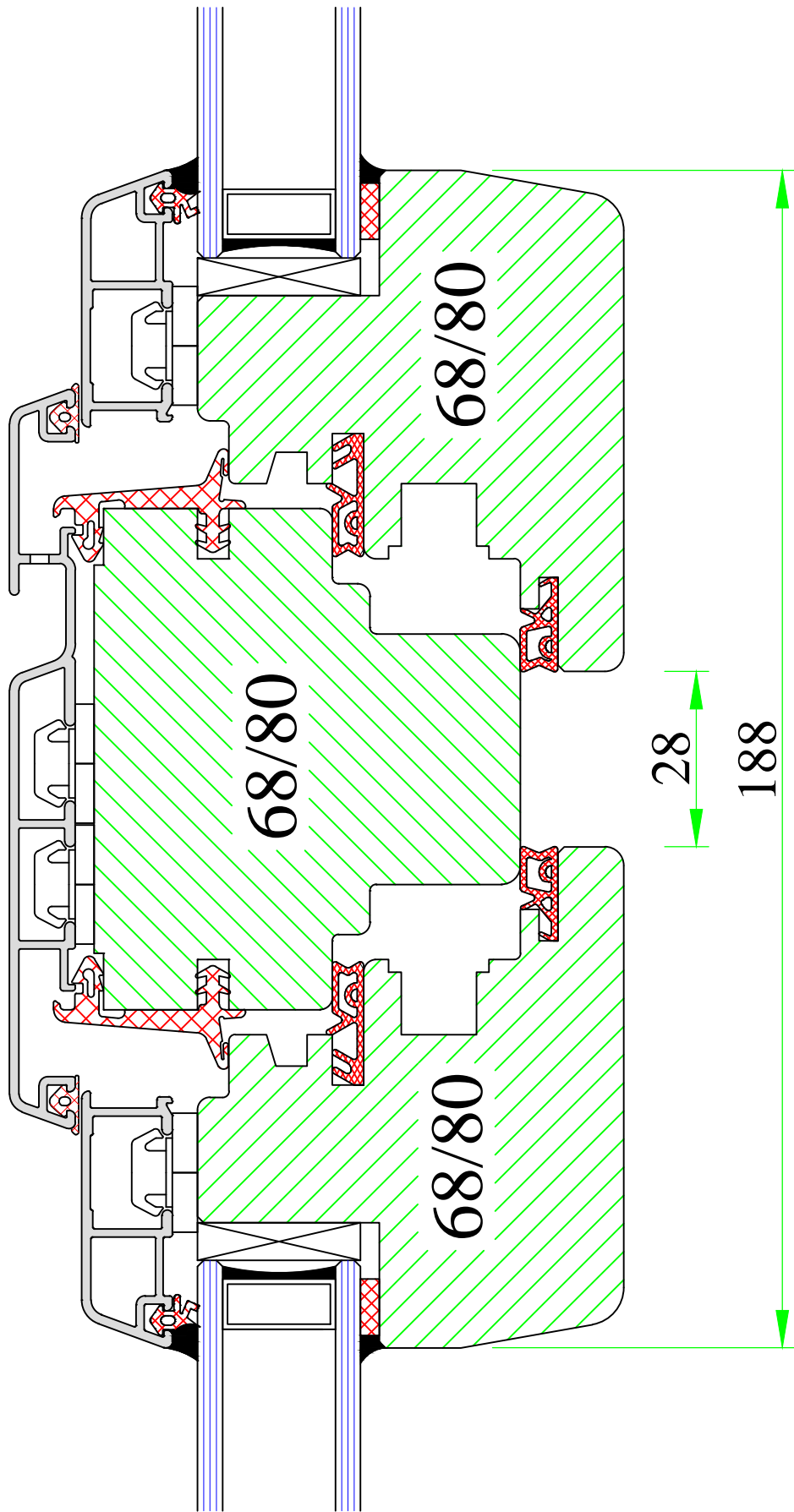
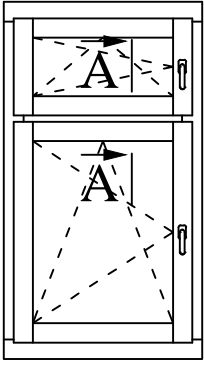

UNI WINDOWS Ltd.
 Unit 6, Edgefield Industrial Est.
 Loanhead, EH20 9TB
 Tel.: 0131 448 3931

MARCONI
 Bottom and top sash – transom 80mm

Version: 1	Scale: 1:1
Date: 15.05.14	Drawing: NM/8

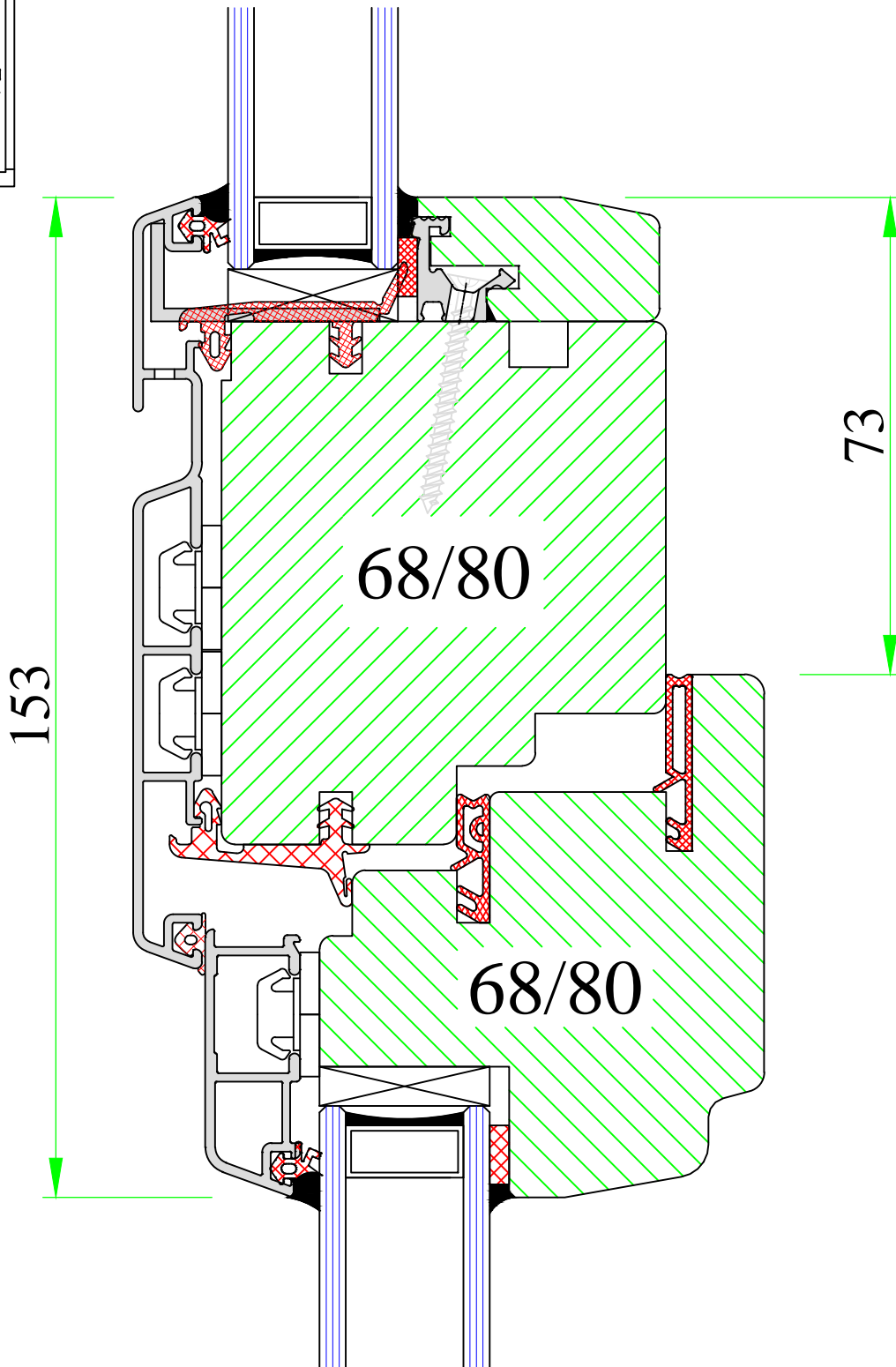
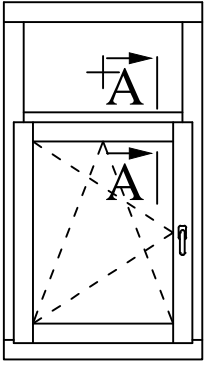

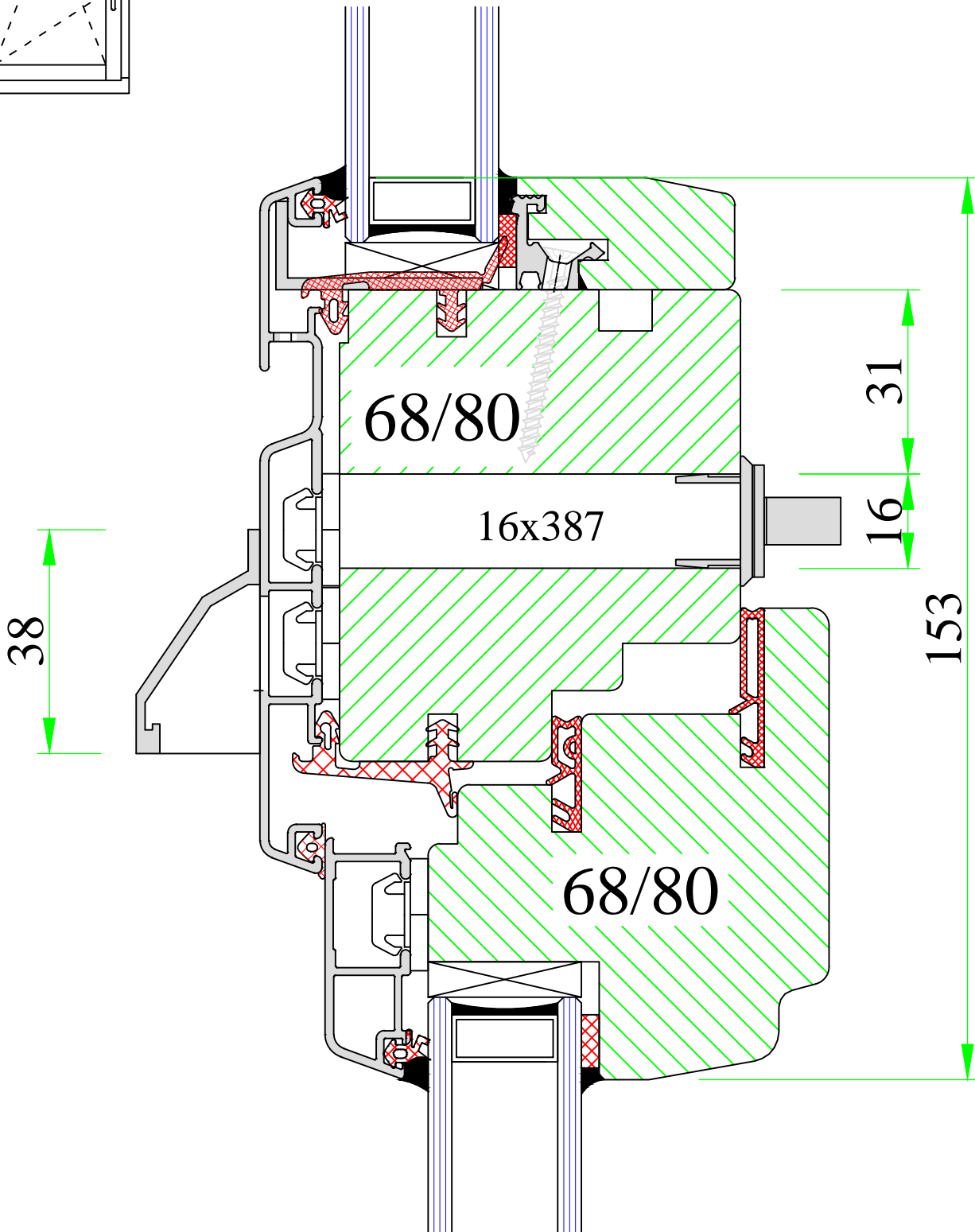
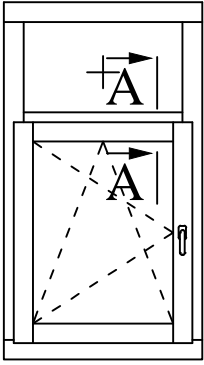

UNI WINDOWS Ltd.
 Unit 6, Edgefield Industrial Est.
 Loanhead, EH20 9TB
 Tel.: 0131 448 3931

Ventilator TV-90

MARCONI 1 / 2

Version:
1

Scale:
1:1

Date:
15.05.14

Drawing:
NM/9-1

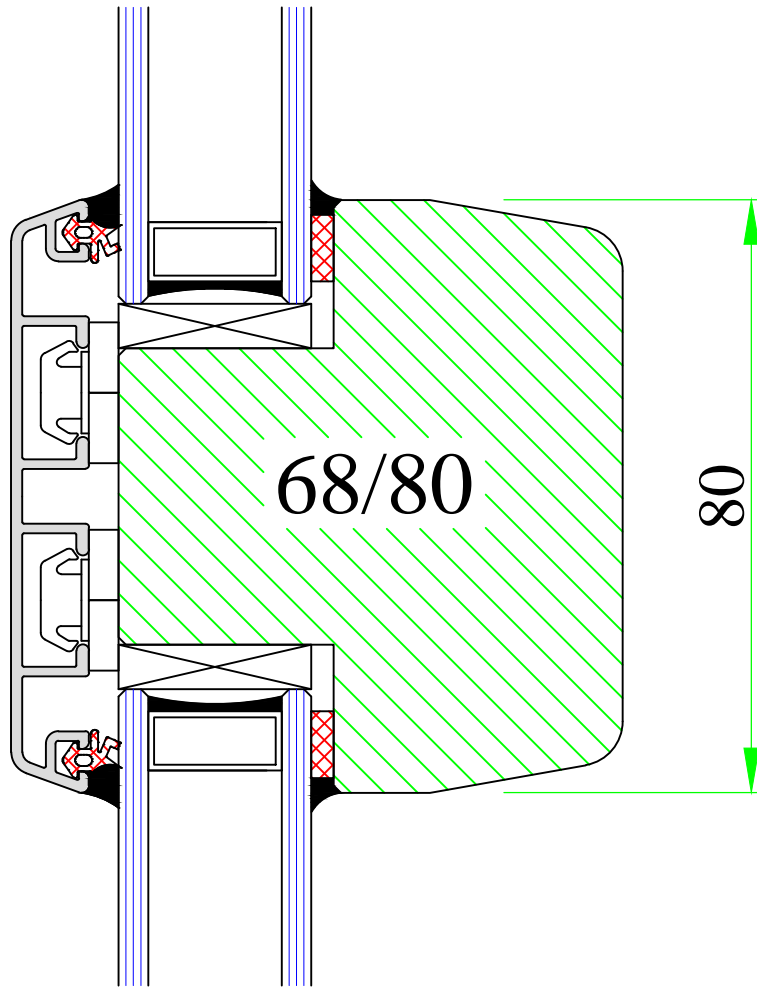
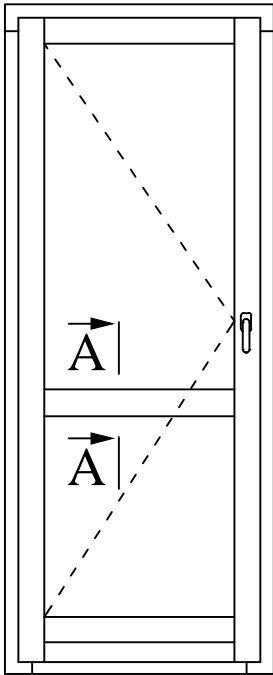

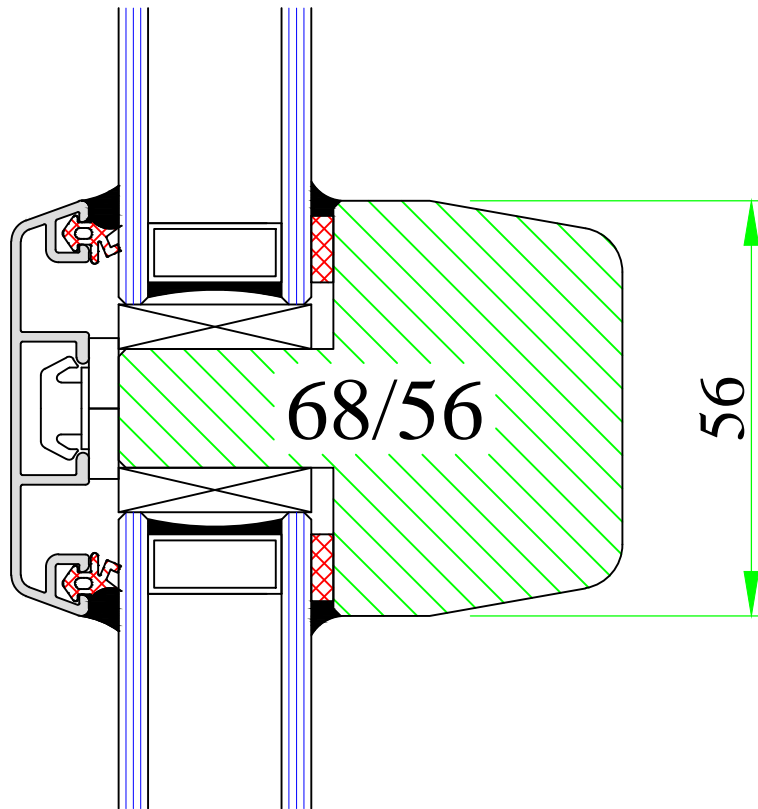
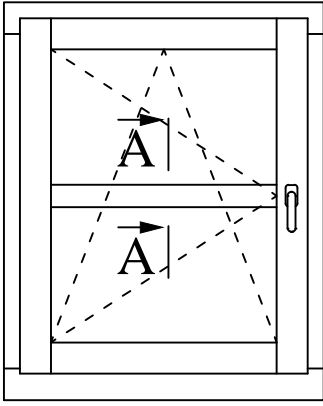

UNI WINDOWS Ltd.
 Unit 6, Edgefield Industrial Est.
 Loanhead, EH20 9TB
 Tel.: 0131 448 3931

MARCONI 1 / 2
 Astragal construction – 56mm profile

Version: 1	Scale: 1:1
Date: 15.05.14	Drawing: NM/13

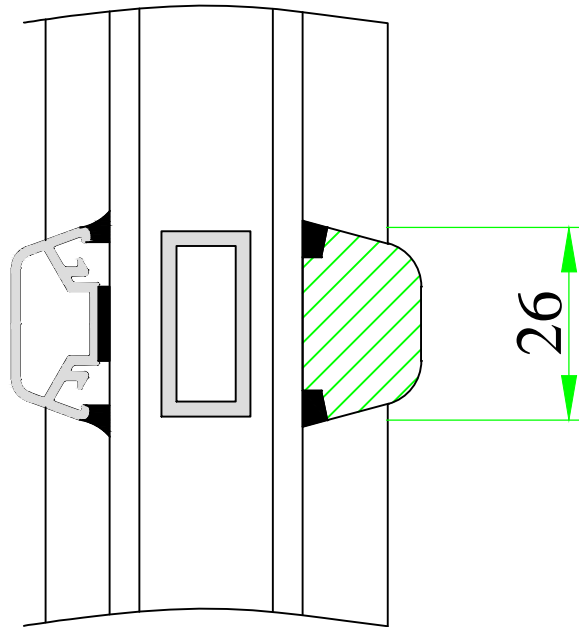
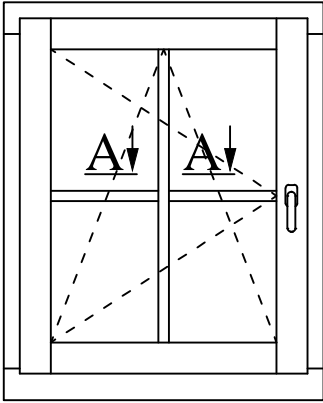

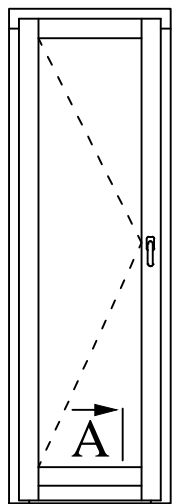

A

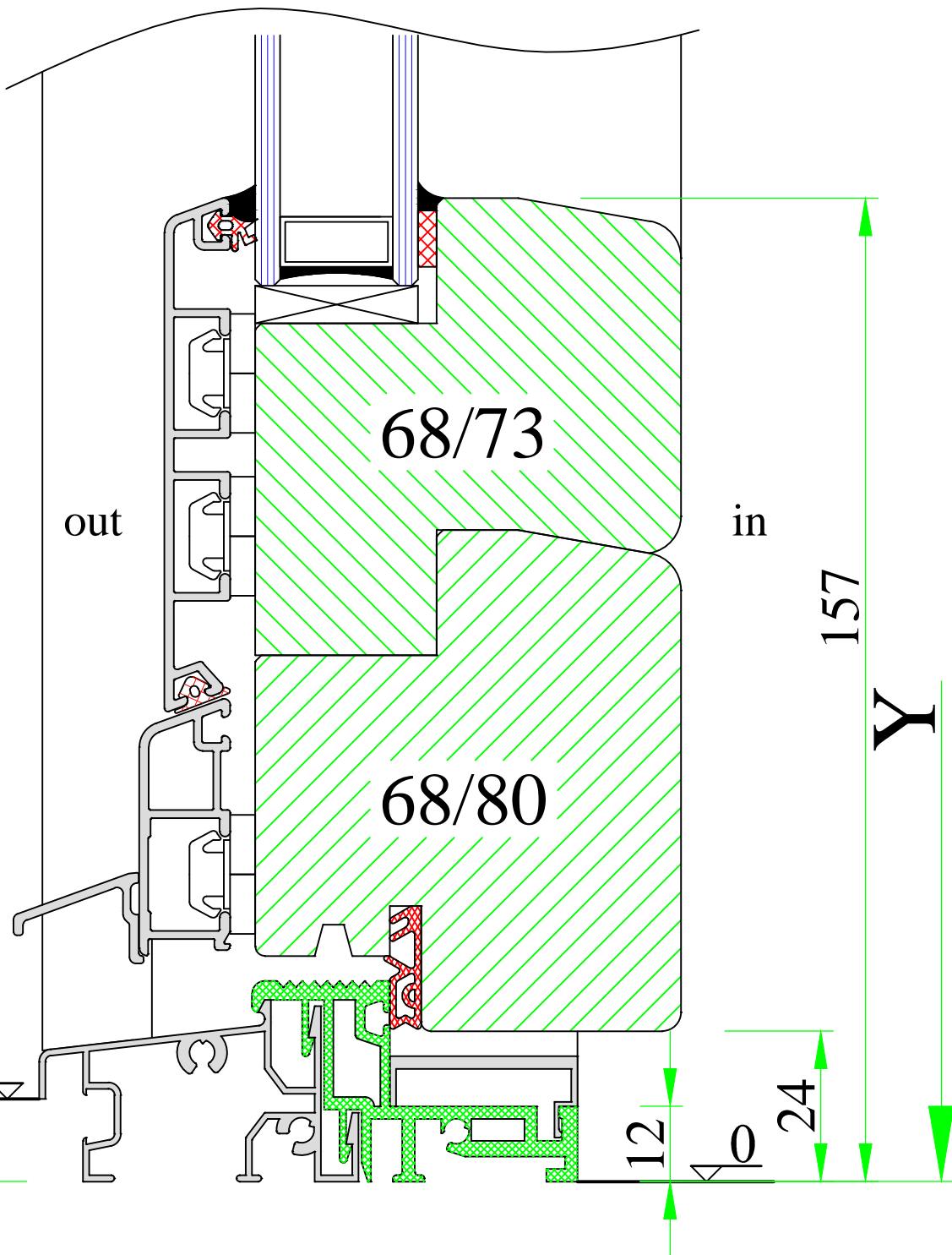

www.uniwin.co.uk



UNI WINDOWS Ltd.
 Unit 6, Edgefield Industrial Est.
 Loanhead, EH20 9TB
 Tel.: 0131 448 3931

MARCONI 1 / 2

Balcony door with flat threshold

Version:
1

Scale:
1:1

Date:
15.05.14

Drawing:
NM/18

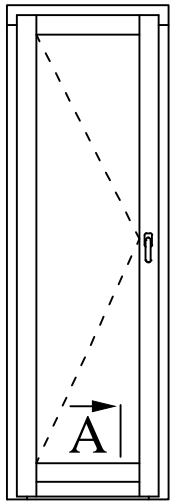

A

out

68/91

in

68/80

157

Y

14

6

0



UNI WINDOWS Ltd.
 Unit 6, Edgefield Industrial Est.
 Loanhead, EH20 9TB
 Tel.: 0131 448 3931

MARCONI 1 / 2

Balcony door with Weser threshold –
 – T&T version

Version:
1

Scale:
1:1

Date:
15.05.14

Drawing:
NM/18-1

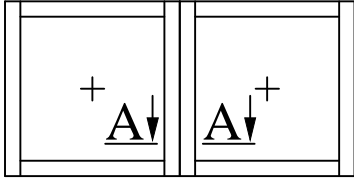

40

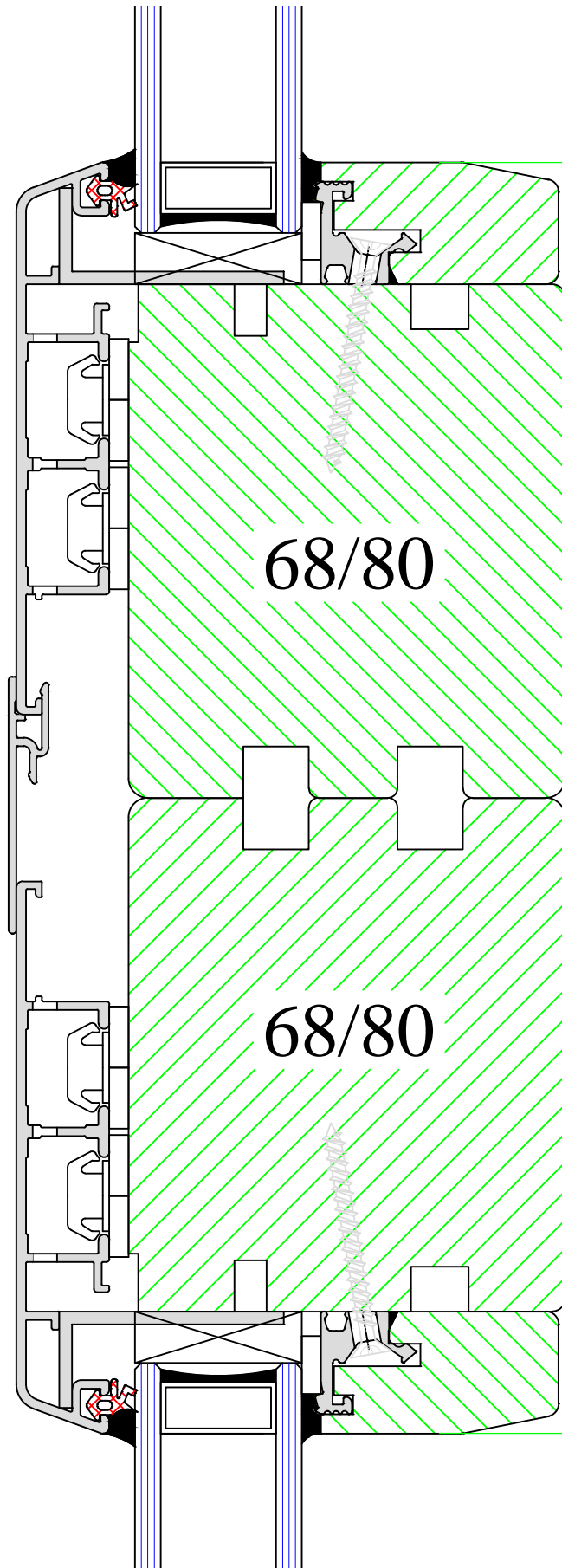

198



UNI WINDOWS Ltd.
 Unit 6, Edgefield Industrial Est.
 Loanhead, EH20 9TB
 Tel.: 0131 448 3931

MARCONI 1
 Sections connection – vertical

Version: 1	Scale: 1:1
Date: 15.05.14	Drawing: NM/20

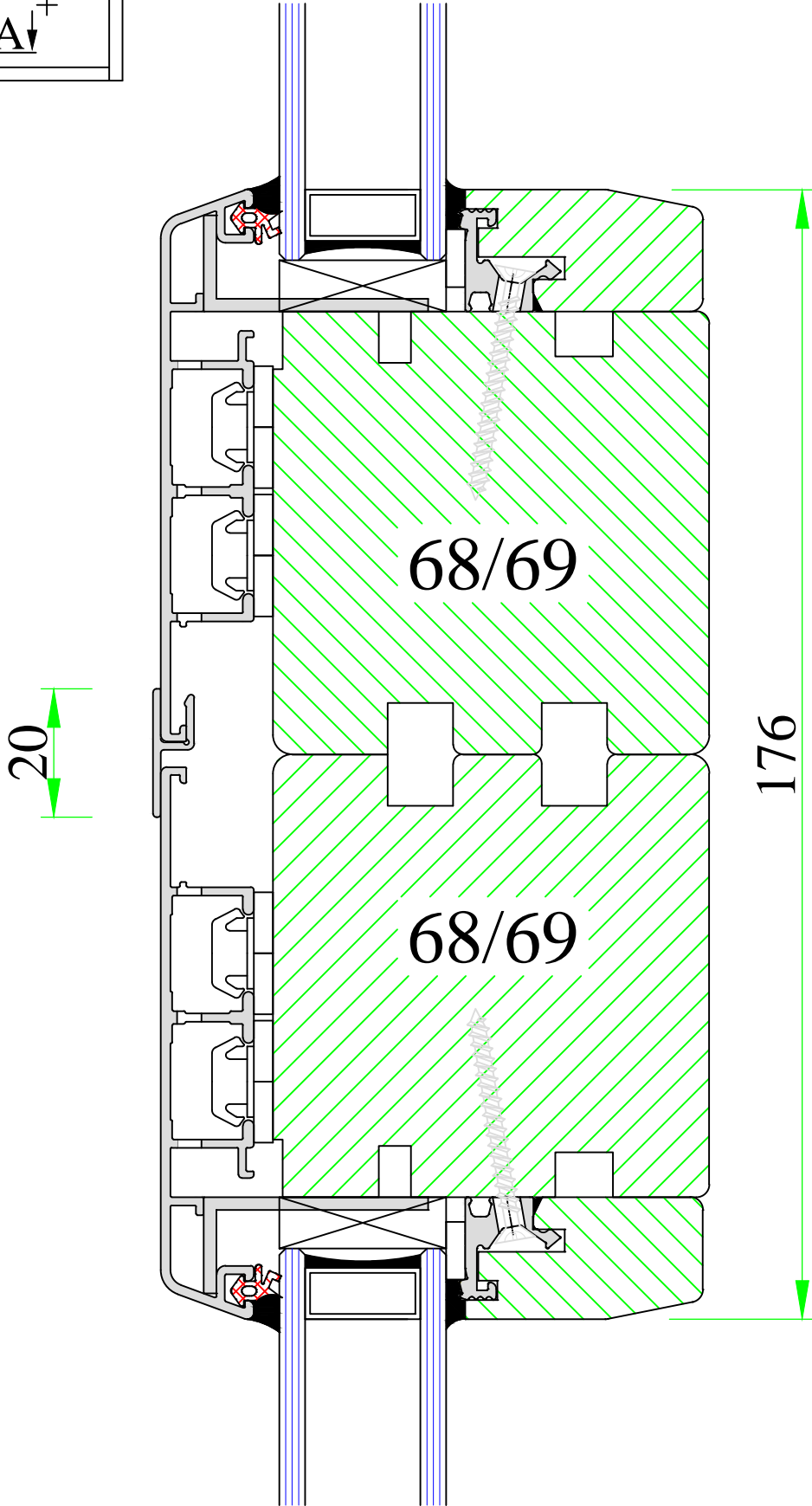
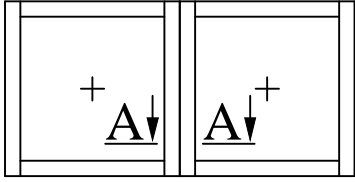

UNI WINDOWS Ltd.
 Unit 6, Edgefield Industrial Est.
 Loanhead, EH20 9TB
 Tel.: 0131 448 3931

Sections connection – vertical

MARCONI 2

Version:
1

Scale:
1:1

Date:
15.05.14

Drawing:
NM2/20

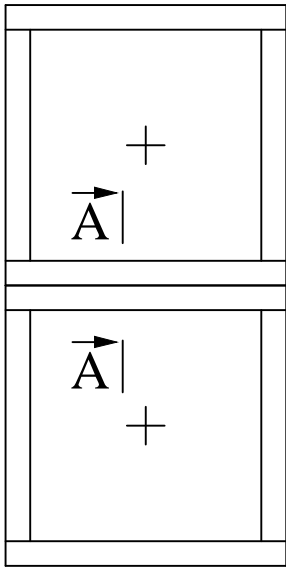

25

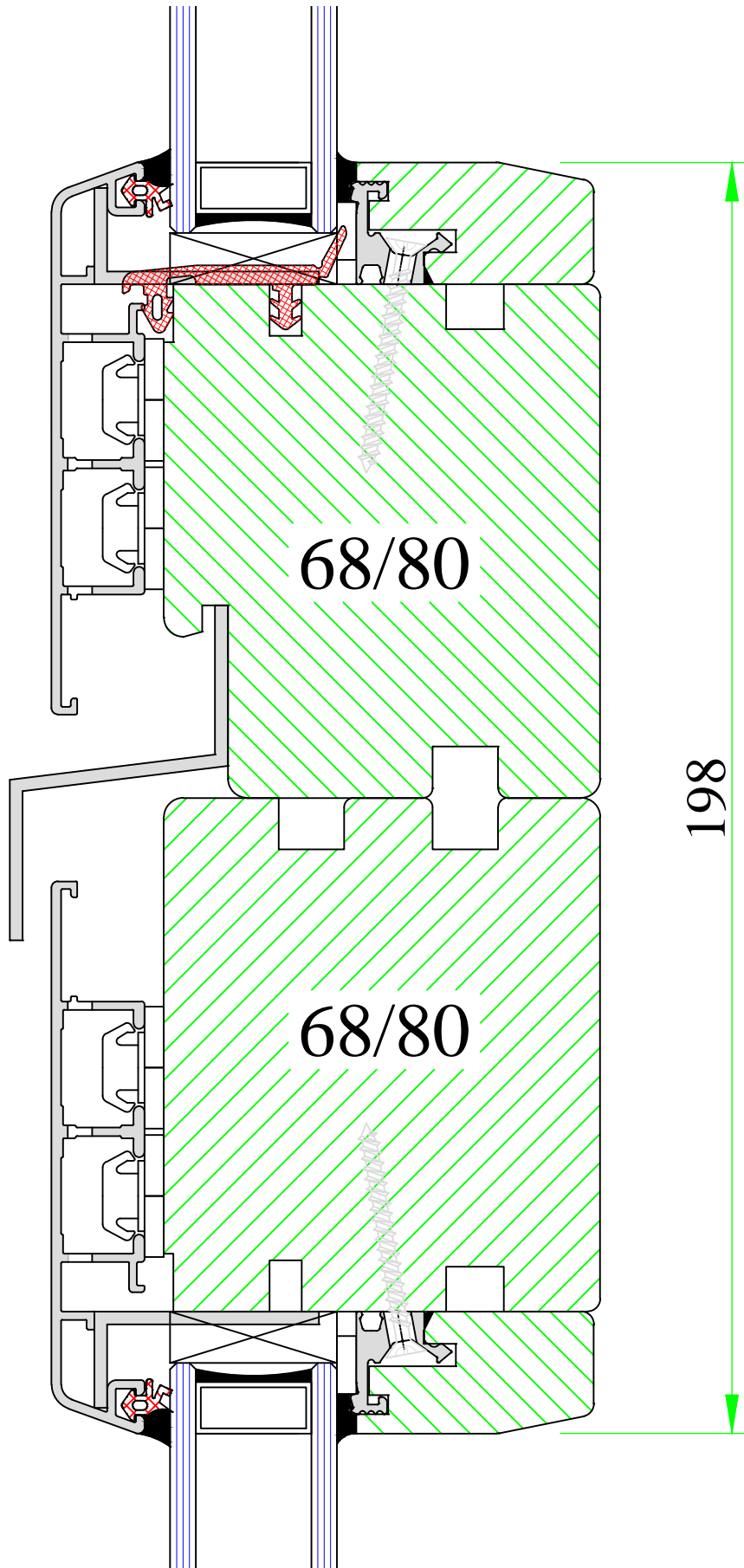

198



UNI WINDOWS Ltd.
 Unit 6, Edgefield Industrial Est.
 Loanhead, EH20 9TB
 Tel.: 0131 448 3931

MARCONI 1
 Sections connection – horizontal

Version:
1

Date:
15.05.14

Scale:
1:1

Drawing:
NM/20-1

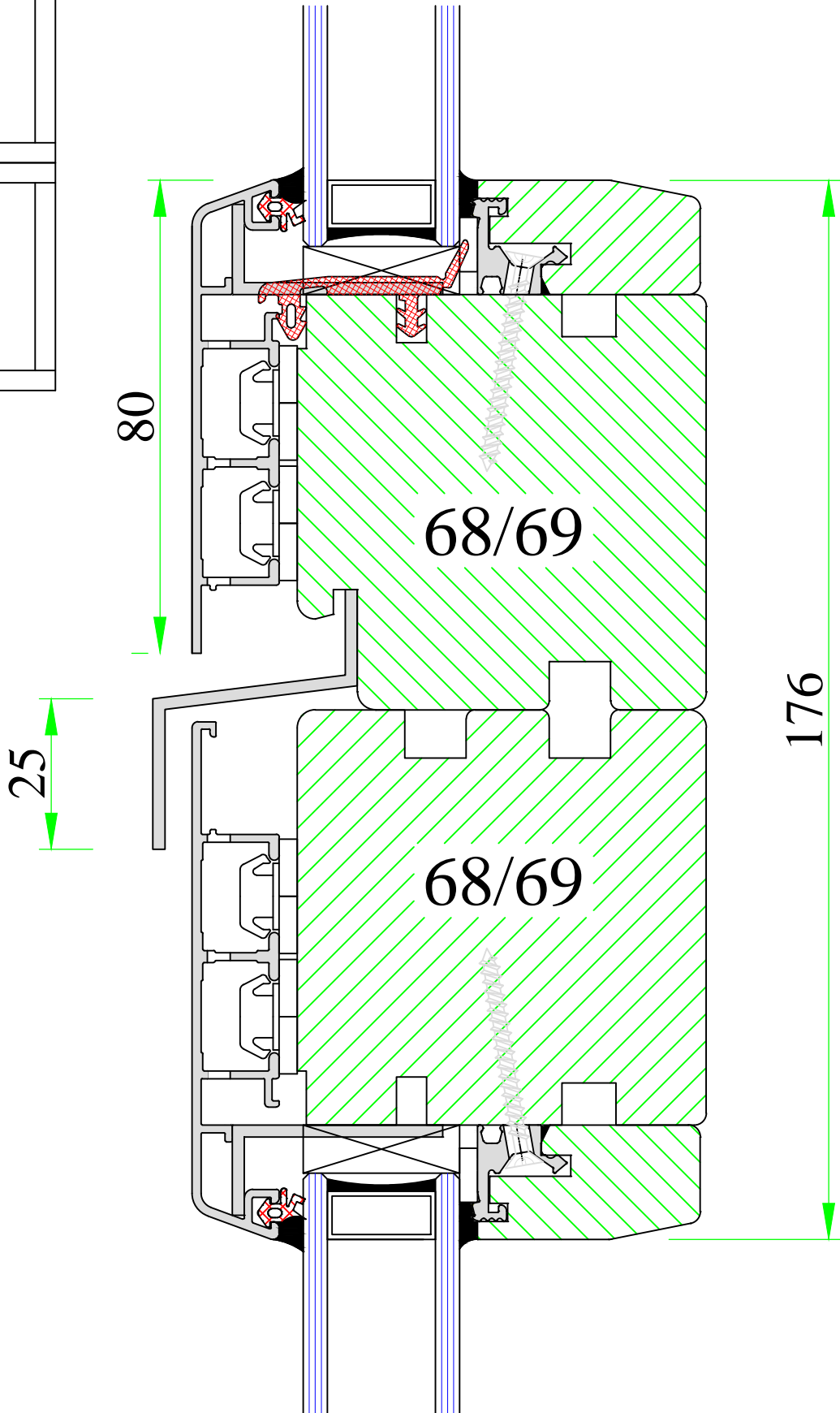
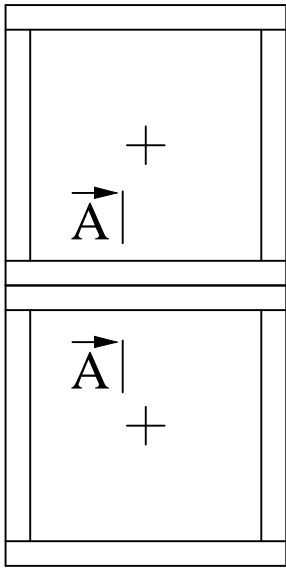

UNI WINDOWS Ltd.
 Unit 6, Edgefield Industrial Est.
 Loanhead, EH20 9TB
 Tel.: 0131 448 3931

MARCONI 2
 Sections connection – horizontal

Version: 1	Scale: 1:1
Date: 15.05.14	Drawing: NM2/20-1

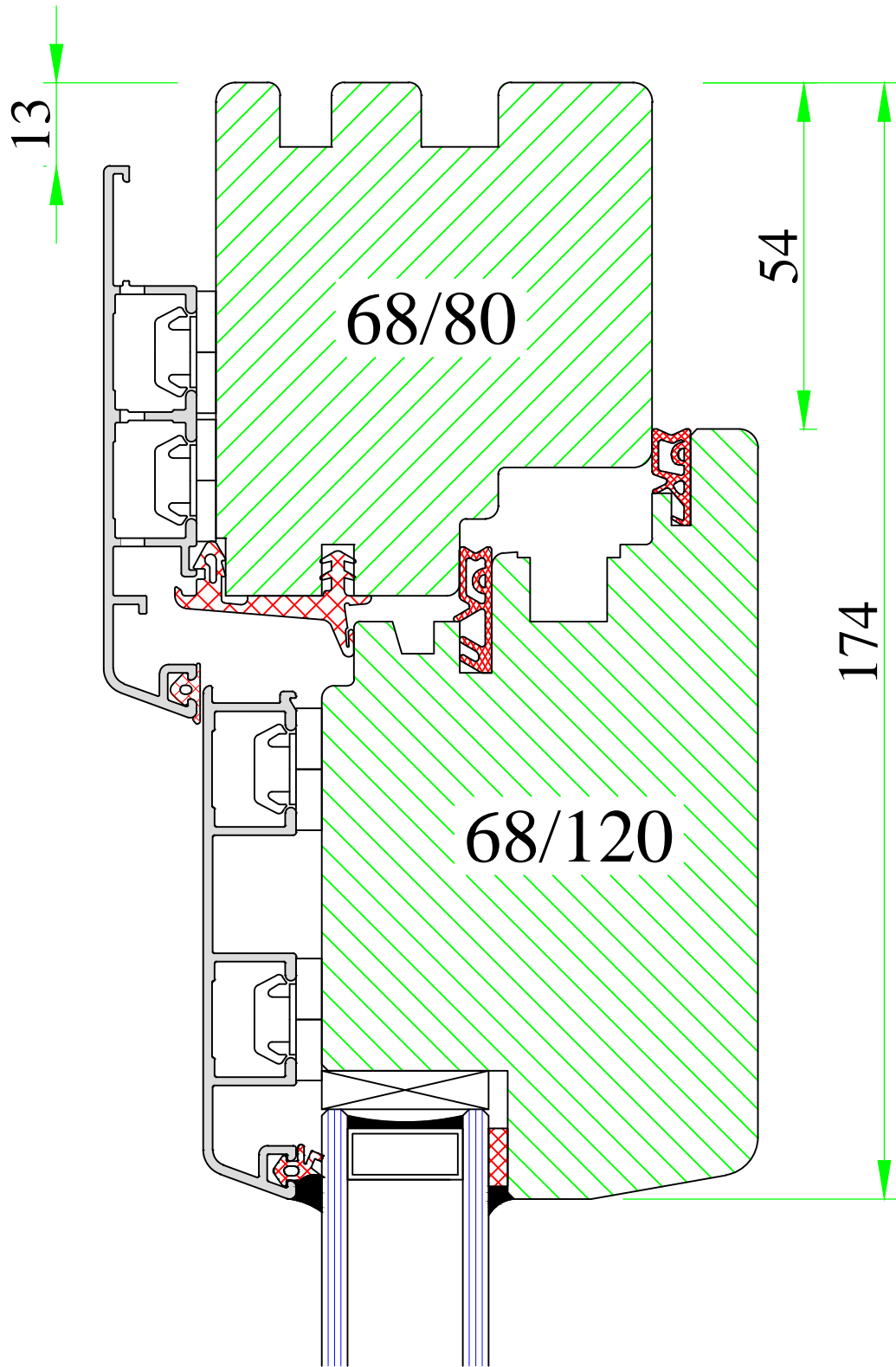
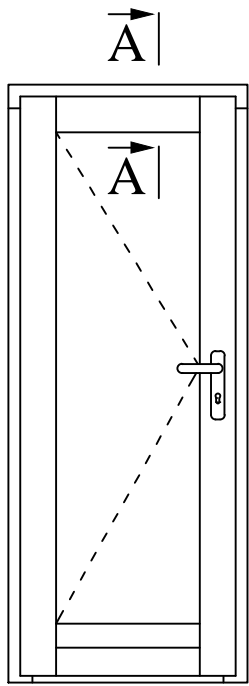

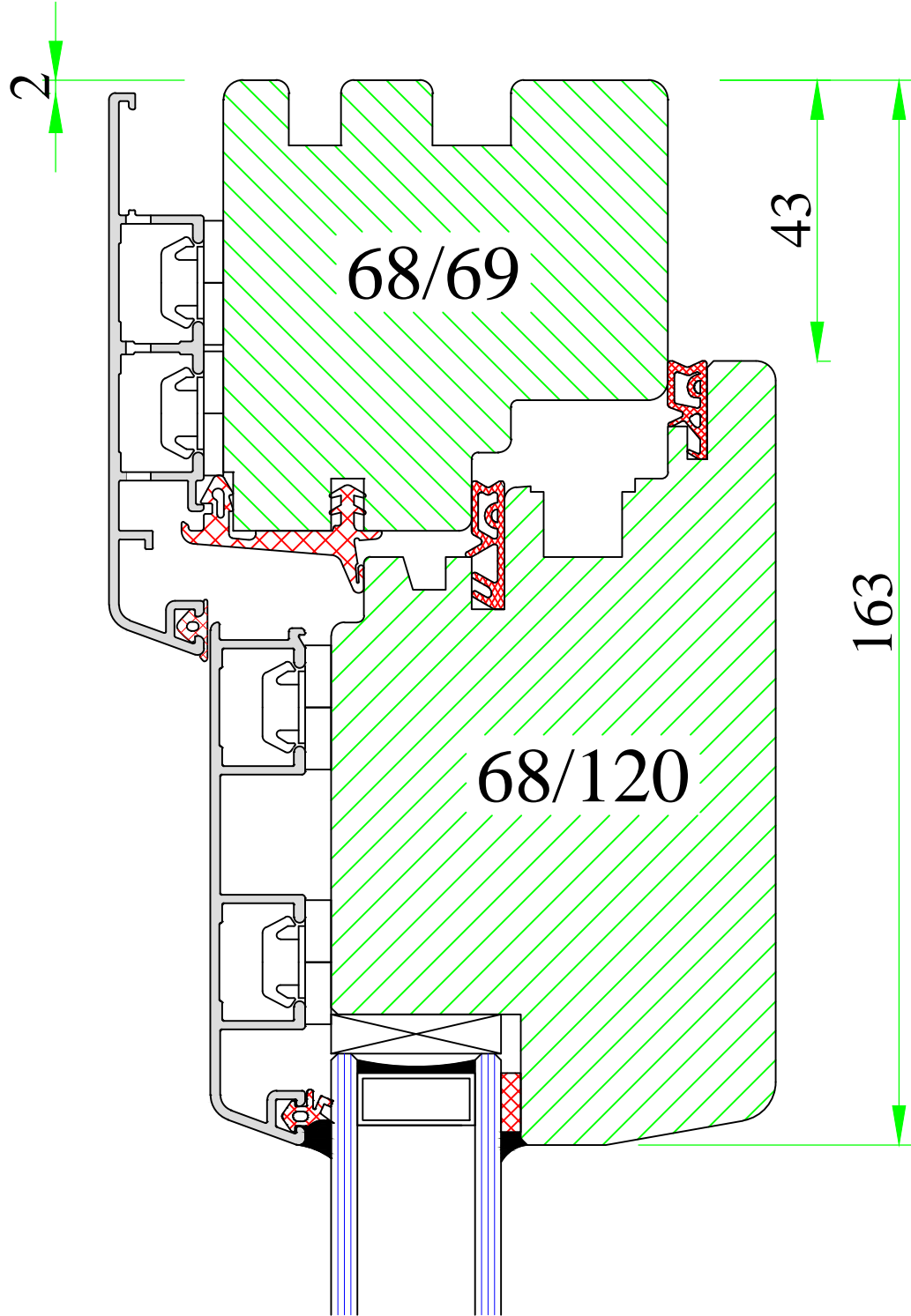
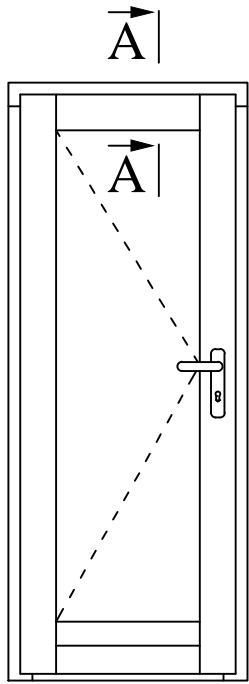

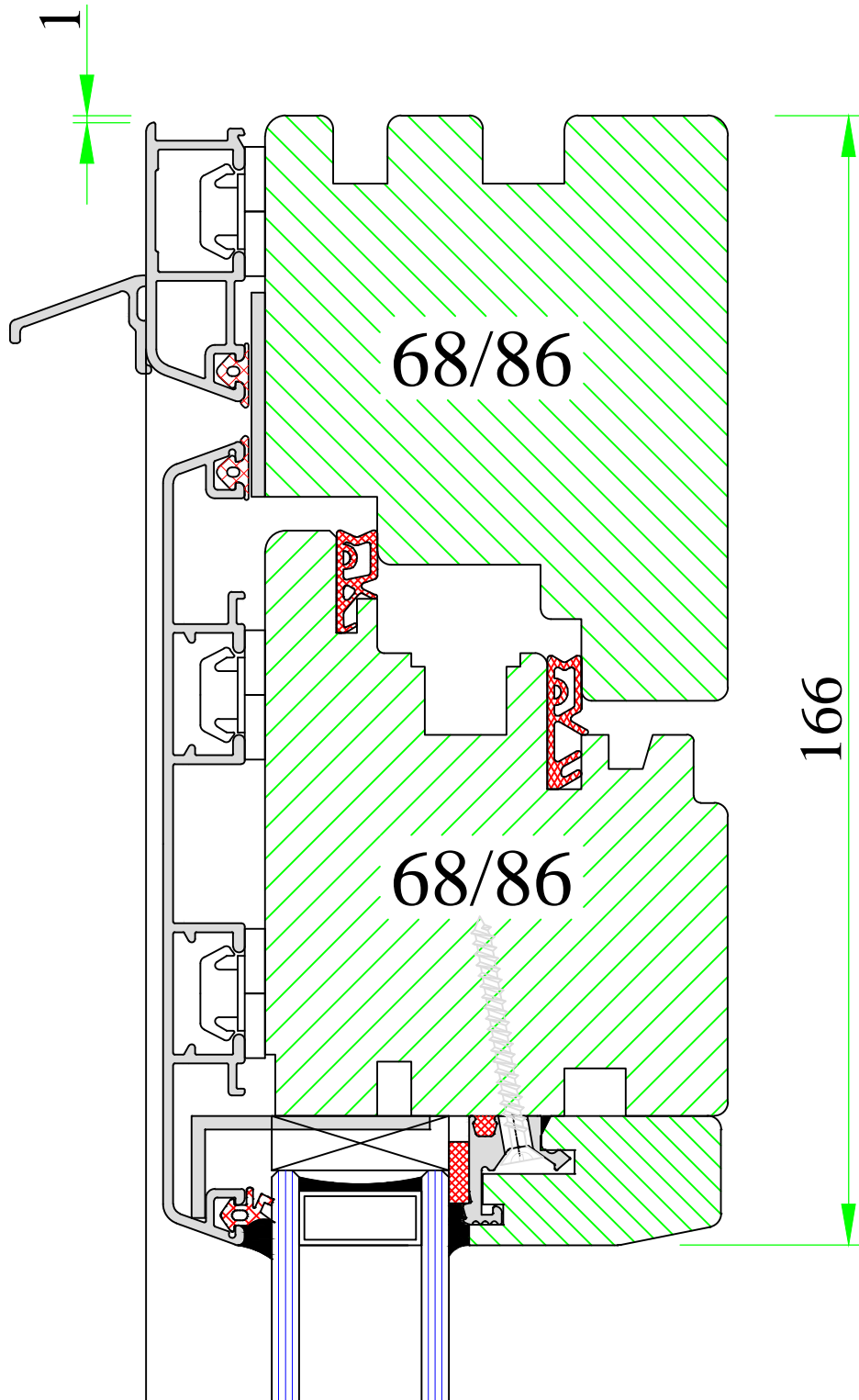
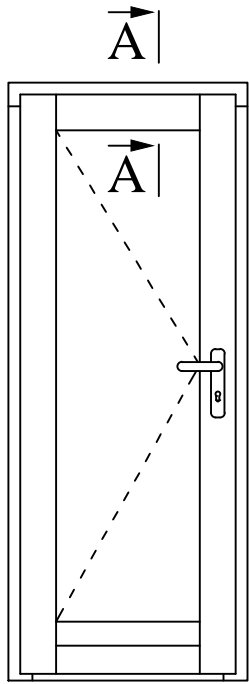

www.uniwin.co.uk



UNI WINDOWS Ltd.
 Unit 6, Edgefield Industrial Est.
 Loanhead, EH20 9TB
 Tel.: 0131 448 3931

MARCONI 1 / 2
 Outward opening door – top and sides

Version: 1	Scale: 1:1
Date: 15.05.14	Drawing: NM/22

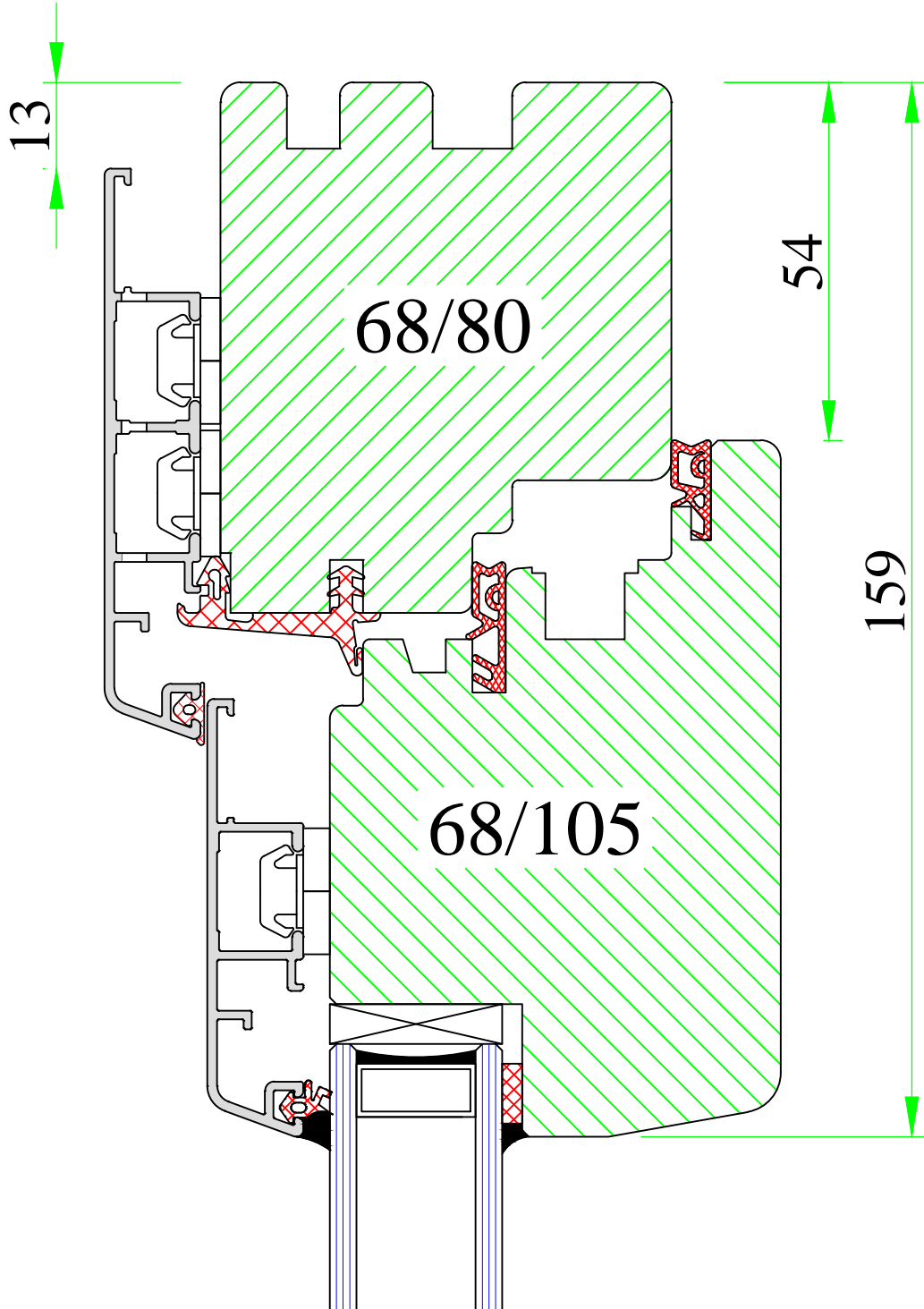
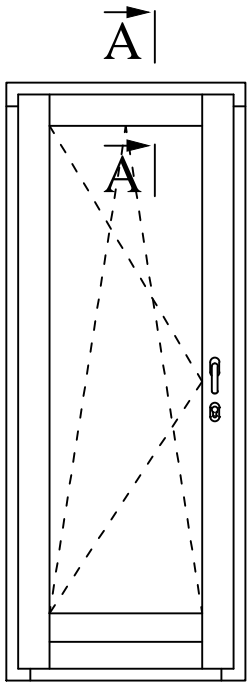

www.uniwin.co.uk



UNI WINDOWS Ltd.
 Unit 6, Edgefield Industrial Est.
 Loanhead, EH20 9TB
 Tel.: 0131 448 3931

MARCONI 1
 Frame-sash door connection – top and sides

Version: 1	Scale: 1:1
Date: 15.05.14	Drawing: NM/23

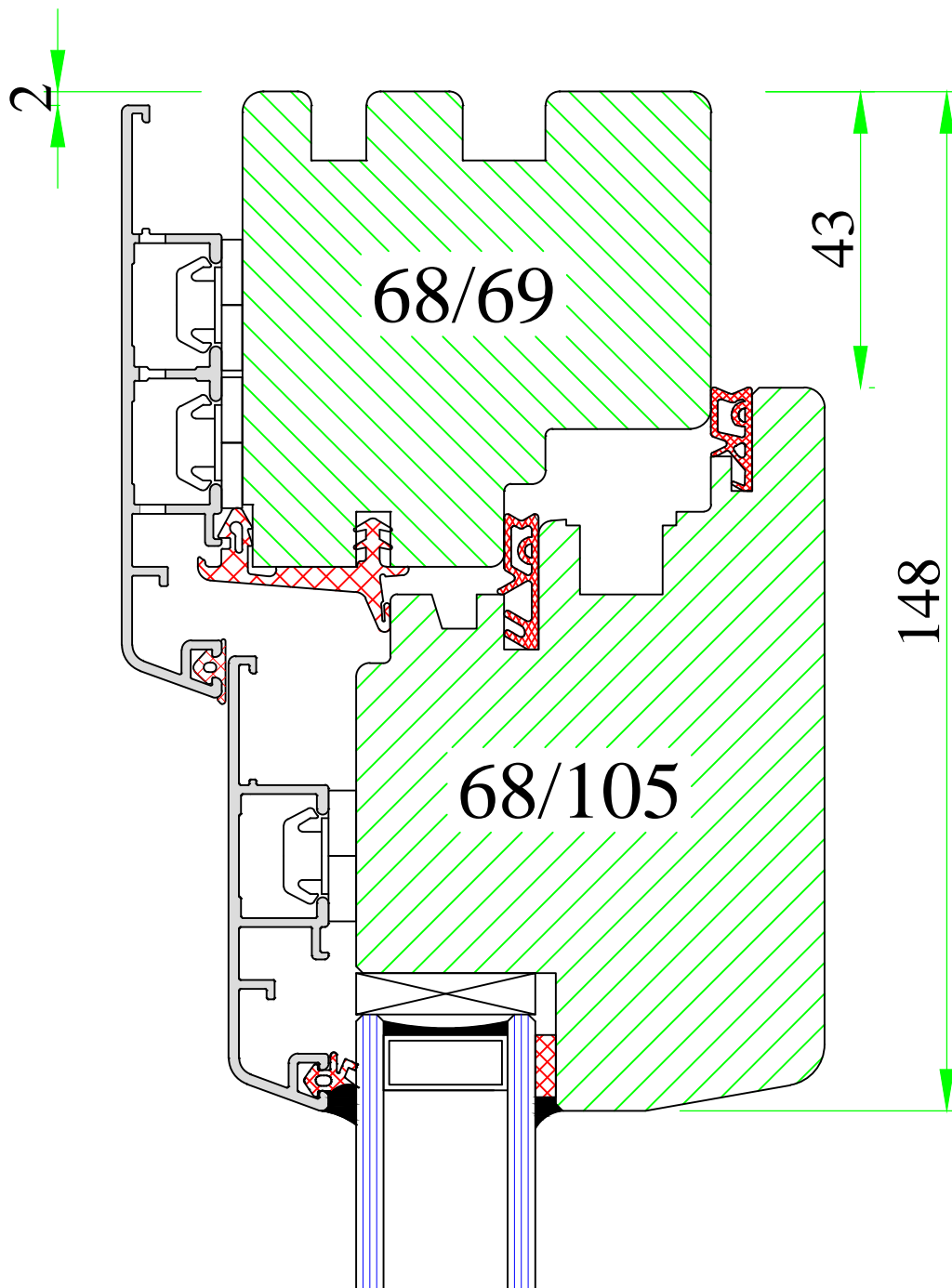
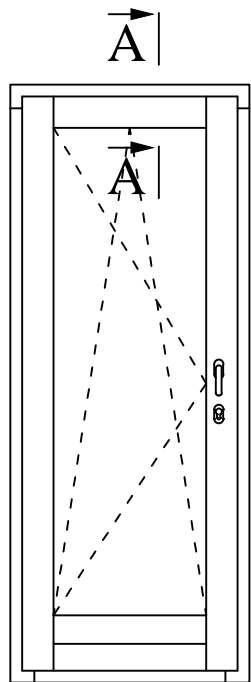

UNI WINDOWS Ltd.
 Unit 6, Edgefield Industrial Est.
 Loanhead, EH20 9TB
 Tel.: 0131 448 3931

MARCONI 2
 Frame-sash door connection – top and sides

Version: 1	Scale: 1:1
Date: 15.05.14	Drawing: NM2/23

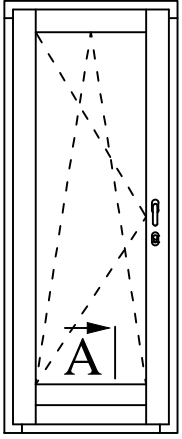

A

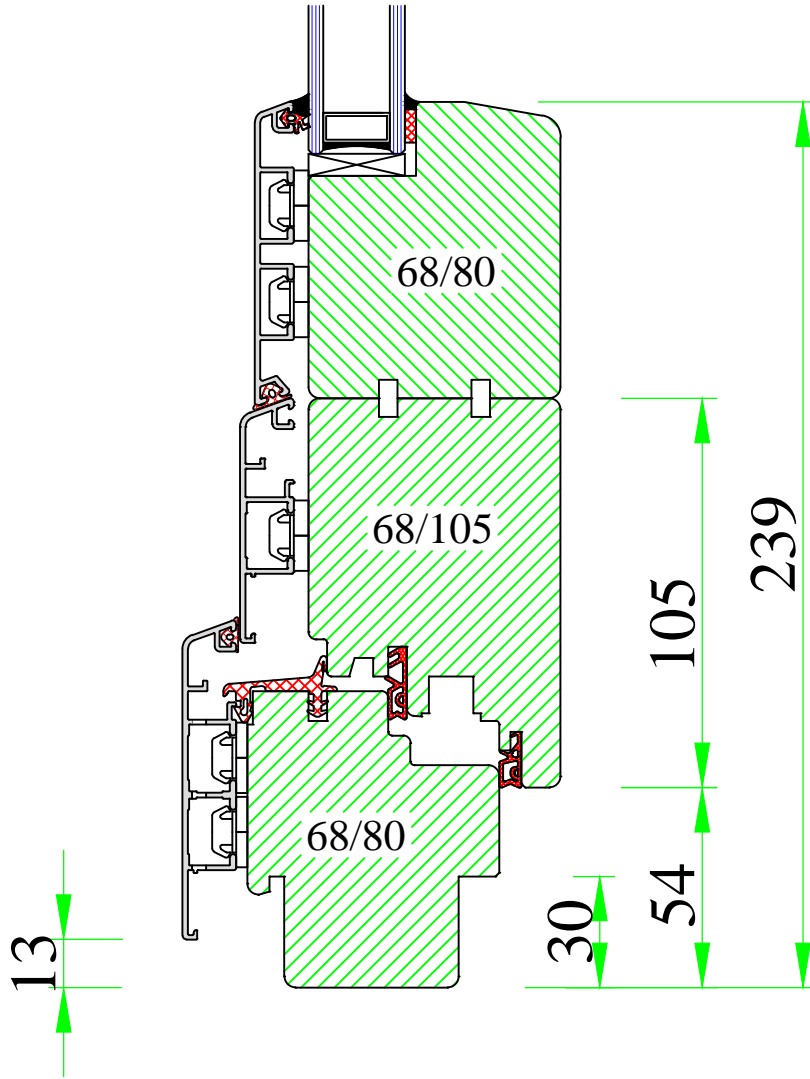

UNI WINDOWS Ltd.
 Unit 6, Edgefield Industrial Est.
 Loanhead, EH20 9TB
 Tel.: 0131 448 3931

MARCONI 1
 Frame-sash connection – bottom of balcony door

Version: 1	Scale: 1:2
Date: 15.05.14	Drawing: NM/24

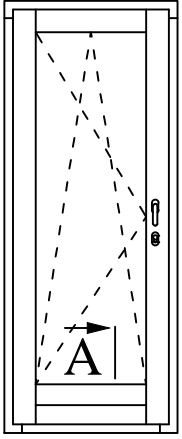

A

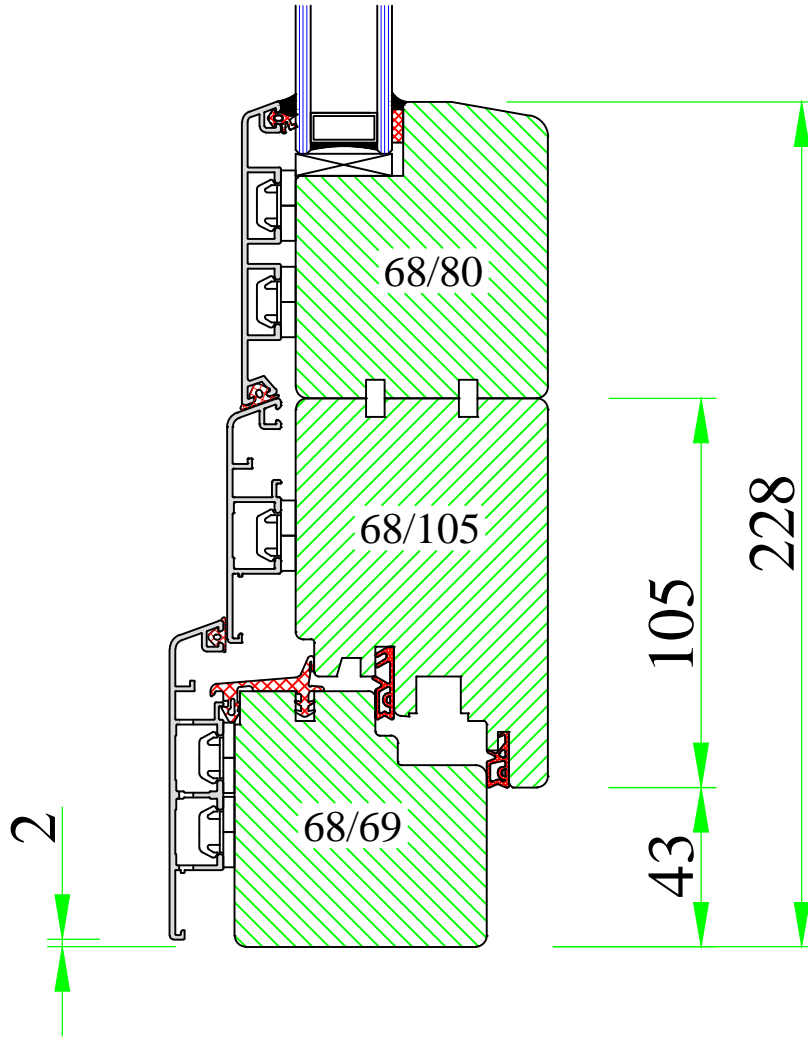

UNI WINDOWS Ltd.
 Unit 6, Edgefield Industrial Est.
 Loanhead, EH20 9TB
 Tel.: 0131 448 3931

MARCONI 2
 Frame-sash connection – bottom of balcony door

Version:
1
 Date:
15.05.14

Scale:
1:2
 Drawing:
NM2/24

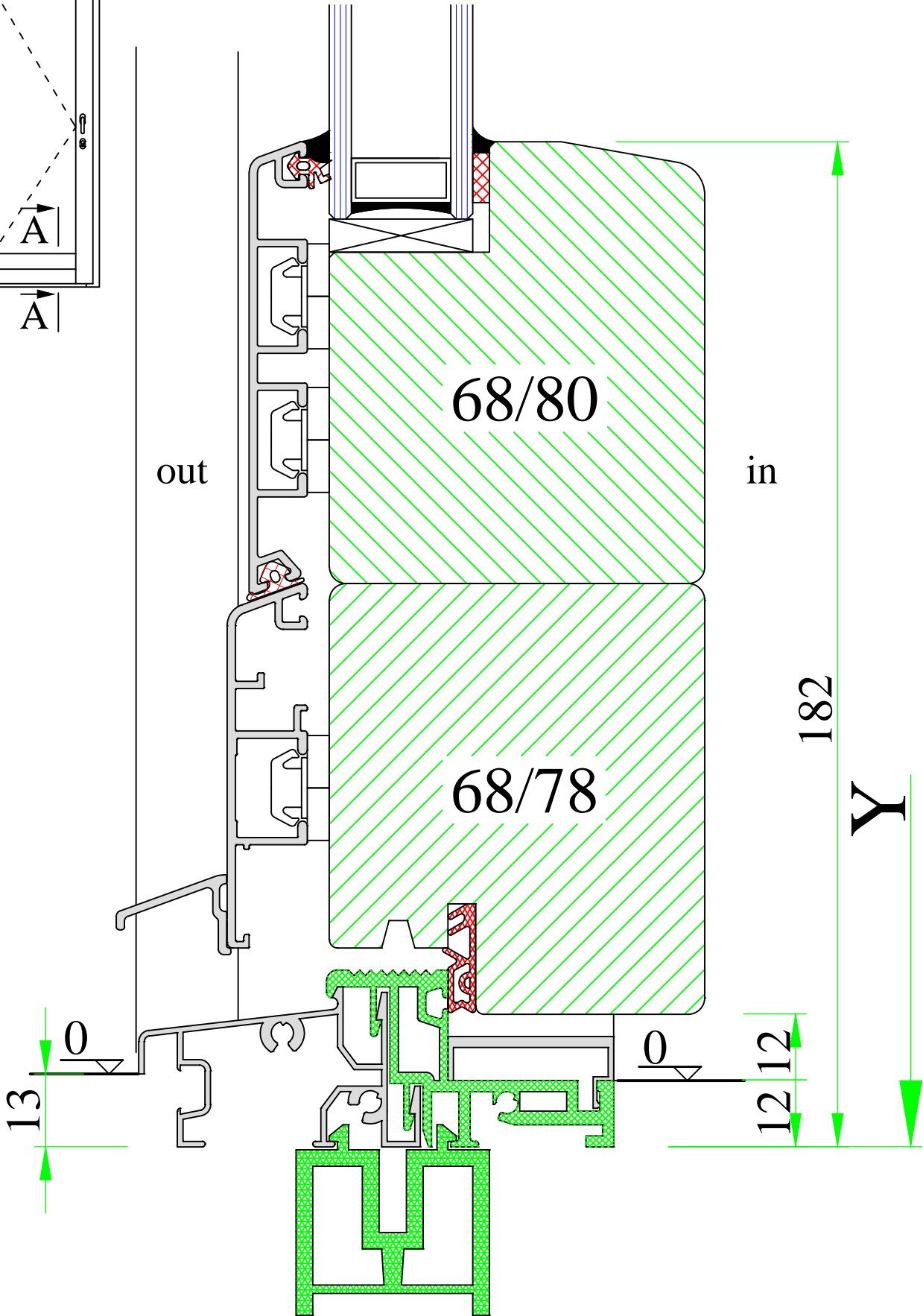
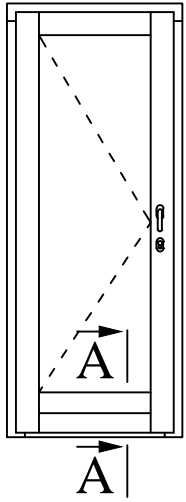

www.uniwin.co.uk



UNI WINDOWS Ltd.
 Unit 6, Edgefield Industrial Est.
 Loanhead, EH20 9TB
 Tel.: 0131 448 3931

MARCONI 1/2

Balcony door with flat Weser threshold (new)

Version:
1

Scale:
1:1

Date:
15.05.14

Drawing:
NM/25

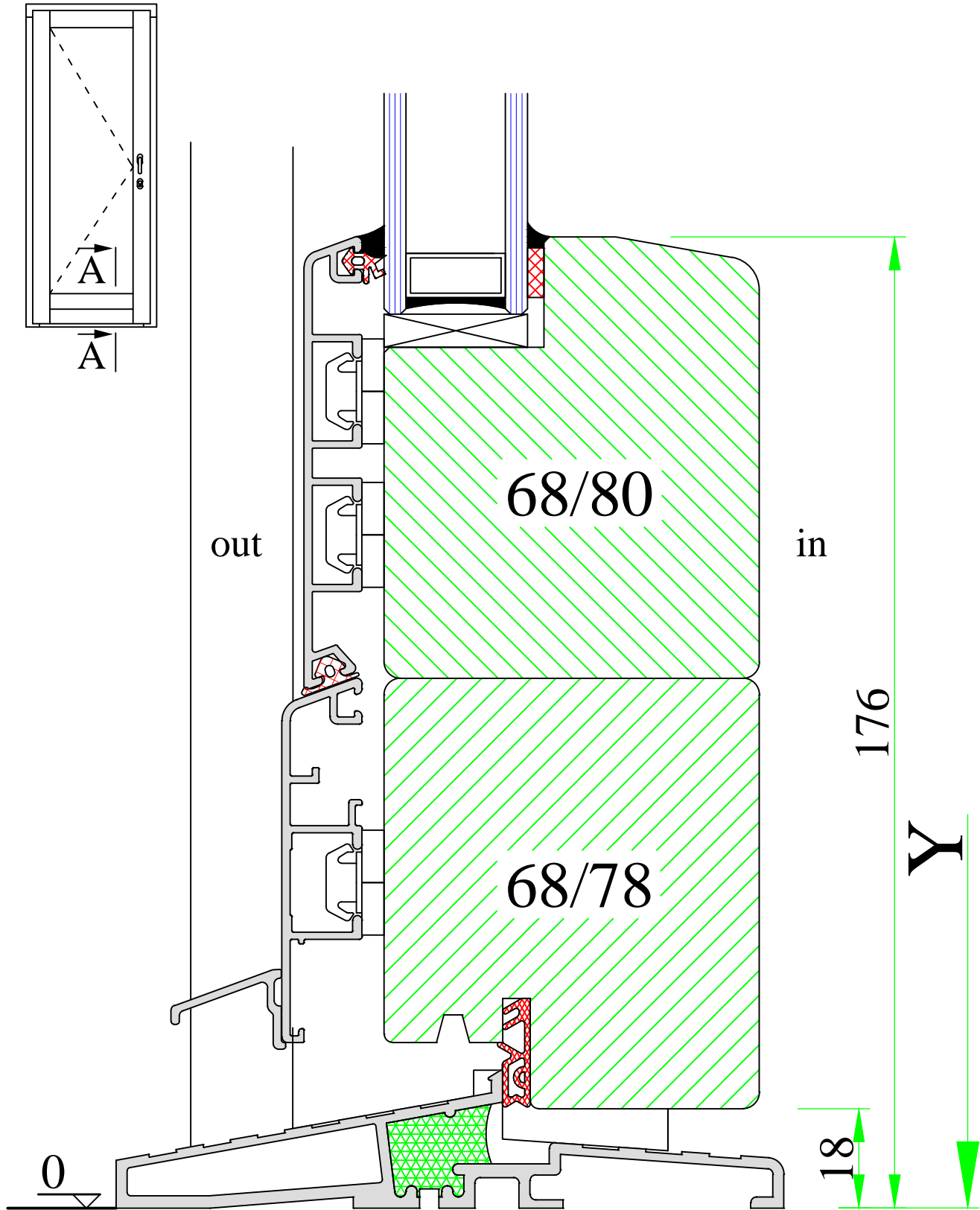

www.uniwin.co.uk



UNI WINDOWS Ltd.
 Unit 6, Edgefield Industrial Est.
 Loanhead, EH20 9TB
 Tel.: 0131 448 3931

MARCONI 1 / 2

Balcony door with flat Dafa threshold

Version:
1

Scale:
1:1

Date:
15.05.14

Drawing:
NM/26

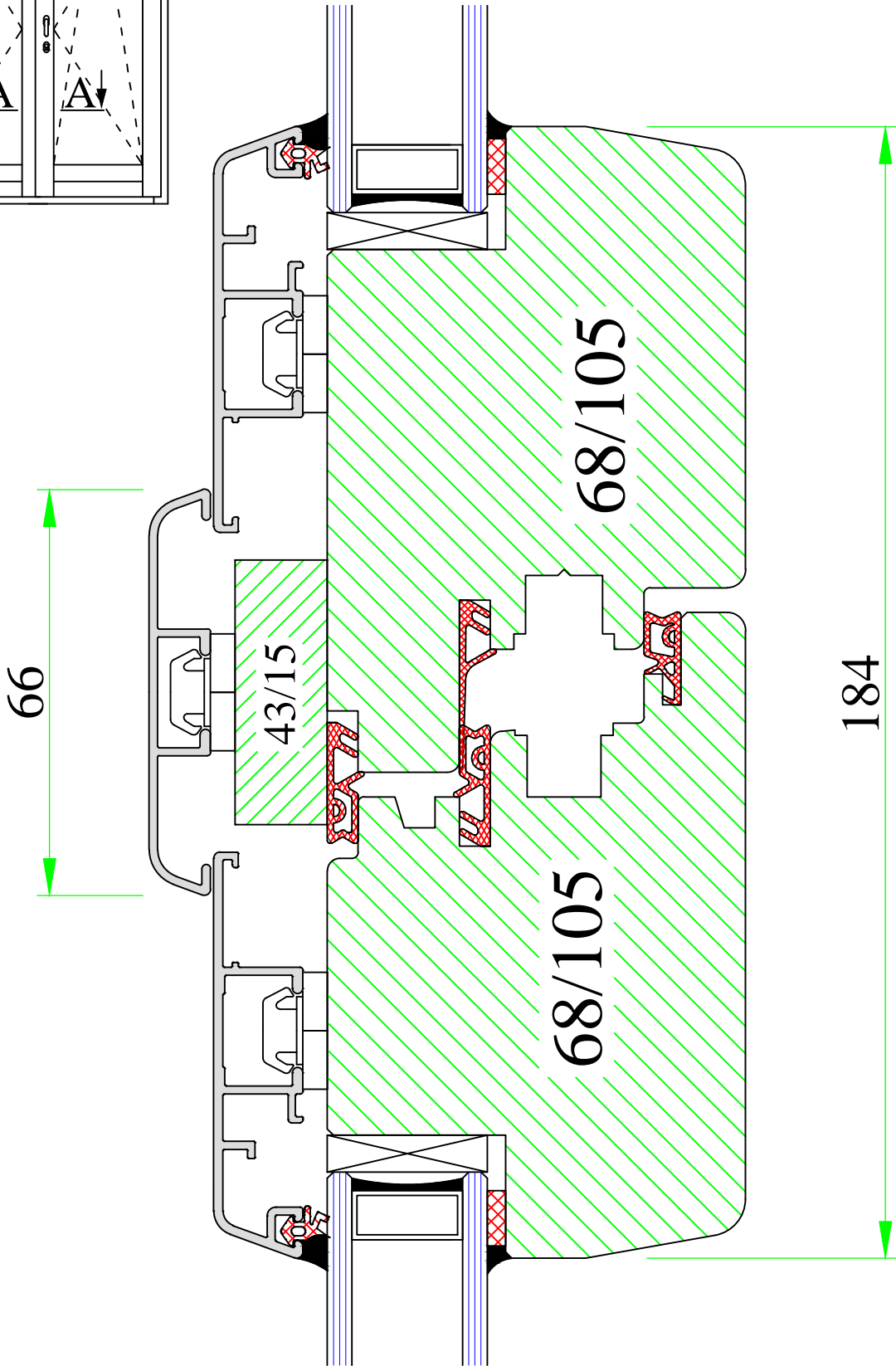
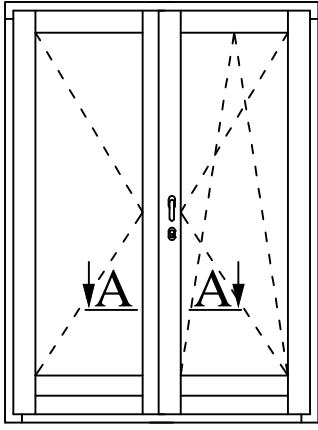

UNI WINDOWS Ltd.
 Unit 6, Edgefield Industrial Est.
 Loanhead, EH20 9TB
 Tel.: 0131 448 3931

MARCONI 1 / 2
 Balcony door - 'flying' mullion

Version: 1	Scale: 1:1
Date: 15.05.14	Drawing: NM/27

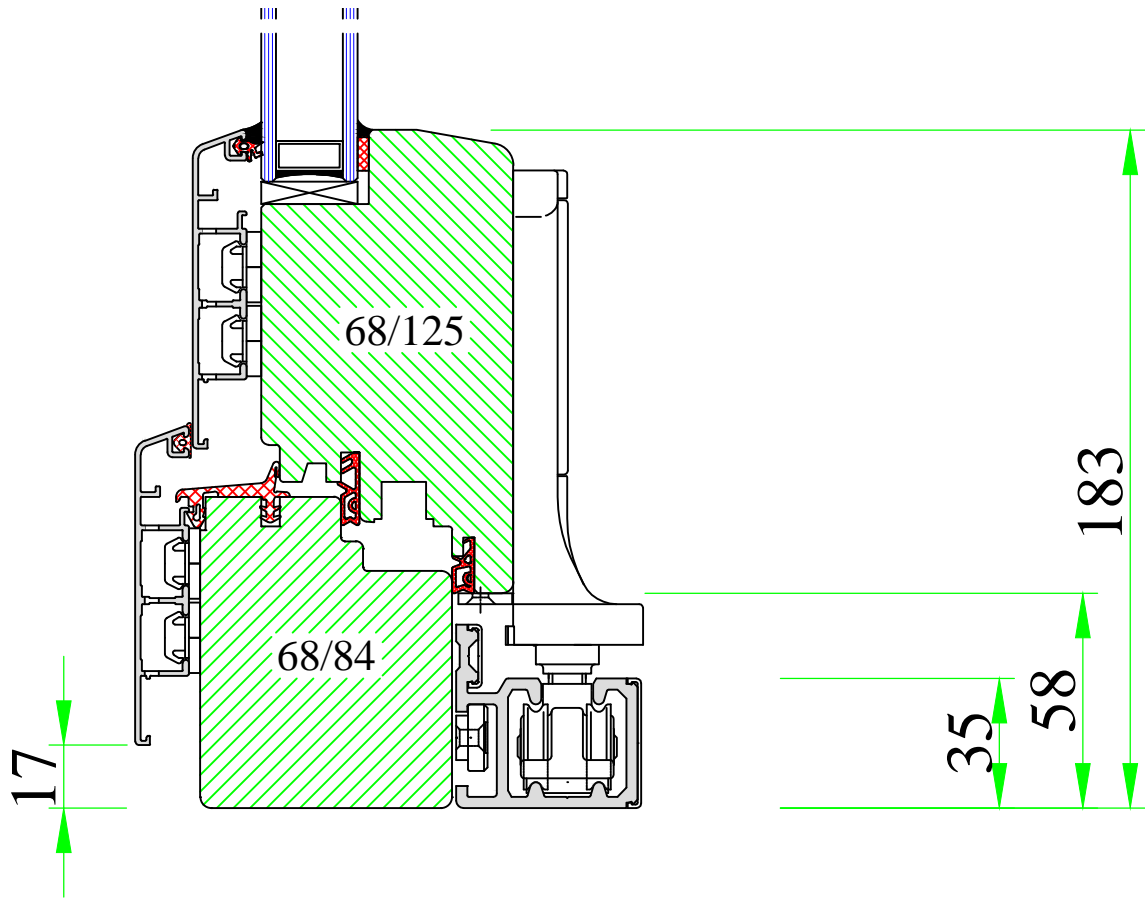
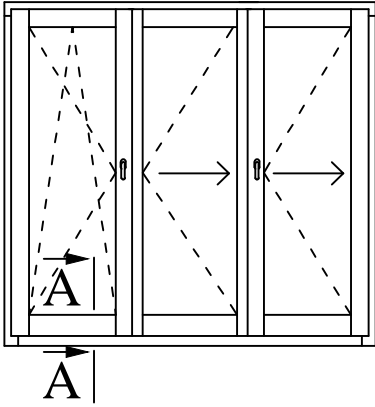

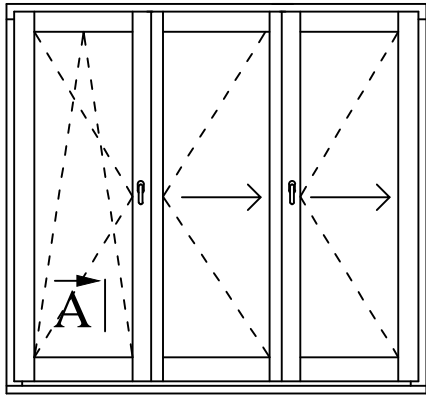

A

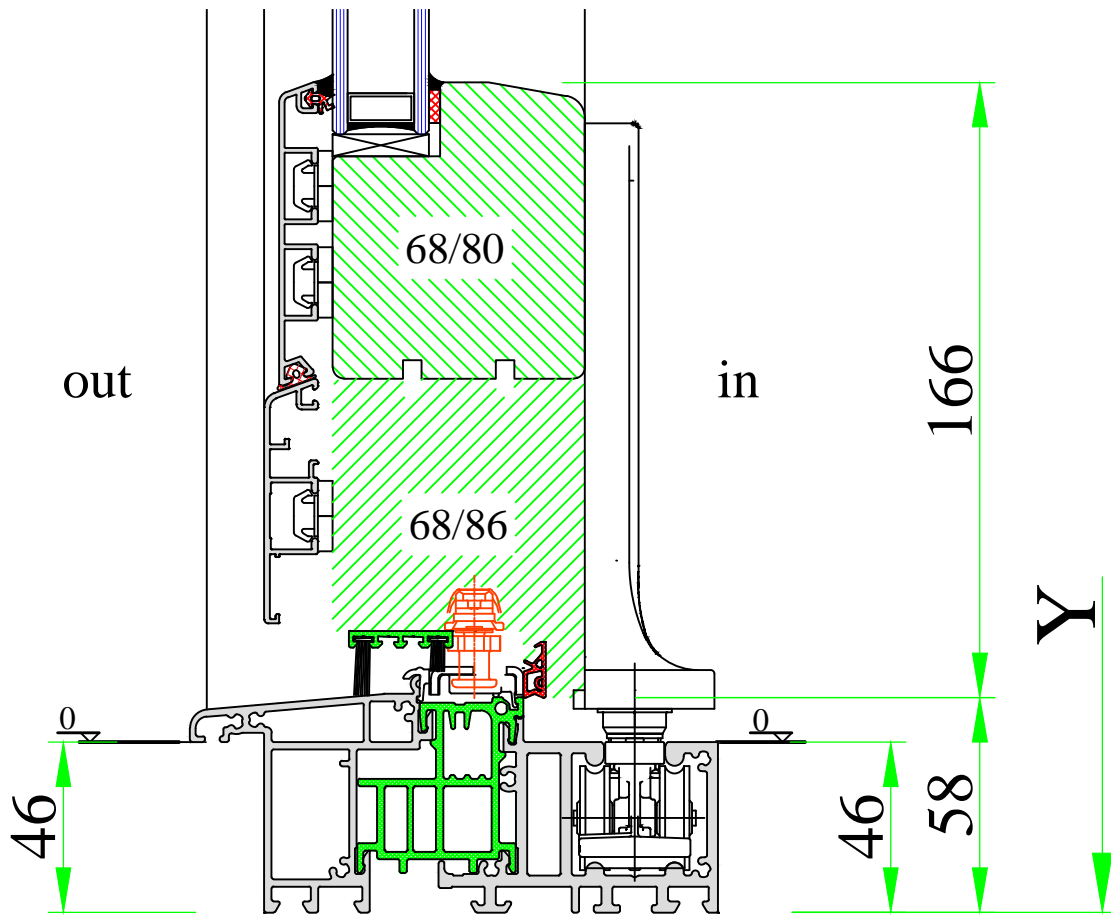

UNI WINDOWS Ltd.
 Unit 6, Edgefield Industrial Est.
 Loanhead, EH20 9TB
 Tel.: 0131 448 3931

MARCONI 1/ 2
 Folding sliding doors – flat threshold Comfort

Version:
 1
 Date:
 15.05.14

Scale:
 1:2
 Drawing:
 NM/29

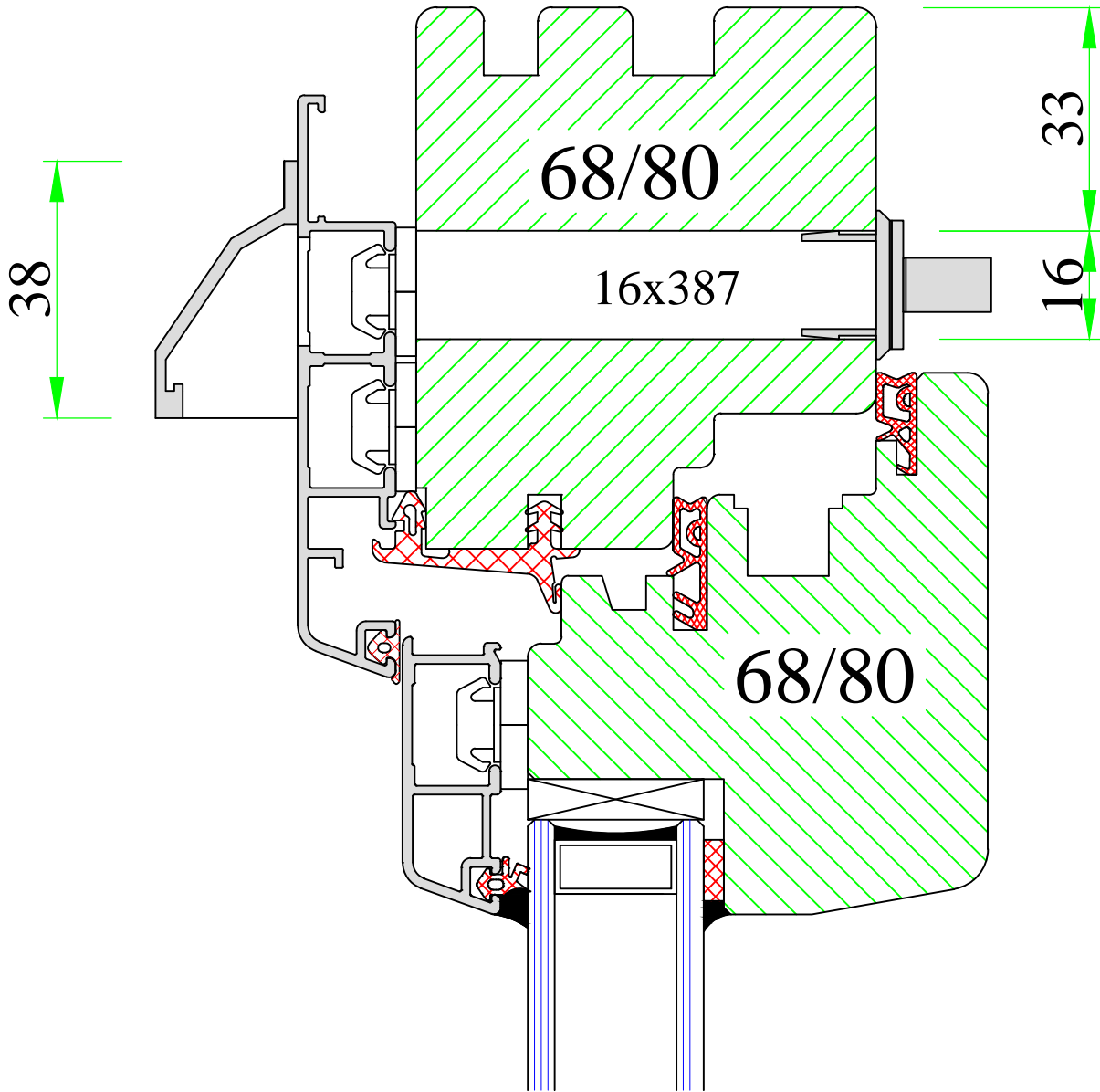
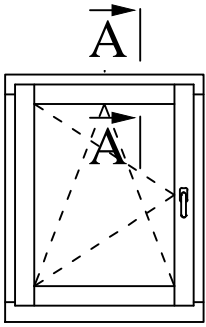

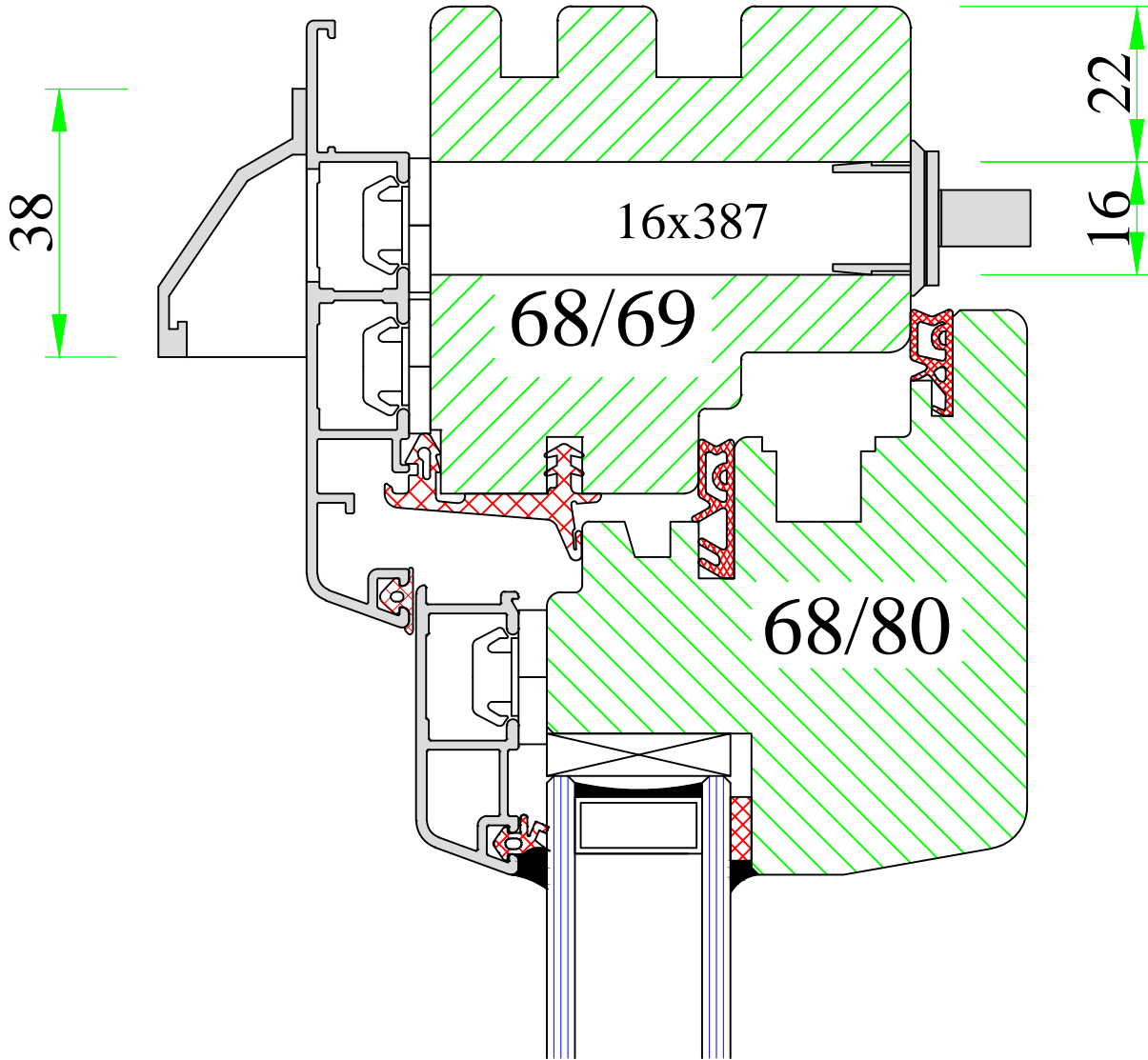
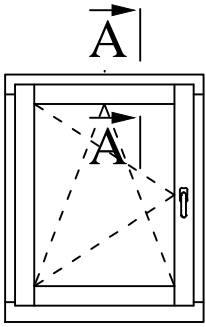

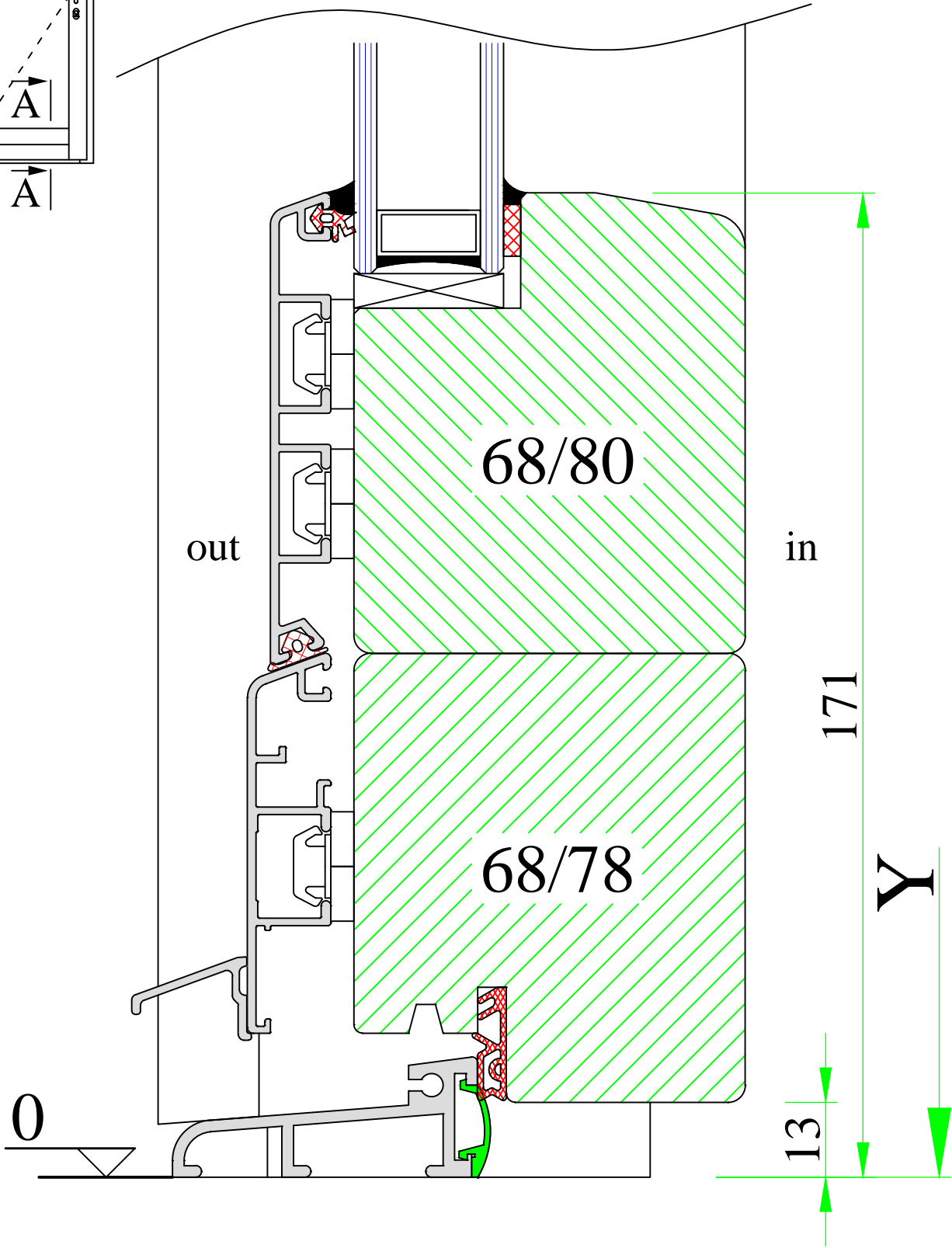
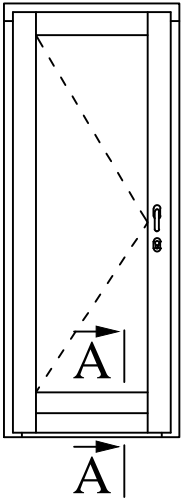

www.uniwin.co.uk



UNI WINDOWS Ltd.
 Unit 6, Edgefield Industrial Est.
 Loanhead, EH20 9TB
 Tel.: 0131 448 3931

MARCONI 1 / 2

Balcony door with Weser threshold (old)

Version:
1

Scale:
1:1

Date:
15.05.14

Drawing:
NM/31

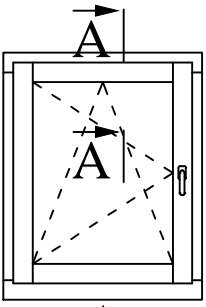

CLASSIC

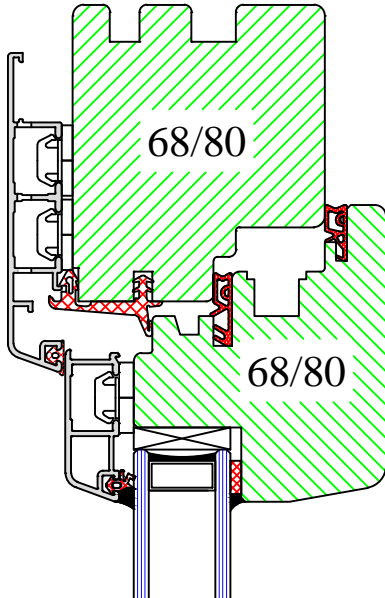

QUADRAT

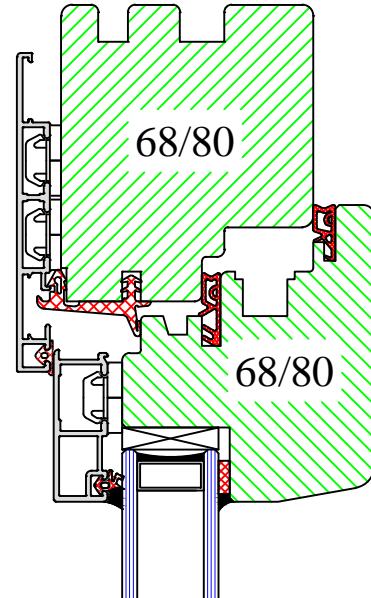

LINEAR

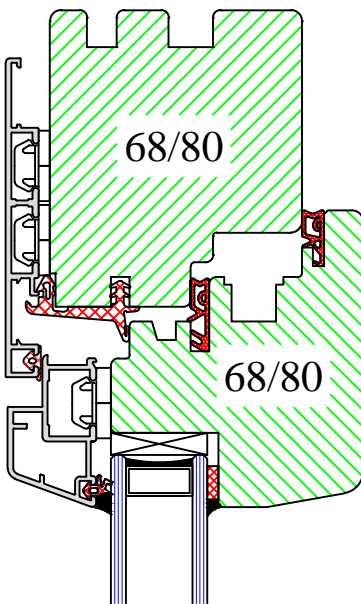

RETRO

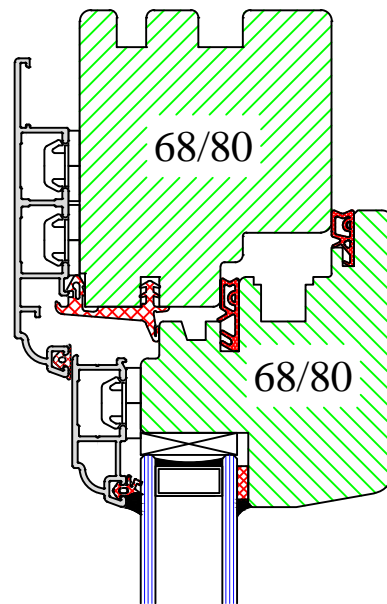

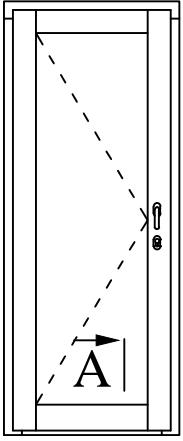

A

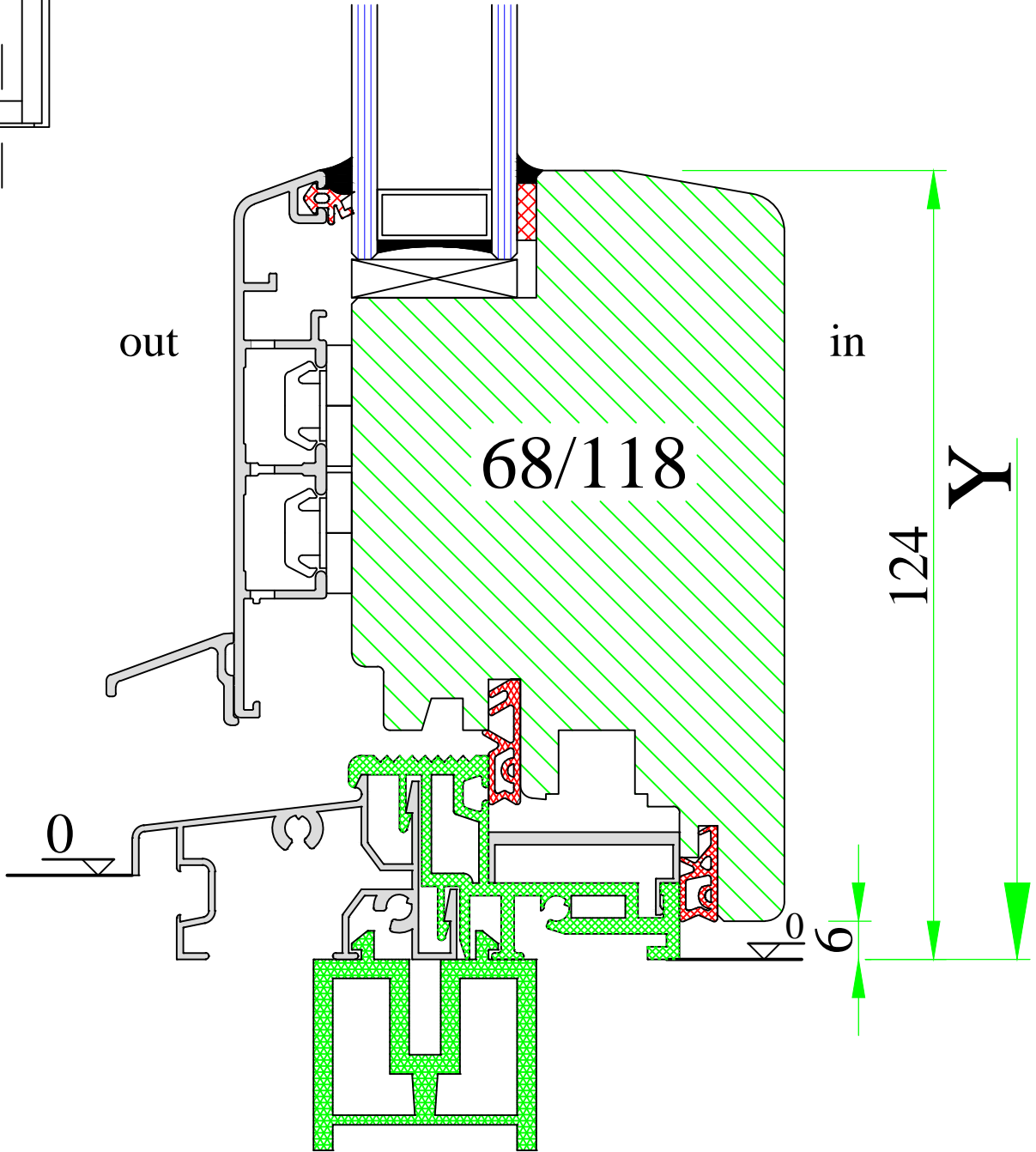

UNI WINDOWS Ltd.
 Unit 6, Edgefield Industrial Est.
 Loanhead, EH20 9TB
 Tel.: 0131 448 3931

MARCONI 1 / 2

Balcony door with Weser threshold

Version:
1

Scale:
1:1

Date:
15.05.14

Drawing:
NM/33

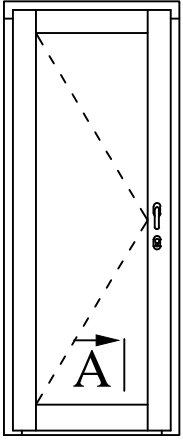

A

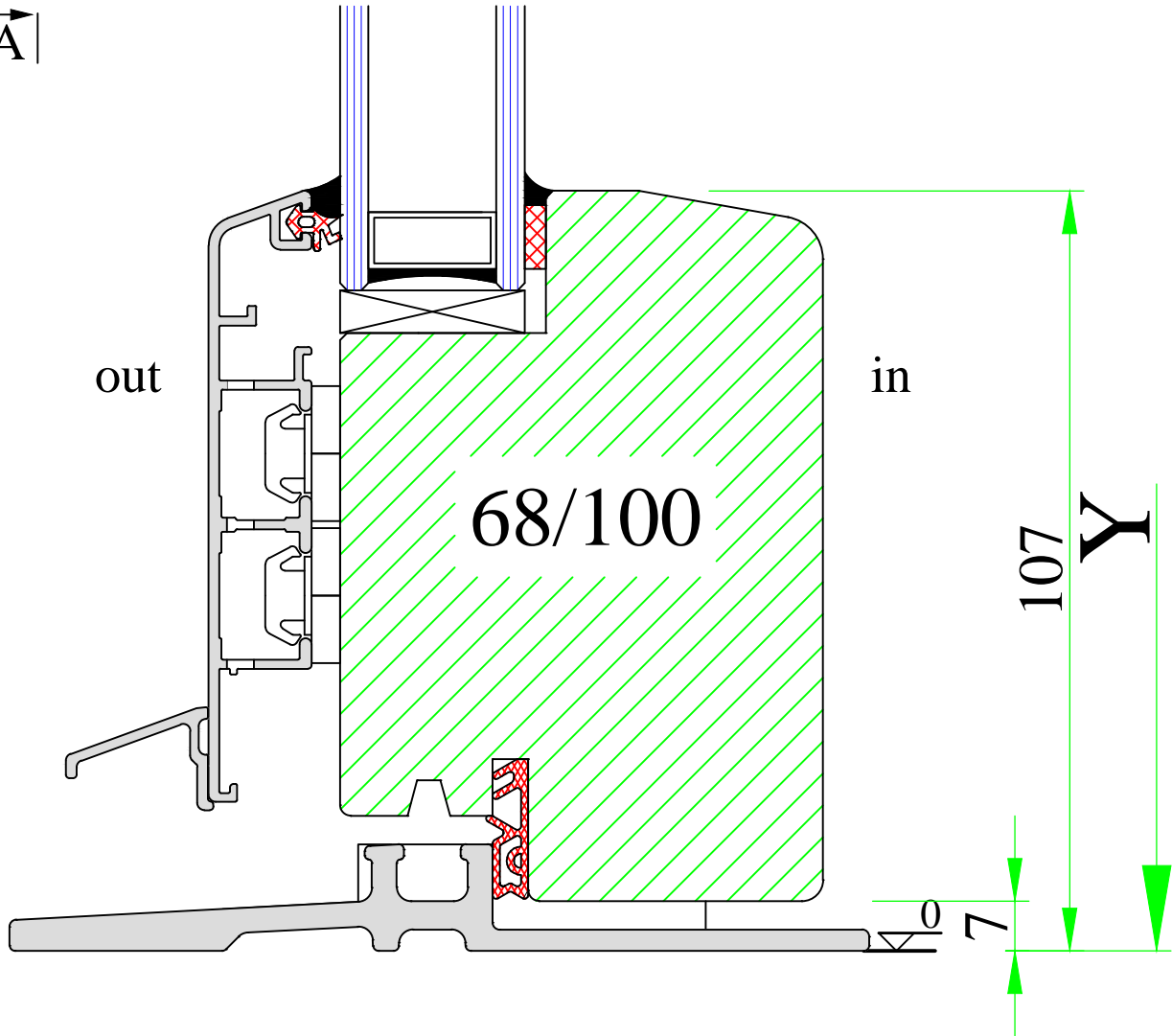

UNI WINDOWS Ltd.
 Unit 6, Edgefield Industrial Est.
 Loanhead, EH20 9TB
 Tel.: 0131 448 3931

MARCONI 1 / 2
 Balcony door with ULT threshold

Version: 1	Scale: 1:1
Date: 15.05.14	Drawing: NM/34