

A-A

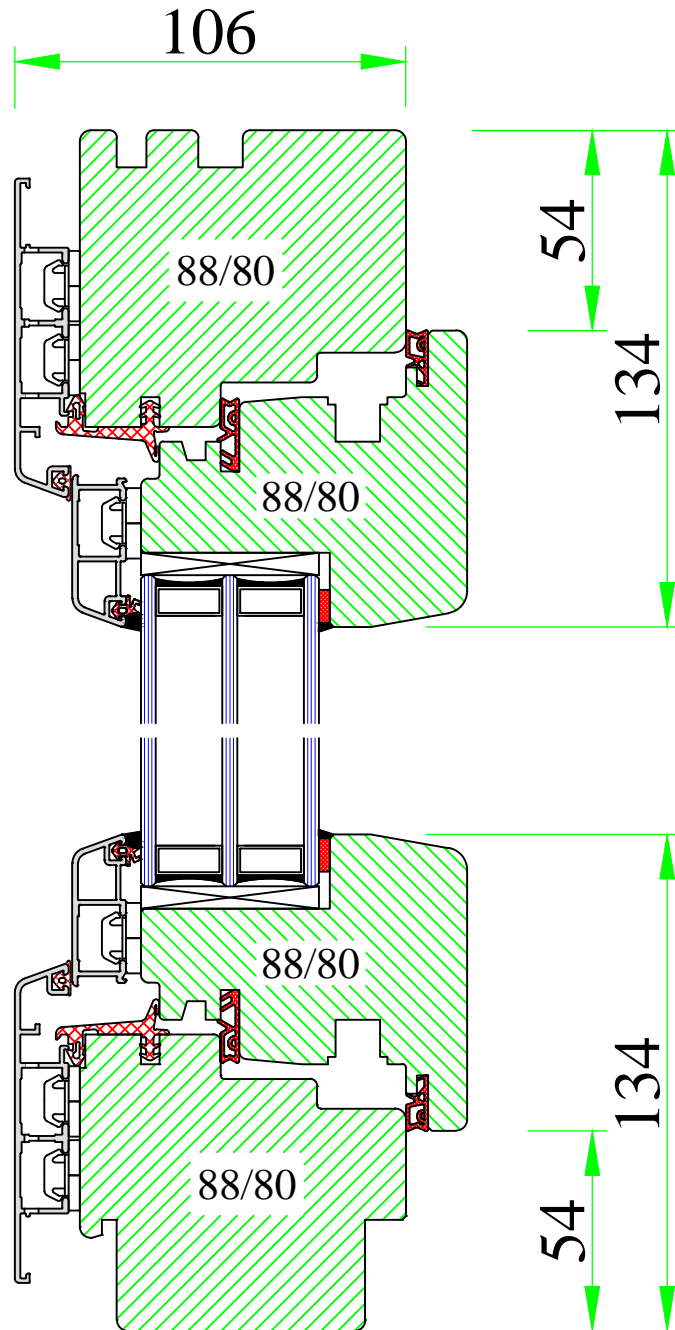

UNI WINDOWS Ltd.
 Unit 6, Edgefield Industrial Est.
 Loanhead, EH20 9TB
 Tel.: 0131 448 3931

Inward opening tilt and turn window

THERMAX

Version:
1

Scale:
1:2

Date:
15.05.14

Drawing:
NKK/1

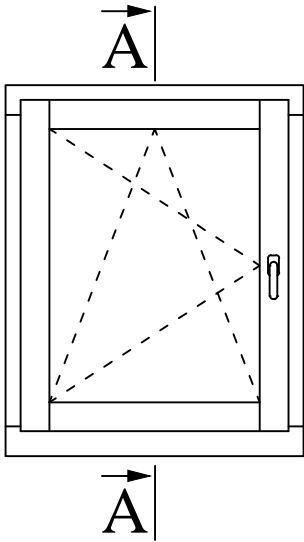

A-A

106

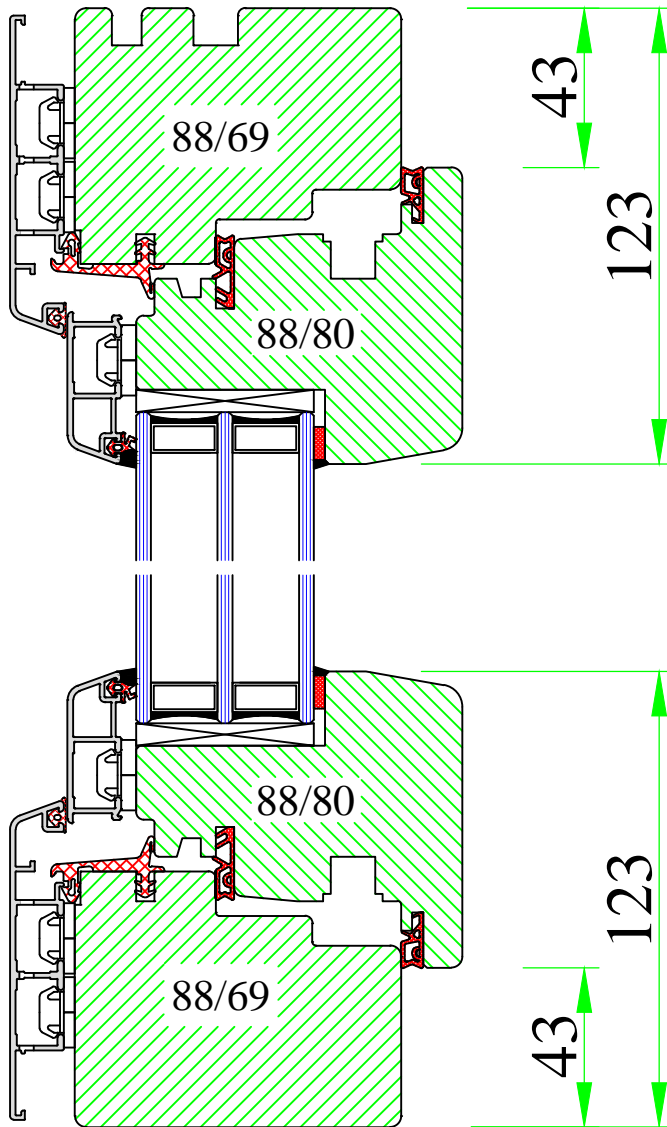

UNI WINDOWS Ltd.
 Unit 6, Edgefield Industrial Est.
 Loanhead, EH20 9TB
 Tel.: 0131 448 3931

THERMAX 2

Inward opening tilt and turn window

Version:
1

Date:
15.05.14

Scale:
1:2

Drawing:
NKK2/1

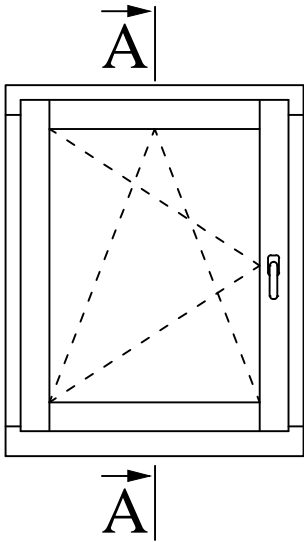

A-A

106

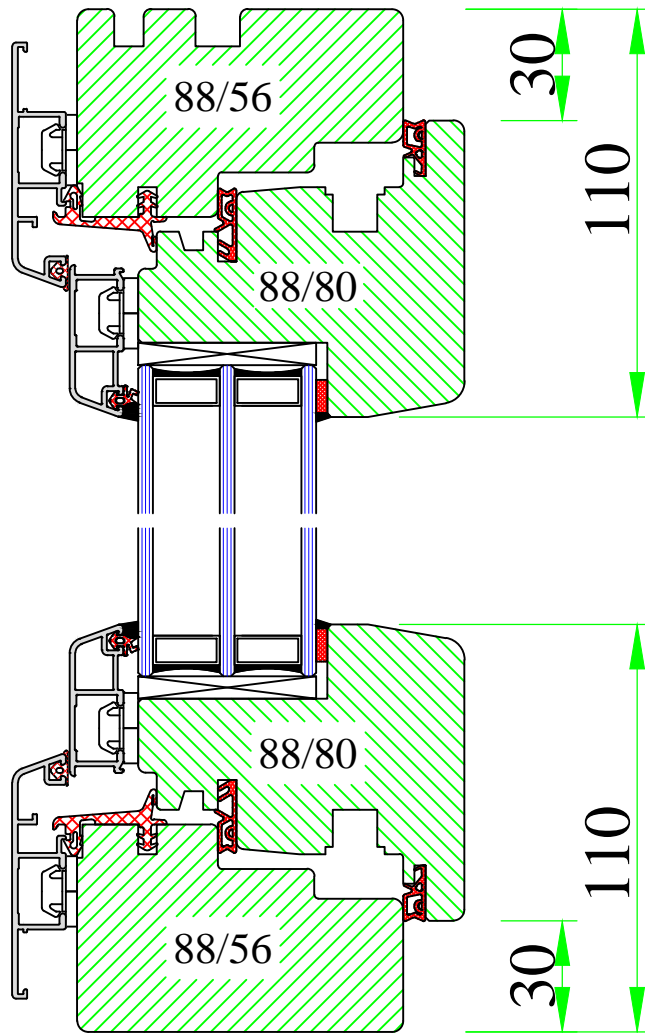

UNI WINDOWS Ltd.
 Unit 6, Edgefield Industrial Est.
 Loanhead, EH20 9TB
 Tel.: 0131 448 3931

Inward opening tilt and turn window

THERMAX 3

Version:
1

Scale:
1:2

Date:
15.05.14

Drawing:
NKK3/1

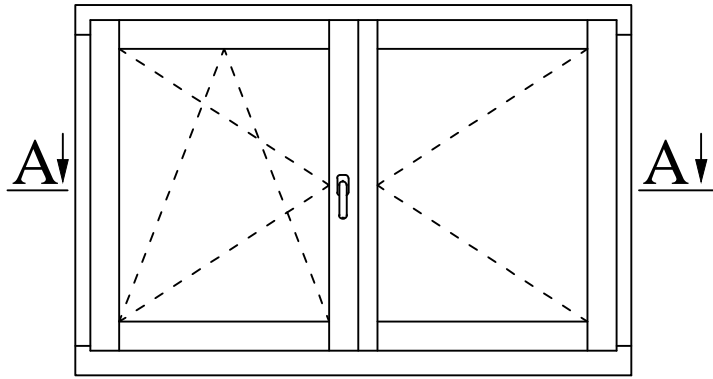

A-A

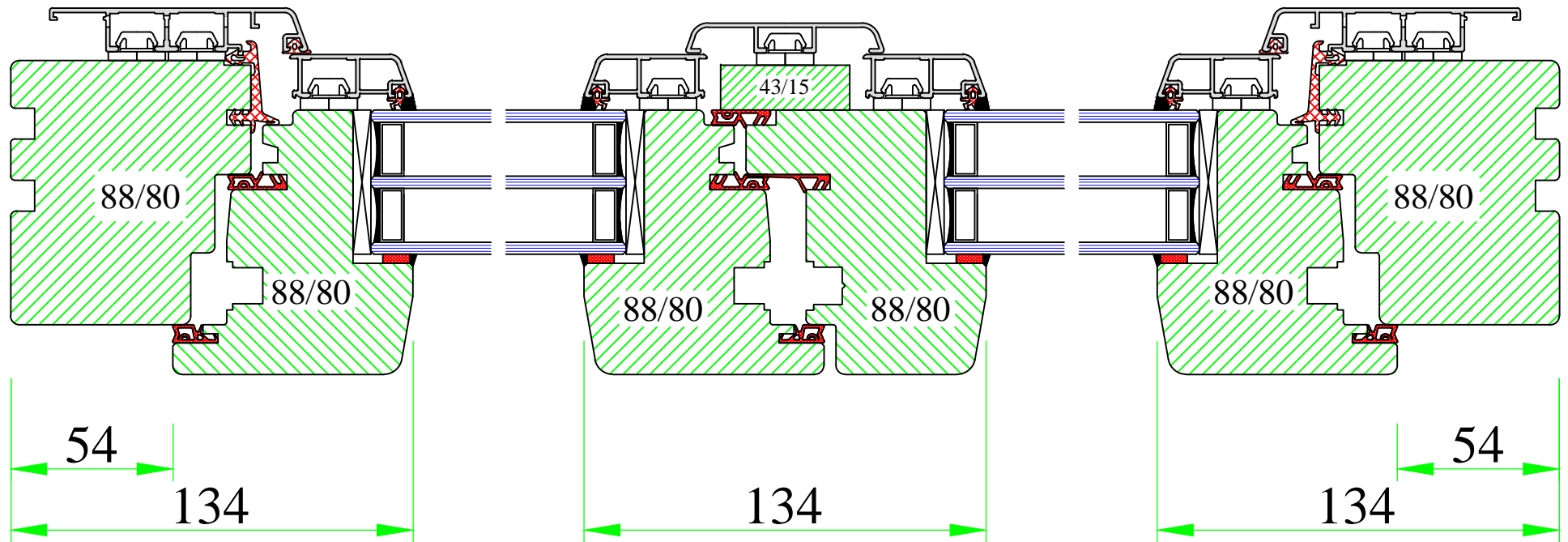

UNI WINDOWS Ltd.
 Unit 6, Edgefield Industrial Est.
 Loanhead, EH20 9TB
 Tel.: 0131 448 3931

THERMAX
 Double opening window 'flying' mullion

Version: 1	Scale: 1:2
Date: 15.05.14	Drawing: NKK/2

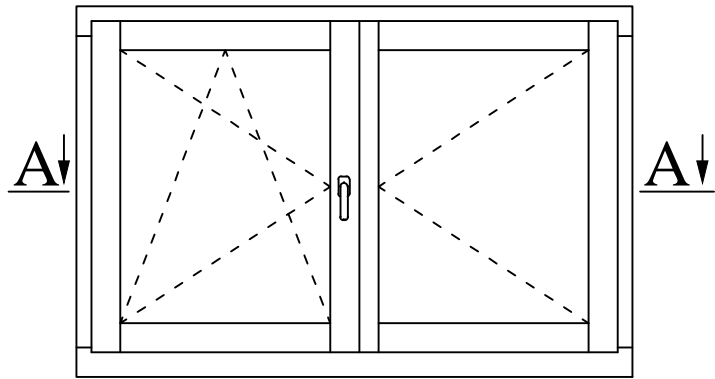

A-A

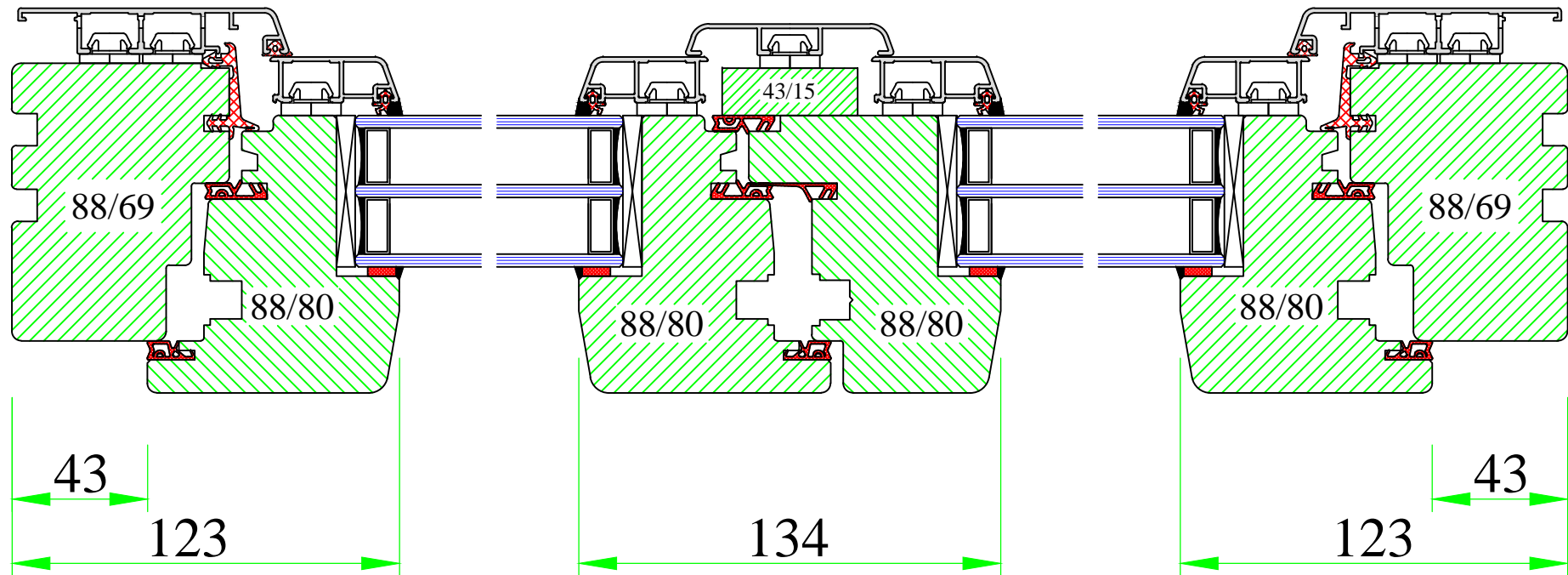

UNI WINDOWS Ltd.
 Unit 6, Edgefield Industrial Est.
 Loanhead, EH20 9TB
 Tel.: 0131 448 3931

THERMAX 2
 Double opening window 'flying' mullion

Version: 1	Scale: 1:2
Date: 15.05.14	Drawing: NKK2/2

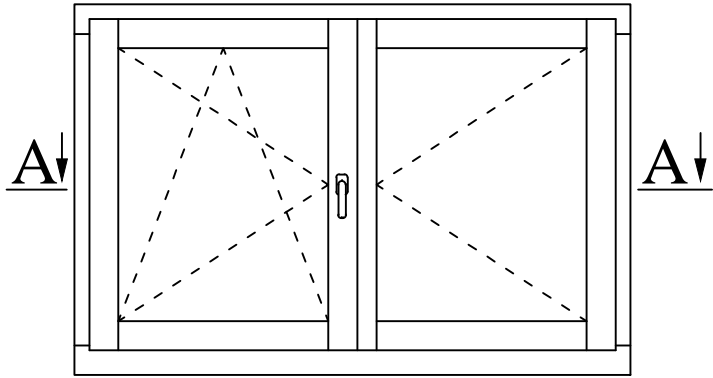

A-A

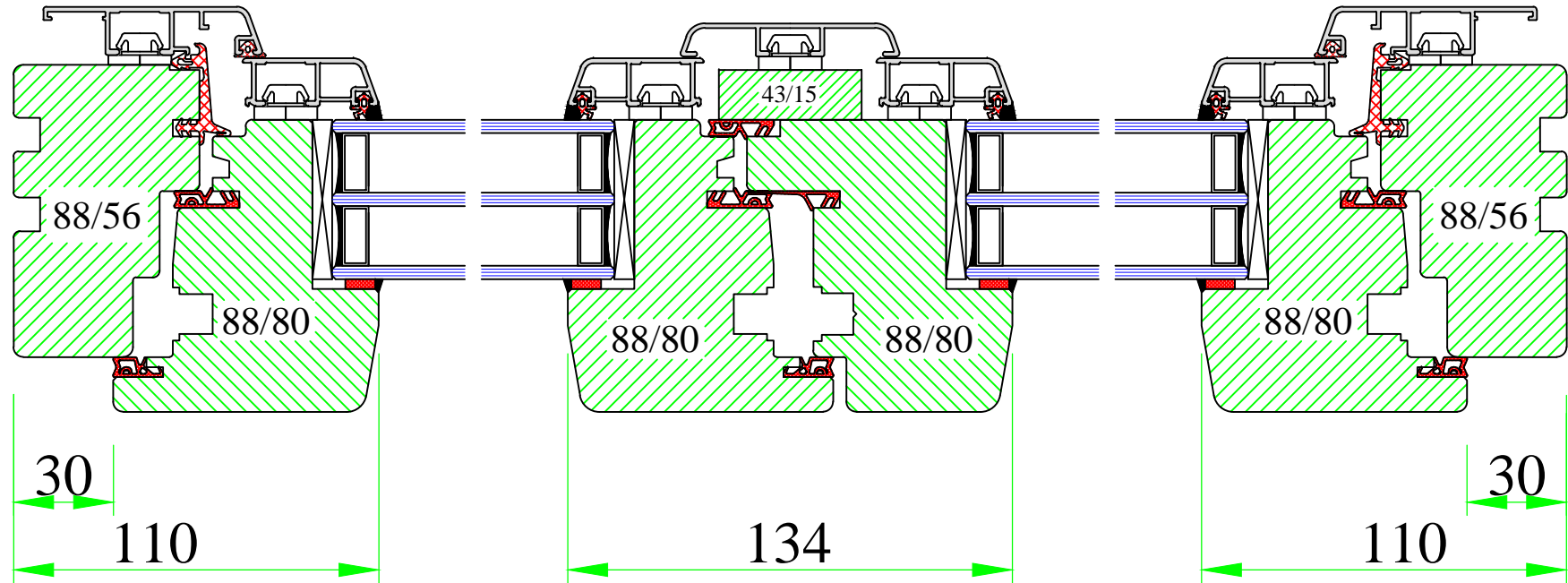

UNI WINDOWS Ltd.
 Unit 6, Edgefield Industrial Est.
 Loanhead, EH20 9TB
 Tel.: 0131 448 3931

THERMAX 3
 Double opening window 'flying' mullion

Version: 1	Scale: 1:2
Date: 15.05.14	Drawing: NKK3/2

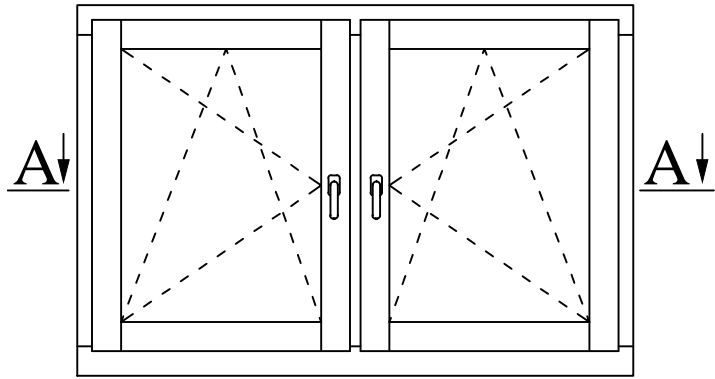

A-A

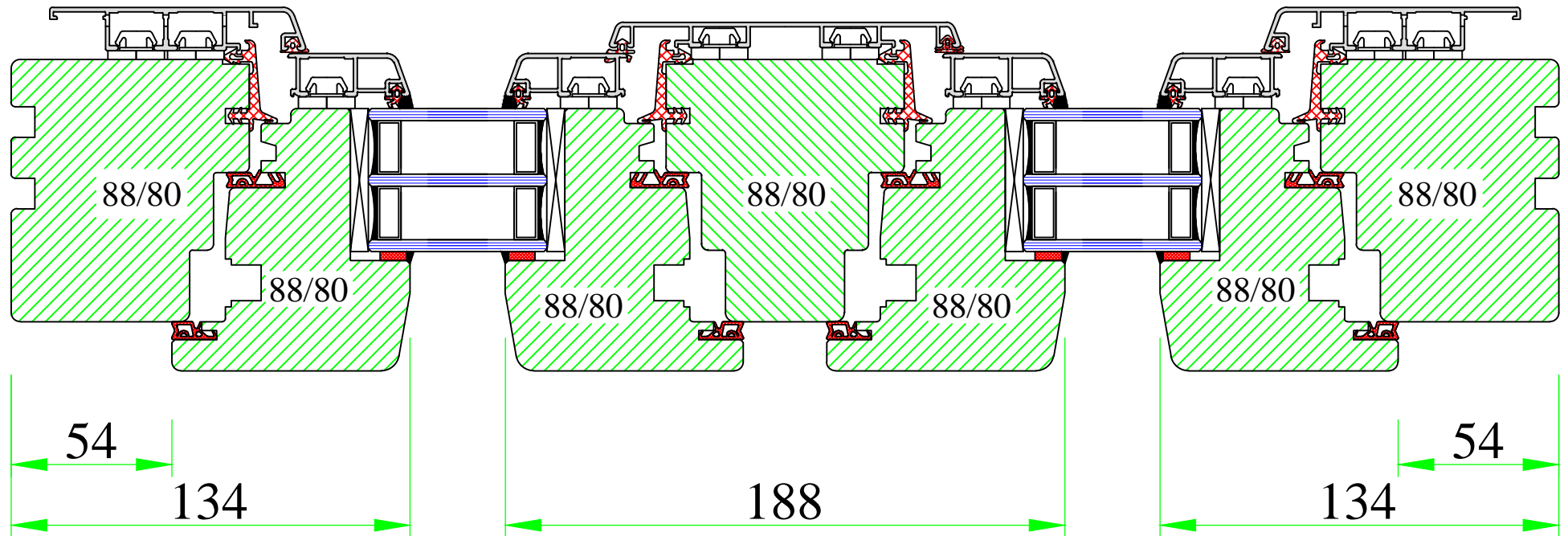

www.uniwin.co.uk



UNI WINDOWS Ltd.
 Unit 6, Edgefield Industrial Est.
 Loanhead, EH20 9TB
 Tel.: 0131 448 3931

THERMAX
 Double opening window with fixed post 80mm

Version: 1	Scale: 1:2
Date: 15.05.14	Drawing: NKK/3

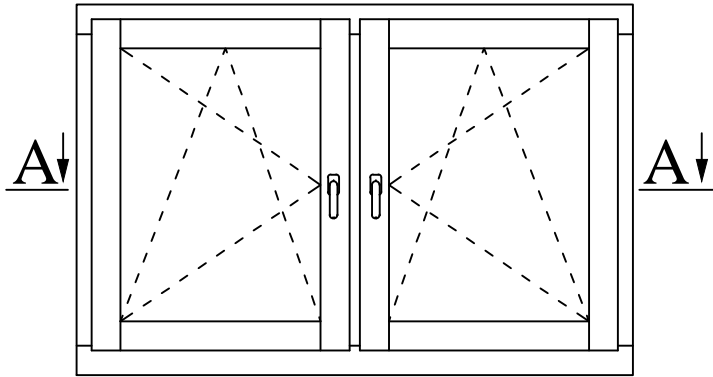

A-A

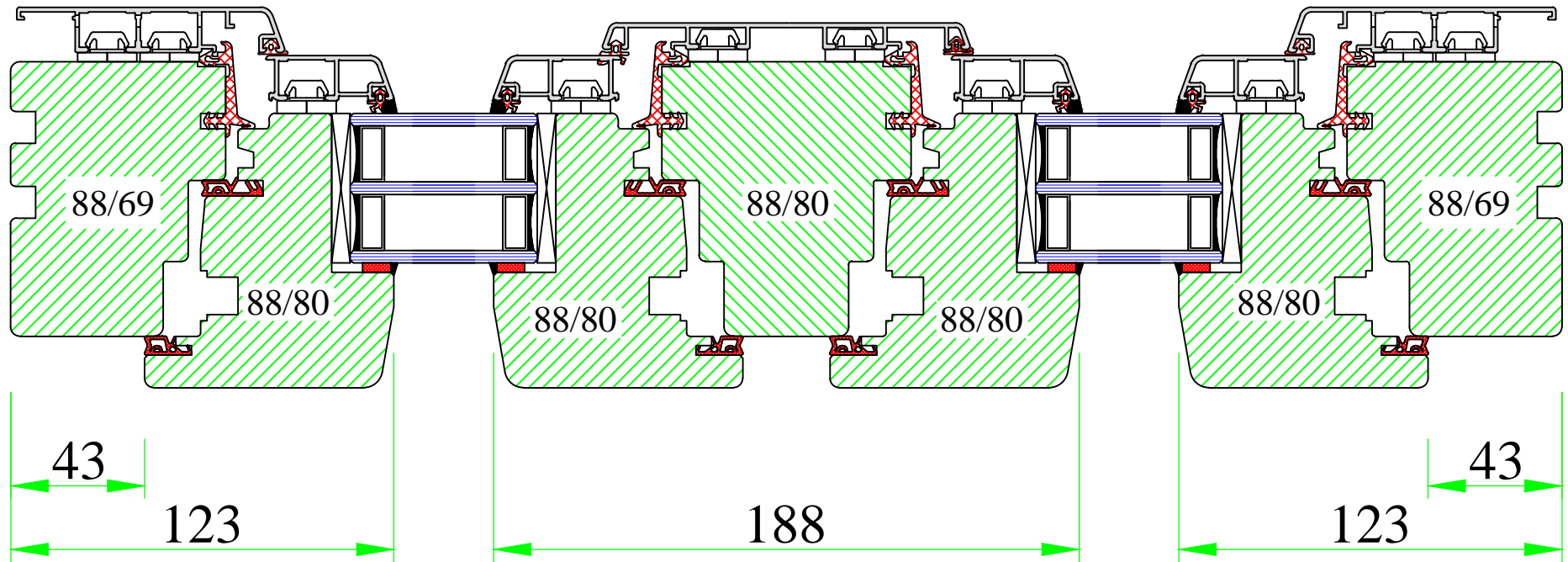

UNI WINDOWS Ltd.
 Unit 6, Edgefield Industrial Est.
 Loanhead, EH20 9TB
 Tel.: 0131 448 3931

THERMAX 2
 Double opening window with fixed post 80mm

Version: 1	Scale: 1:2
Date: 15.05.14	Drawing: NKK2/3

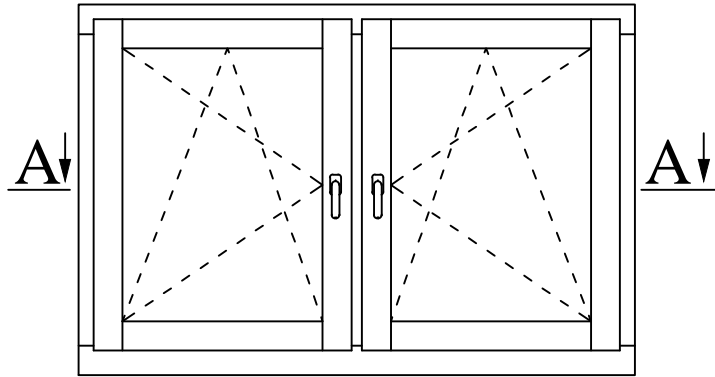

A-A

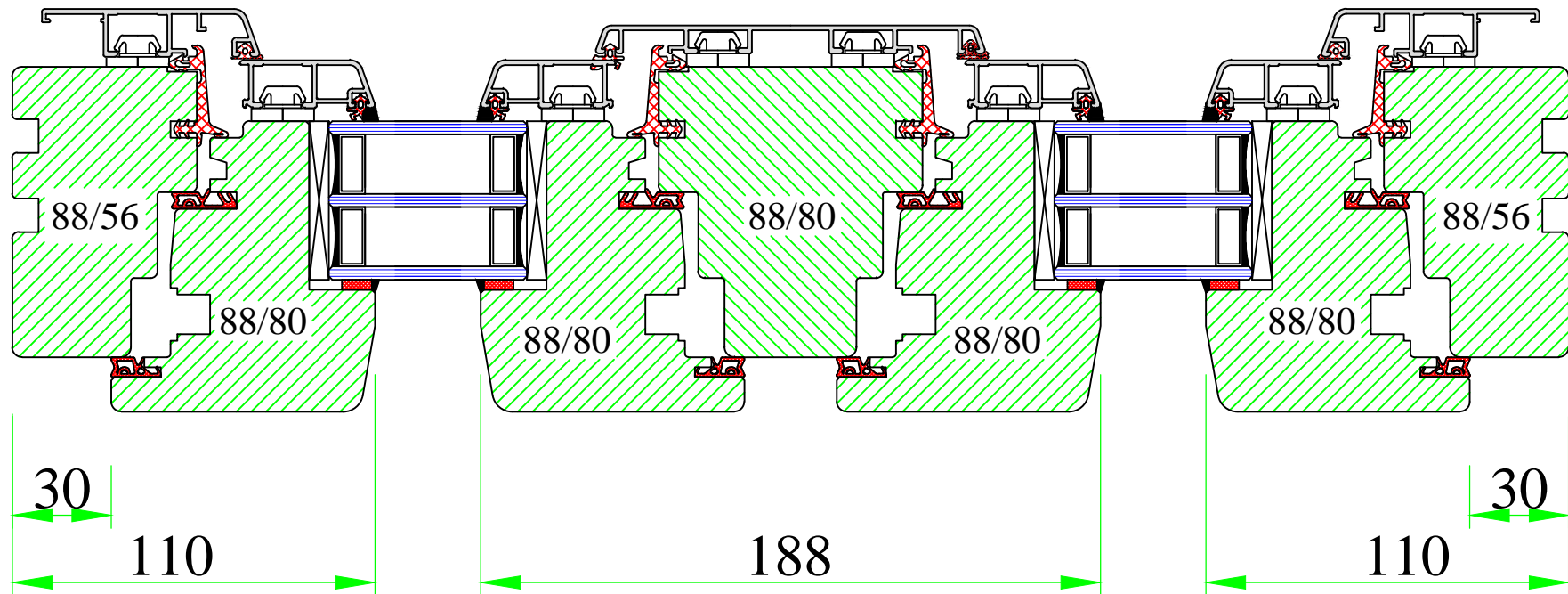

UNI WINDOWS Ltd.
 Unit 6, Edgefield Industrial Est.
 Loanhead, EH20 9TB
 Tel.: 0131 448 3931

THERMAX 3
 Double opening window with fixed post 80mm

Version: 1	Scale: 1:2
Date: 15.05.14	Drawing: NKK3/3

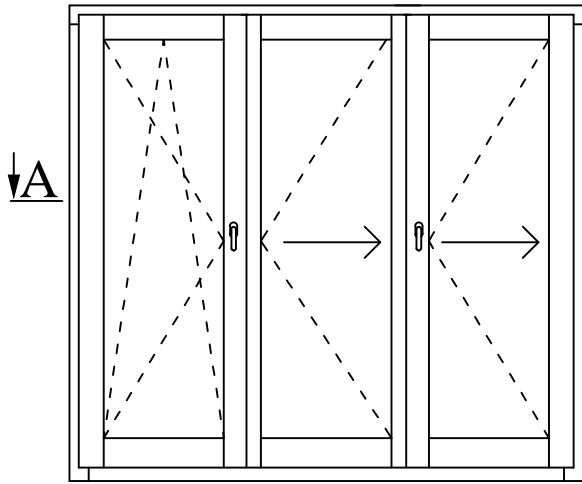

A↓

A-A

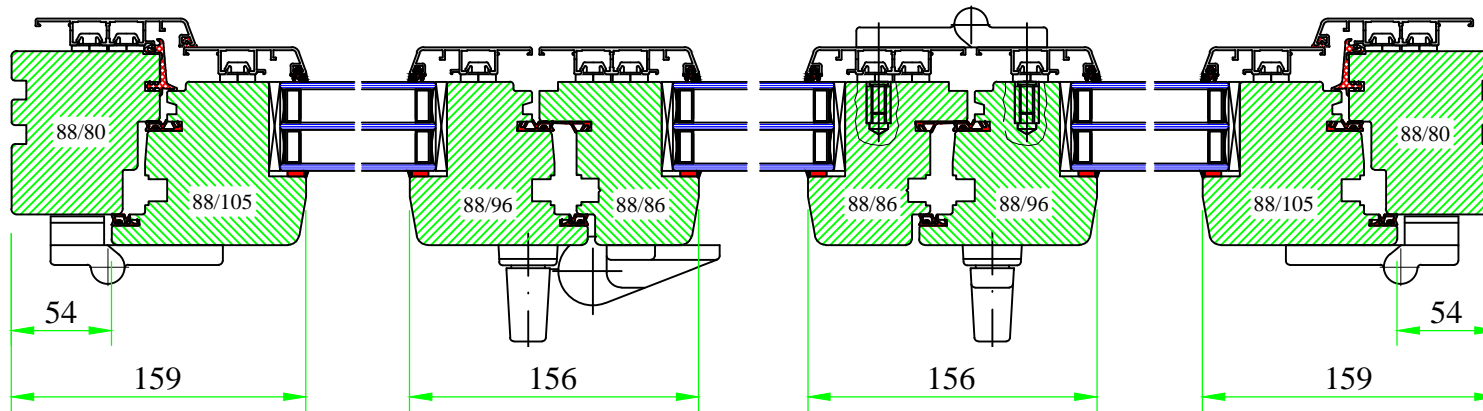

UNI WINDOWS Ltd.
 Unit 6, Edgefield Industrial Est.
 Loanhead, EH20 9TB
 Tel.: 0131 448 3931

Folding sliding door

THERMAX

Version: 1	Scale: 1:4
Date: 15.05.14	Drawing: NKK/4

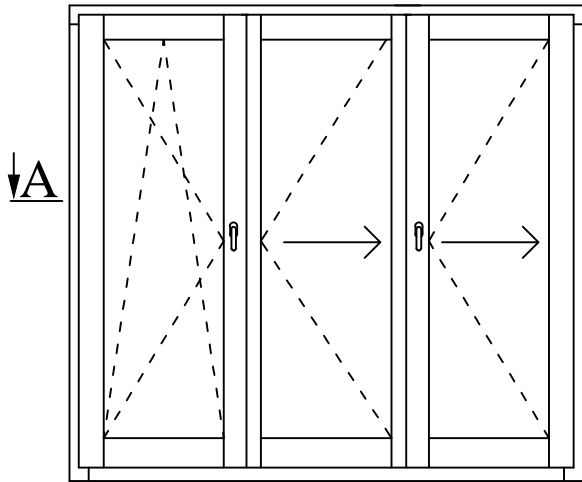

A

A-A

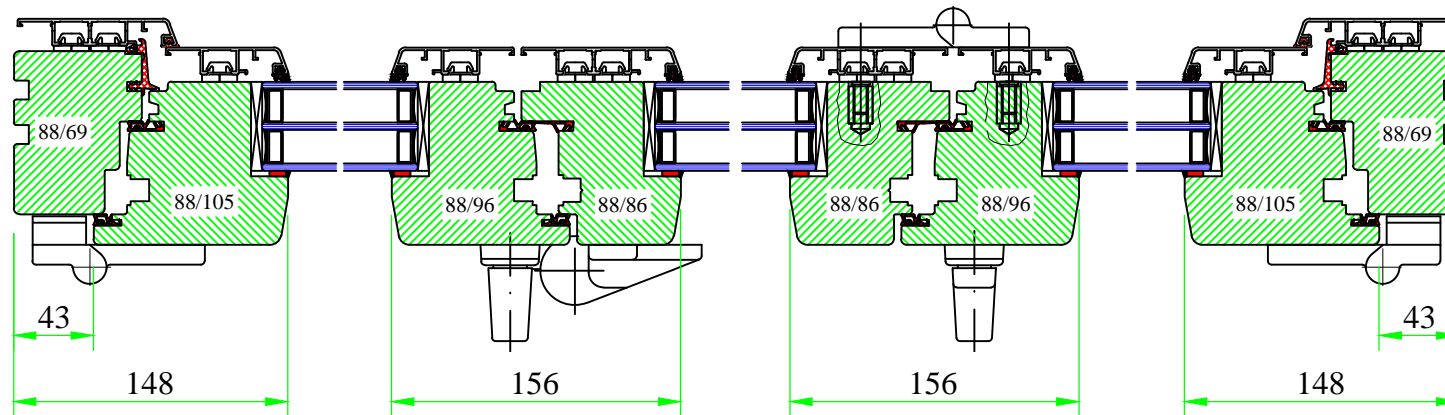

UNI WINDOWS Ltd.
 Unit 6, Edgefield Industrial Est.
 Loanhead, EH20 9TB
 Tel.: 0131 448 3931

Folding sliding door

THERMAX 2

Version:
1

Scale:
1:4

Date:
15.05.14

Drawing:
NKK/2-4

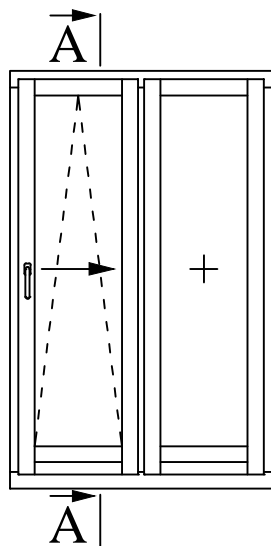

A-A

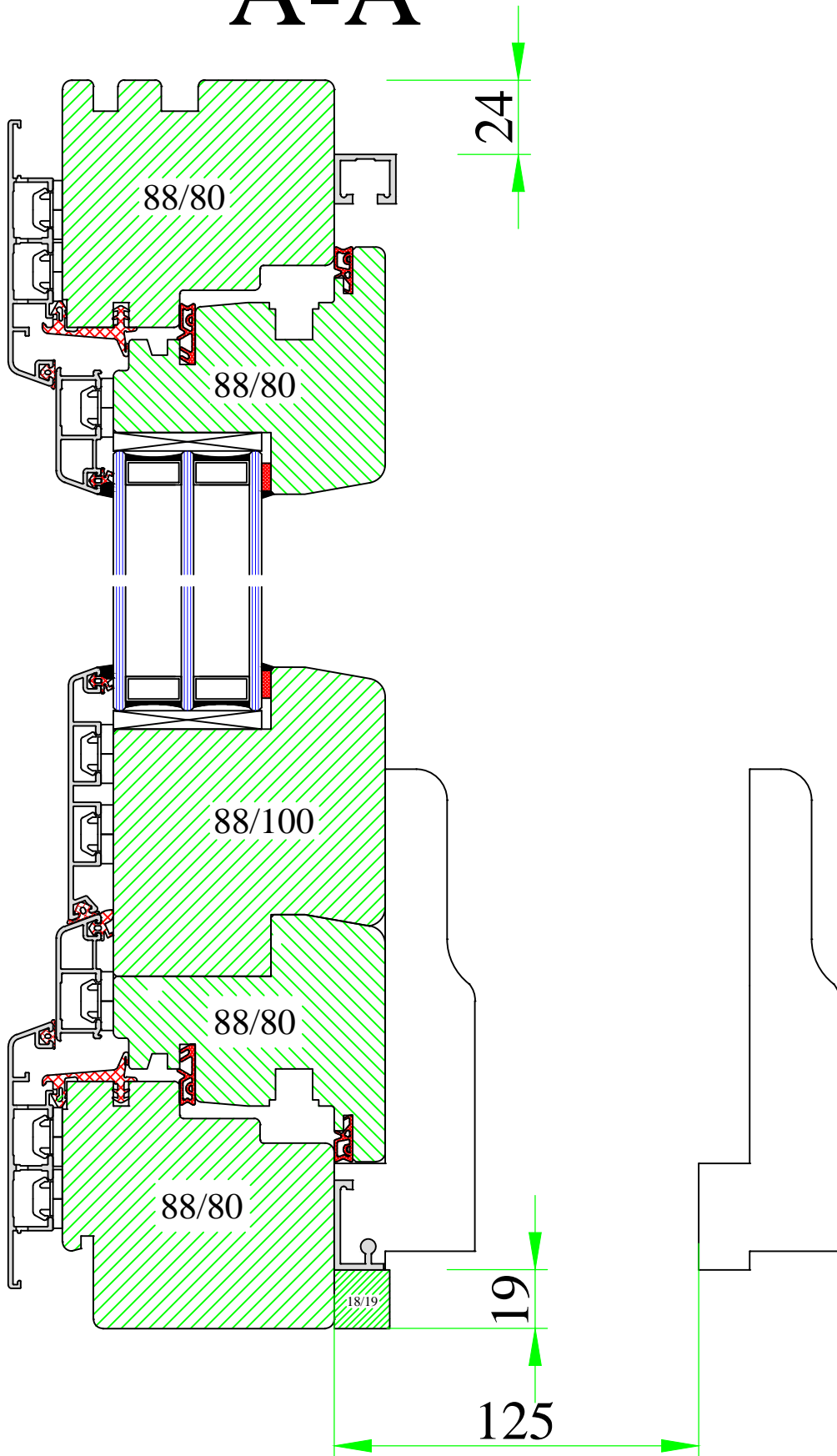

www.uniwin.co.uk



UNI WINDOWS Ltd.
 Unit 6, Edgefield Industrial Est.
 Loanhead, EH20 9TB
 Tel.: 0131 448 3931

Tilt and slide door

THERMAX

Version:
1

Scale:
1:2

Date:
15.05.14

Drawing:
NKK/8

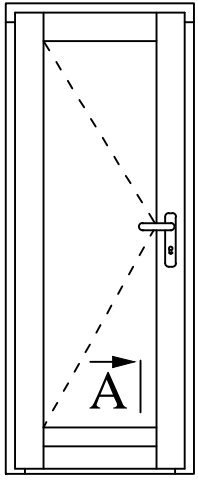

A

(out)

88/92

(in)

88/80

196

Y

15
13

100/15

24

www.uniwin.co.uk



UNI WINDOWS Ltd.
Unit 6, Edgefield Industrial Est.
Loanhead, EH20 9TB
Tel.: 0131 448 3931

THERMAX

External door with flat threshold Weser

Version:
1

Date:
15.05.14

Scale:
1:1

Drawing:
NKD/1

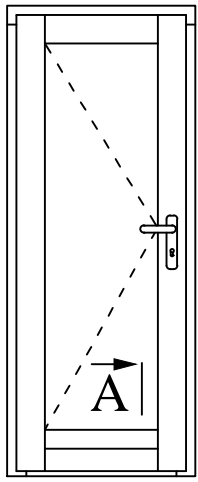

A

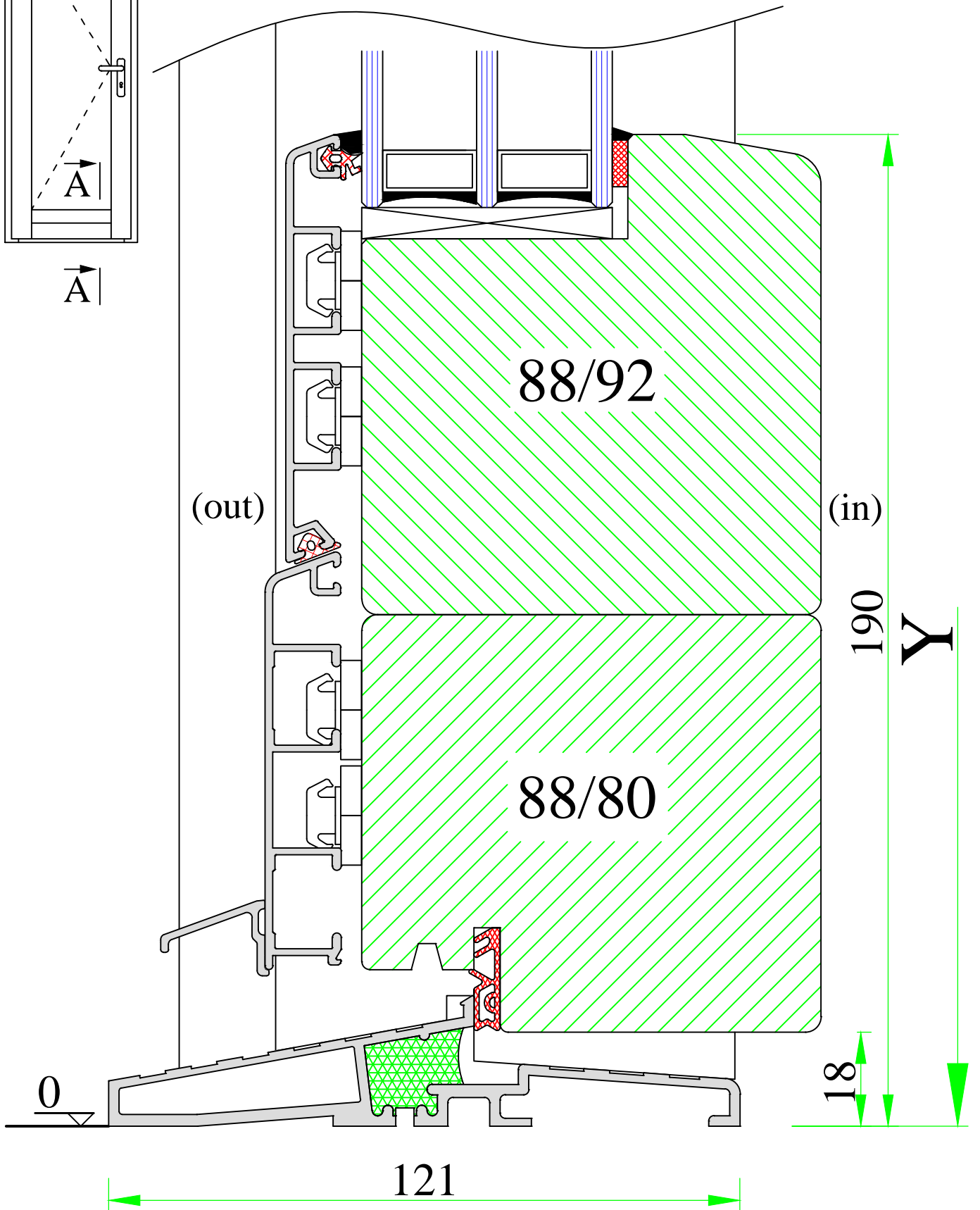

www.uniwin.co.uk



UNI WINDOWS Ltd.
 Unit 6, Edgefield Industrial Est.
 Loanhead, EH20 9TB
 Tel.: 0131 448 3931

THERMAX 1 / 2

External door with flat threshold DAFA

Version:
1

Scale:
1:1

Date:
15.05.14

Drawing:
NKD/2

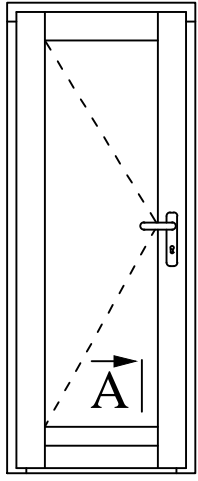

A

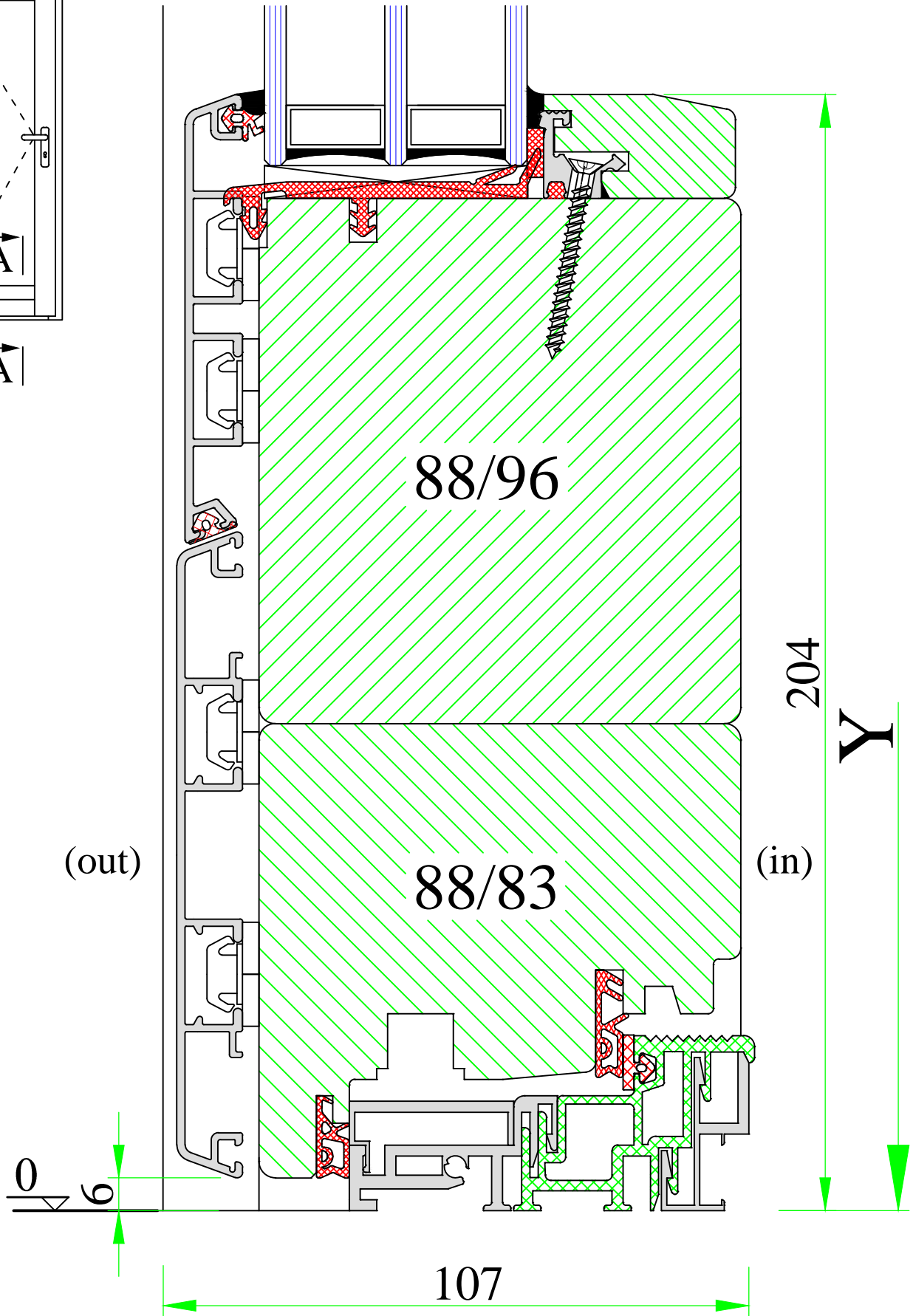

www.uniwin.co.uk



UNI WINDOWS Ltd.
 Unit 6, Edgefield Industrial Est.
 Loanhead, EH20 9TB
 Tel.: 0131 448 3931

THERMAX 1 / 2

External door with threshold Weser-A –
 outward opening

Version:
 1

Date:
 15.05.14

Scale:
 1:1

Drawing:
 NKD/3

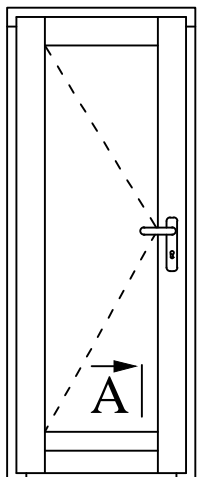

A

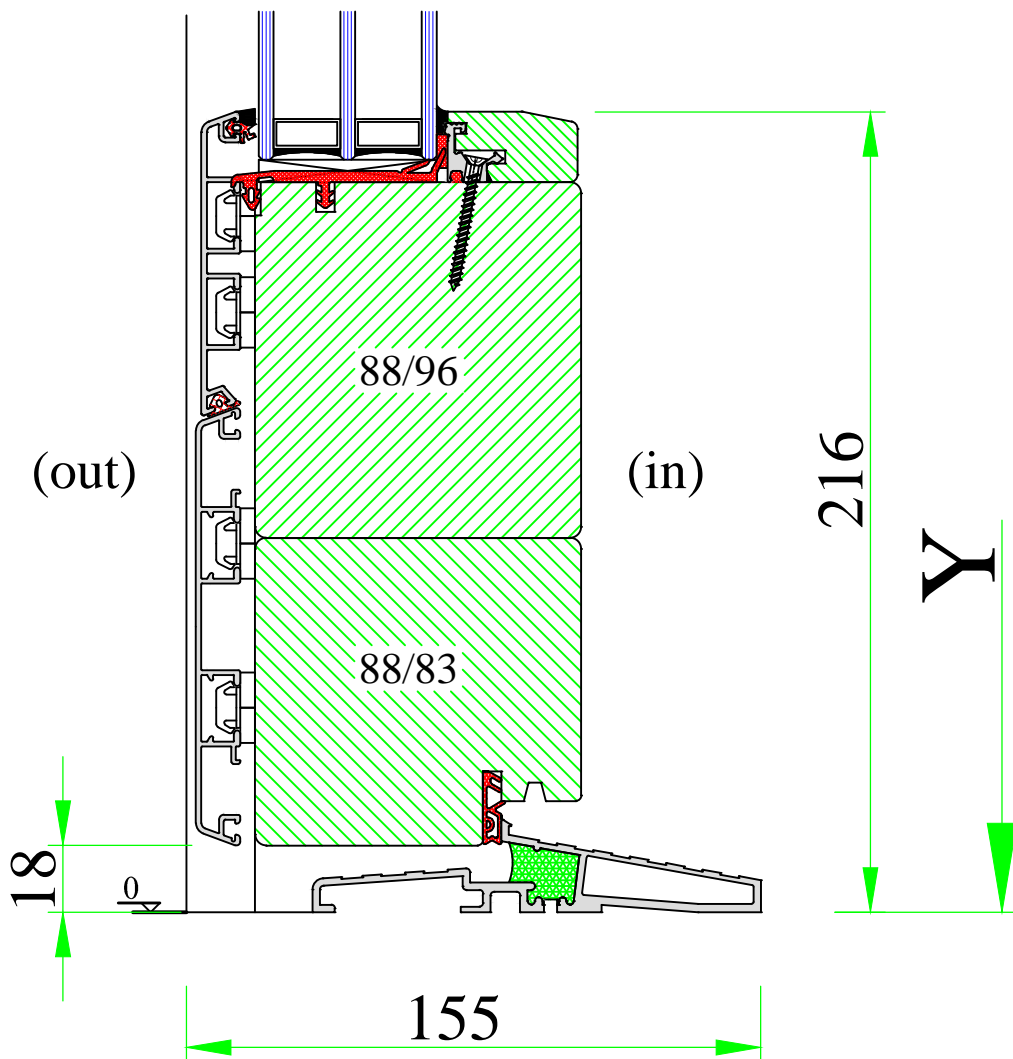

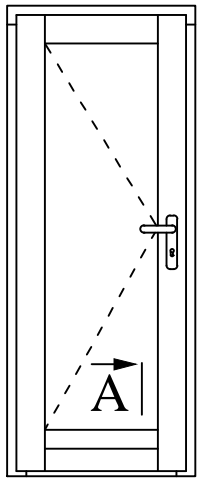

A

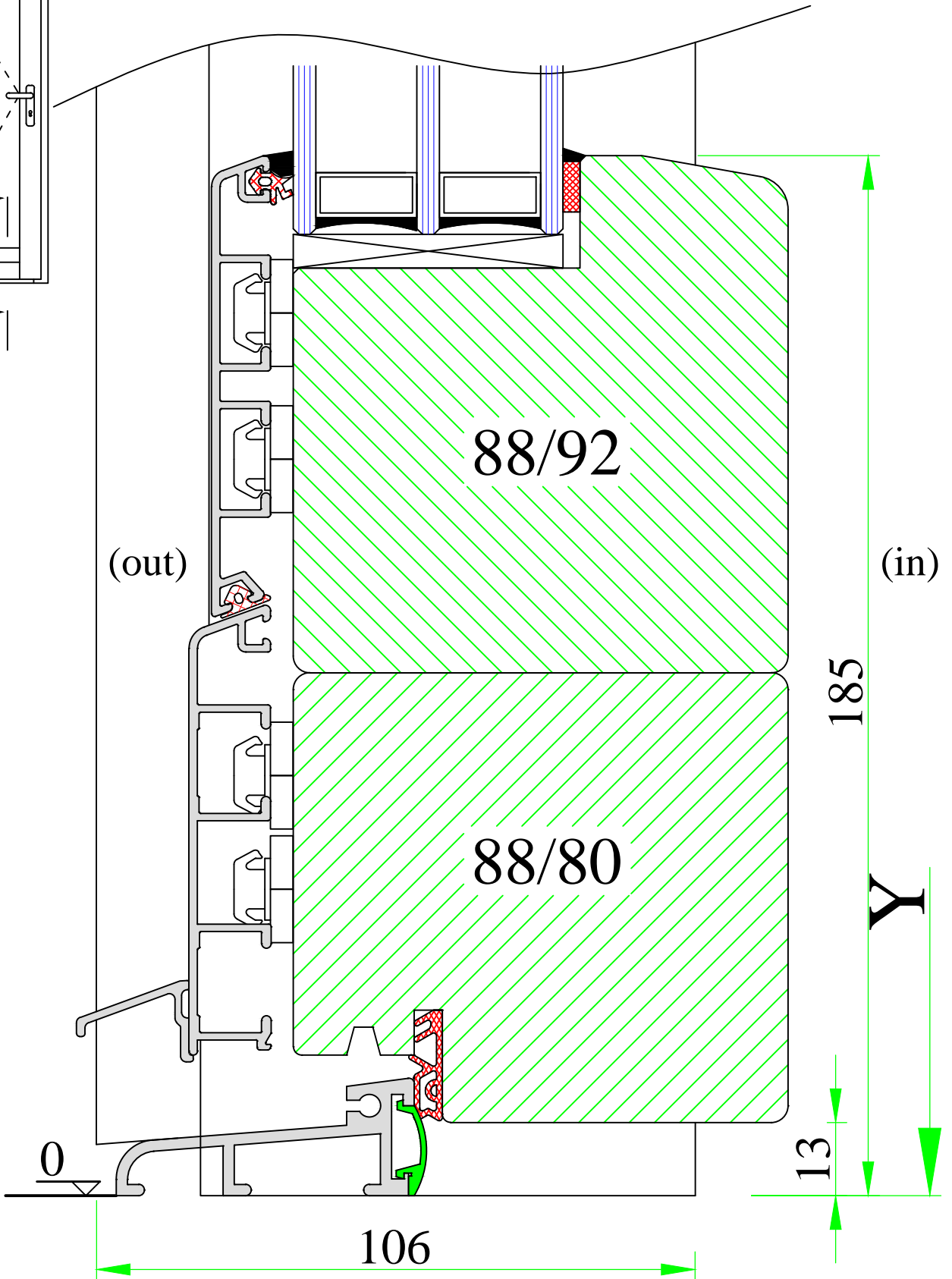

(out)

88/92

88/80

(in)

185

Y

0

106

13

www.uniwin.co.uk



UNI WINDOWS Ltd.
 Unit 6, Edgefield Industrial Est.
 Loanhead, EH20 9TB
 Tel.: 0131 448 3931

THERMAX
 External door with flat threshold Weser (old)

Version: 1	Scale: 1:1
Date: 15.05.14	Drawing: NKD/4

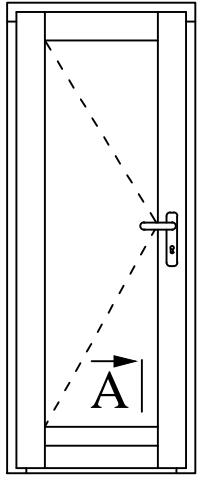

A

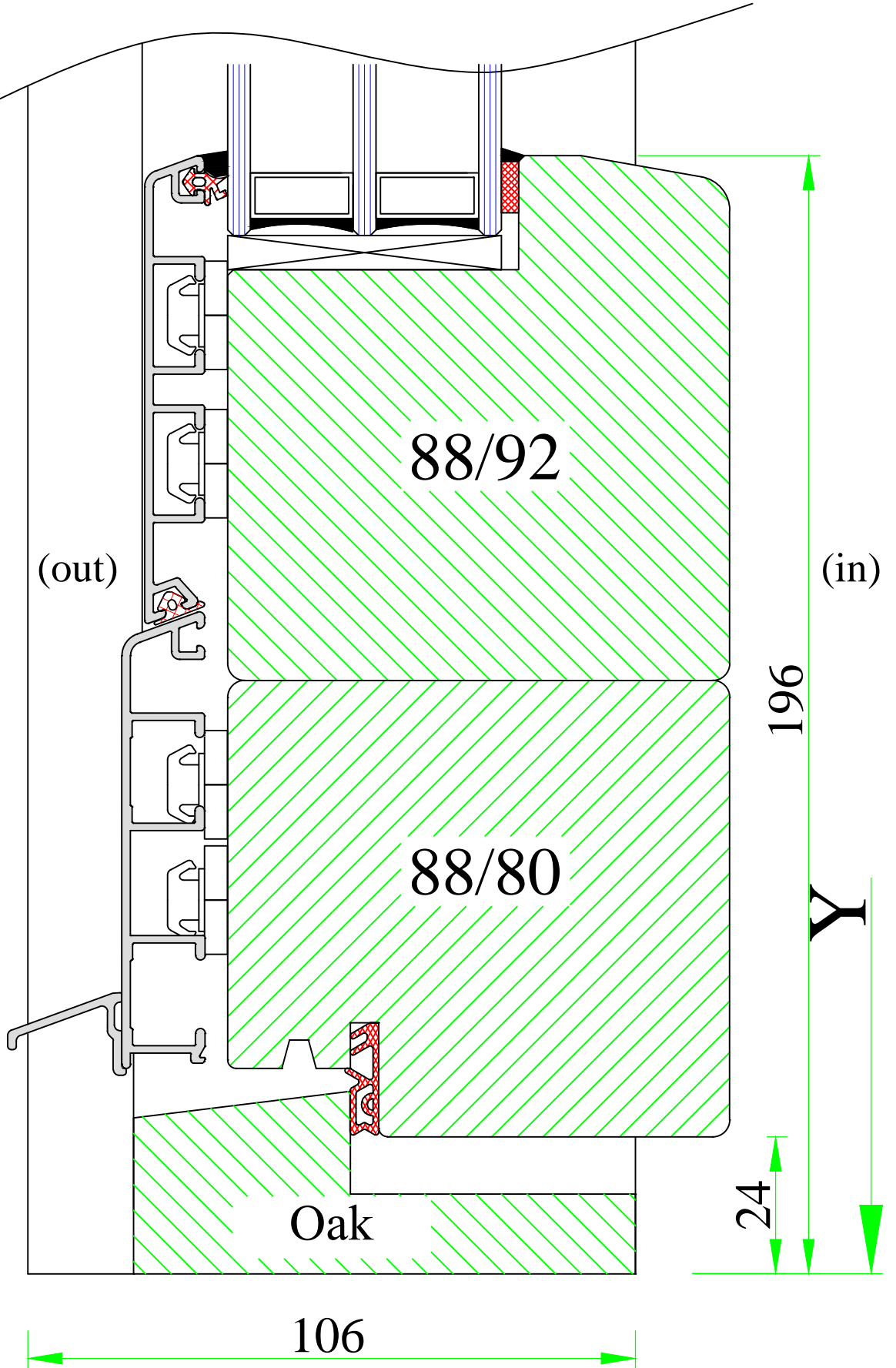

www.uniwin.co.uk



UNI WINDOWS Ltd.
 Unit 6, Edgefield Industrial Est.
 Loanhead, EH20 9TB
 Tel.: 0131 448 3931

THERMAX 1 / 2

Timber threshold for front door –
 – inward opening

Version: 1	Scale: 1:1
Date: 15.05.14	Drawing: NKD/5

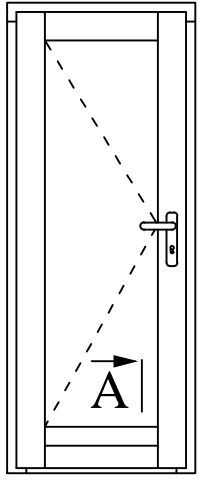

A

(out)

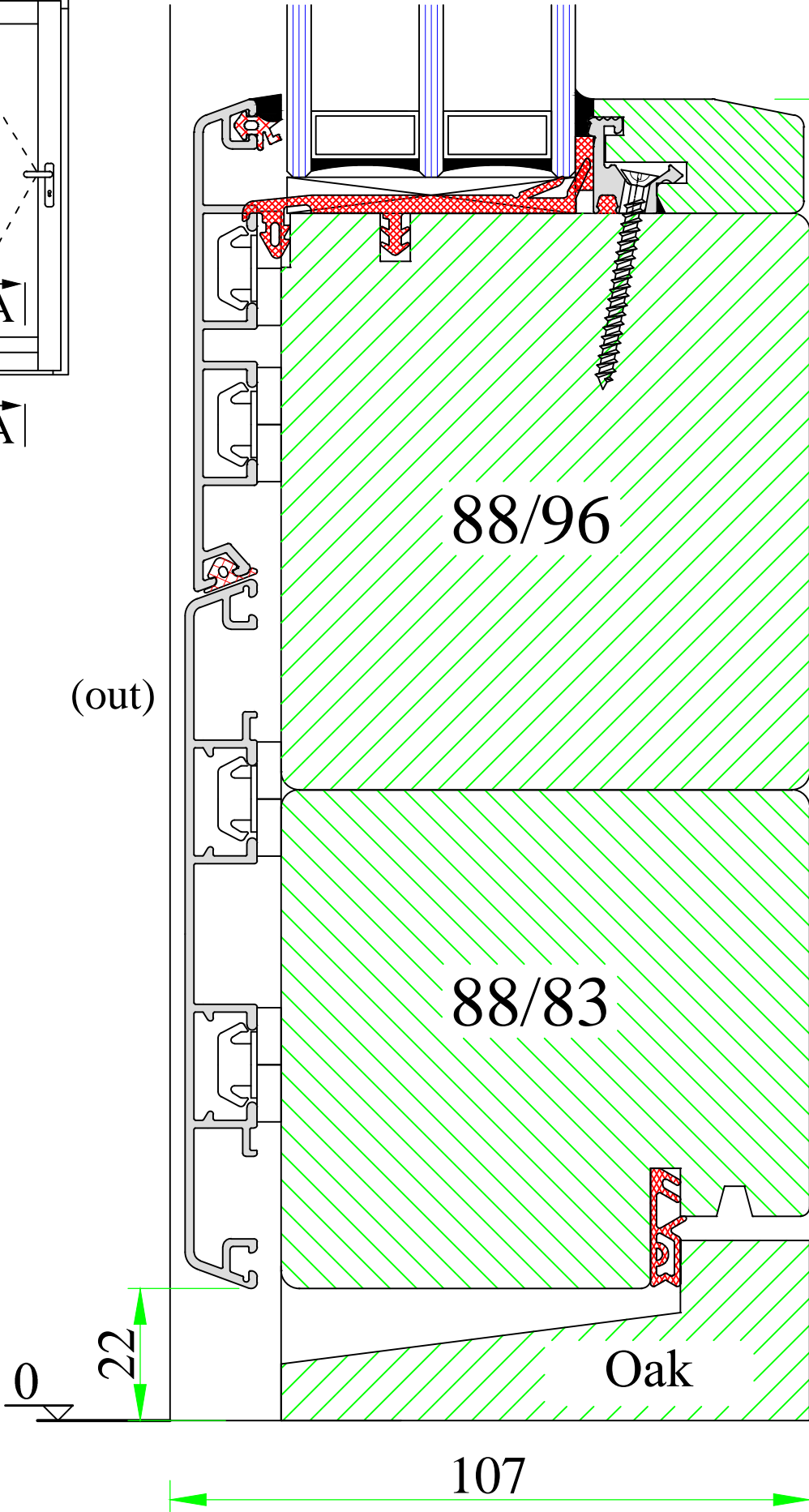

88/96

88/83

Oak

220

Y

107

(in)



UNI WINDOWS Ltd.
 Unit 6, Edgefield Industrial Est.
 Loanhead, EH20 9TB
 Tel.: 0131 448 3931

THERMAX 1 / 2

Timber threshold for front door –
 – outward opening

Version:
 1

Date:
 15.05.14

Scale:
 1:1

Drawing:
 NKD/6

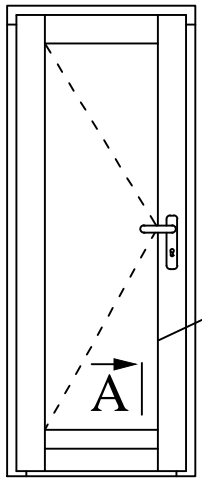

A

(out)

88/92

(in)

179

Y

88/80

15

3

7

121

www.uniwin.co.uk



UNI WINDOWS Ltd.
 Unit 6, Edgefield Industrial Est.
 Loanhead, EH20 9TB
 Tel.: 0131 448 3931

THERMAX 1 / 2

External door with ULT threshold

Version:
1

Scale:
1:1

Date:
15.05.14

Drawing:
NKD/7

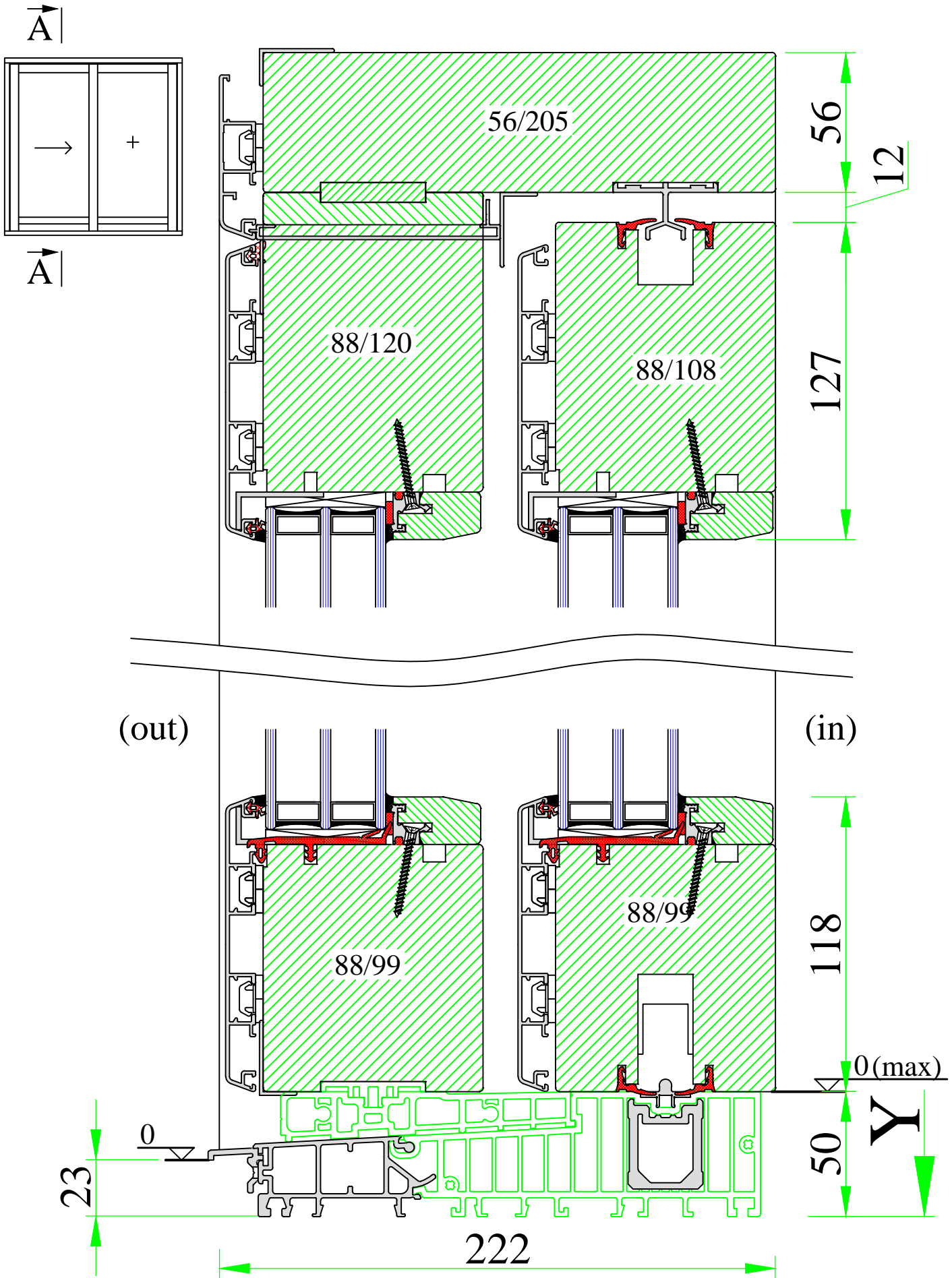

www.uniwin.co.uk



UNI WINDOWS Ltd.
 Unit 6, Edgefield Industrial Est.
 Loanhead, EH20 9TB
 Tel.: 0131 448 3931

THERMAX 1 / 2
 Lift and slide patio door – vertical cut

Version: 1	Scale: 1:2
Date: 15.05.14	Drawing: NKHS/1

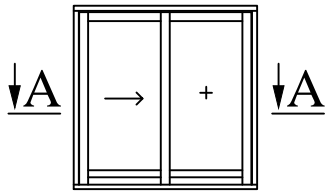

A-A

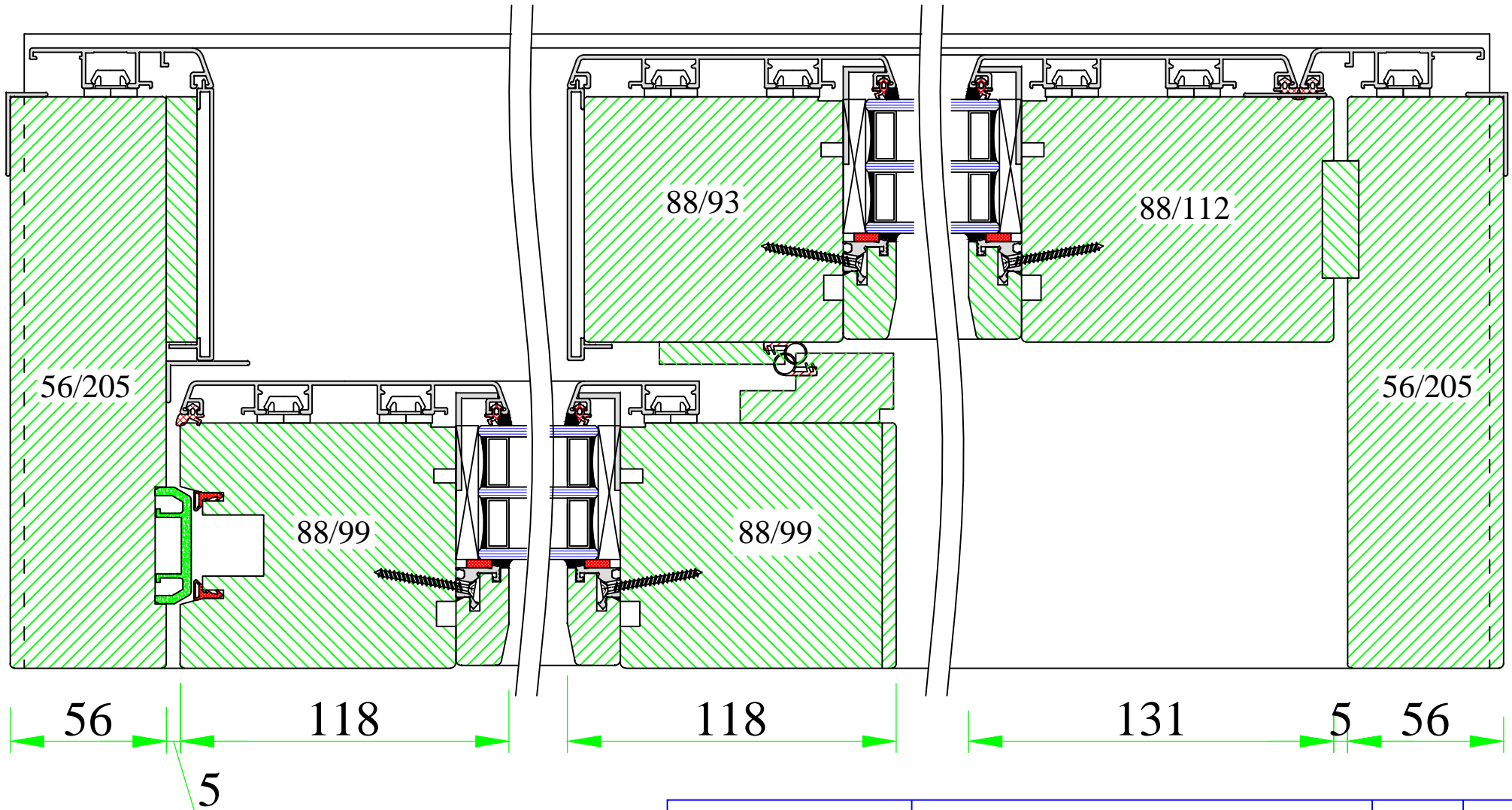

www.uniwin.co.uk



UNI WINDOWS Ltd.
 Unit 6, Edgefield Industrial Est.
 Loanhead, EH20 9TB
 Tel.: 0131 448 3931

THERMAX 1 / 2
 Lift and slide patio door – horizontal cut

Version: 1	Scale: 1:2
Date: 15.05.14	Drawing: NKHS/2

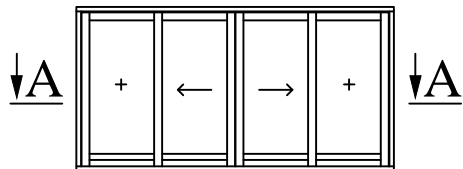

A-A

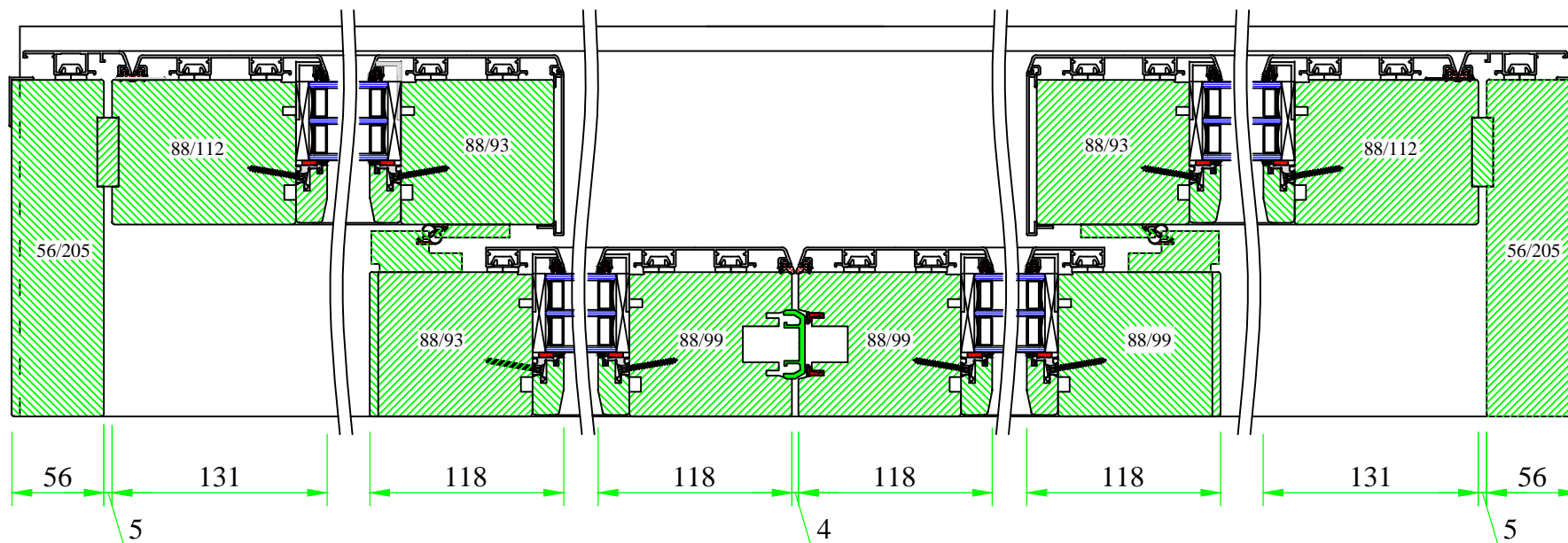

UNI WINDOWS Ltd.
 Unit 6, Edgefield Industrial Est.
 Loanhead, EH20 9TB
 Tel.: 0131 448 3931

THERMAX 1/ 2
 Lift and slide patio door, type C – horizontal cut

Version: 1	Scale: 1:2
Date: 15.05.14	Drawing: NKHS/4

→
A

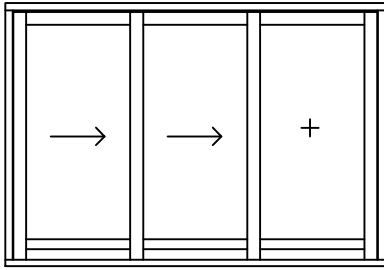

→
A

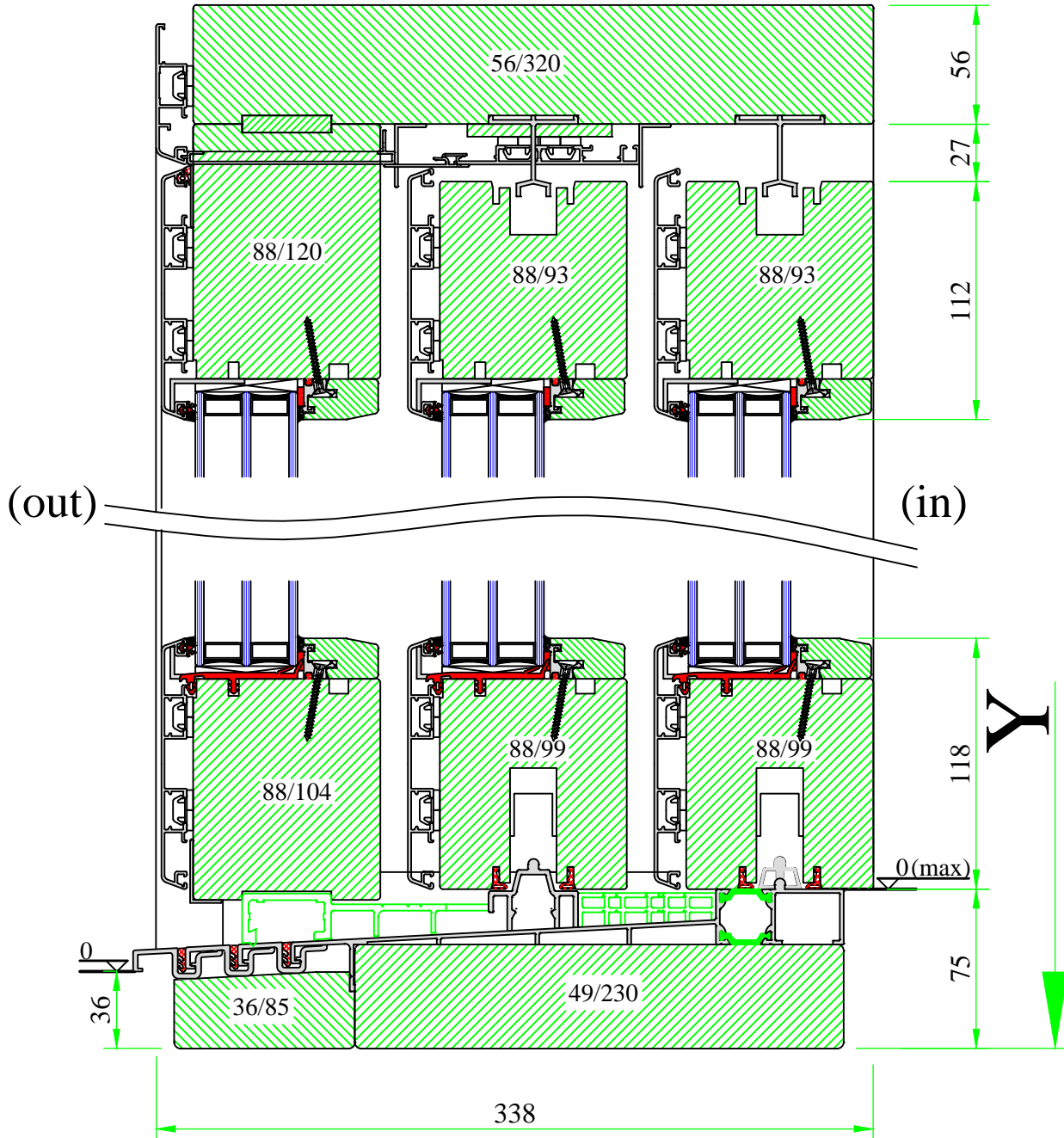

www.uniwin.co.uk



UNI WINDOWS Ltd.
 Unit 6, Edgefield Industrial Est.
 Loanhead, EH20 9TB
 Tel.: 0131 448 3931

THERMAX 1 / 2

Lift and slide patio door, type E – vertical cut

Version:
1

Date:
15.05.14

Scale:
1:2

Drawing:
NKHS/5

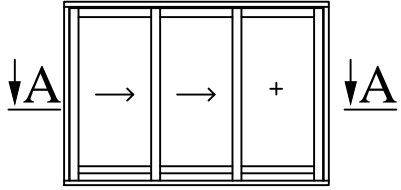

A-A

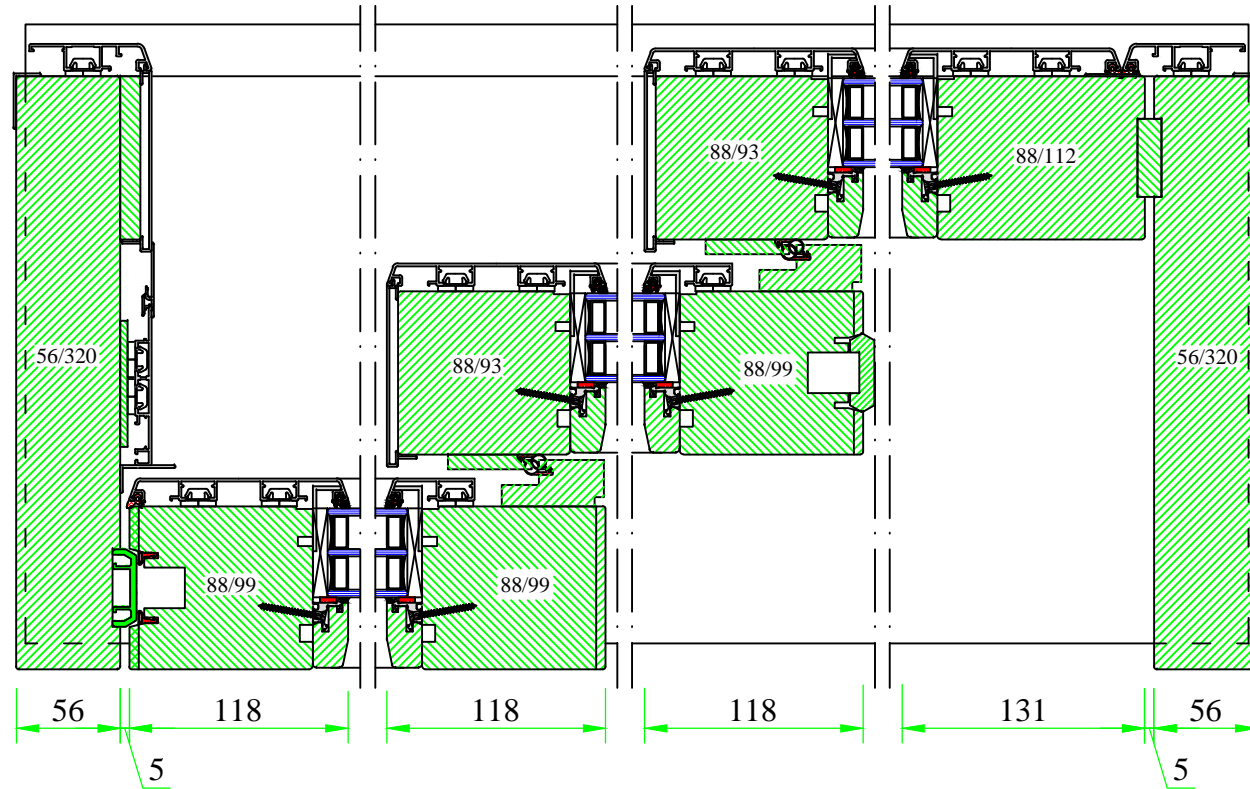

UNI WINDOWS Ltd.
 Unit 6, Edgefield Industrial Est.
 Loanhead, EH20 9TB
 Tel.: 0131 448 3931

THERMAX 1 / 2
 Lift and slide patio door, type E – horizontal cut

Version: 1	Scale: 1:2
Date: 15.05.14	Drawing: NKHS/6

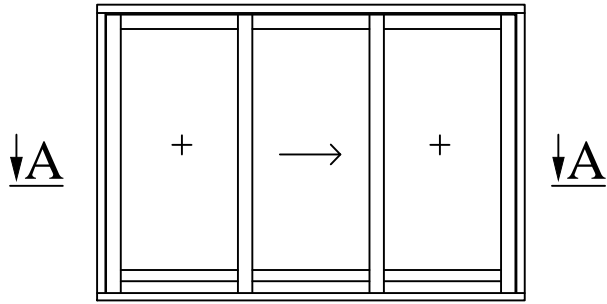

A-A

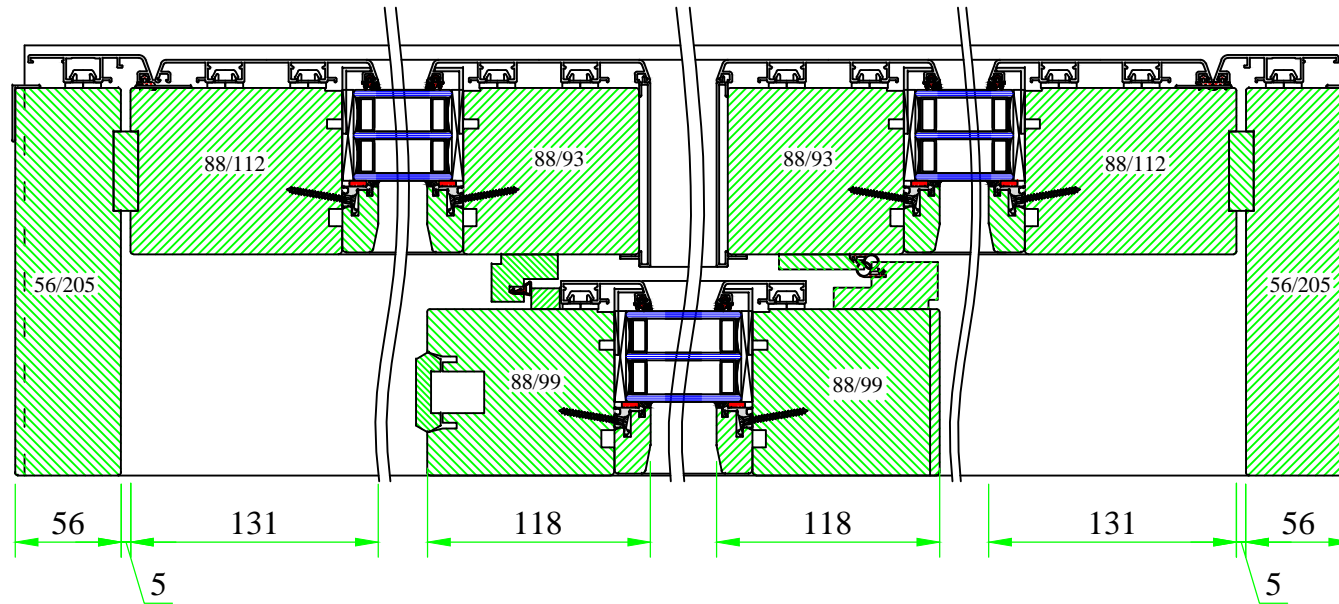

UNI WINDOWS Ltd.
 Unit 6, Edgefield Industrial Est.
 Loanhead, EH20 9TB
 Tel.: 0131 448 3931

THERMAX 1 / 2
 Lift and slide patio door, type G – horizontal cut

Version: 1	Scale: 1:4
Date: 15.05.14	Drawing: NKHS/7

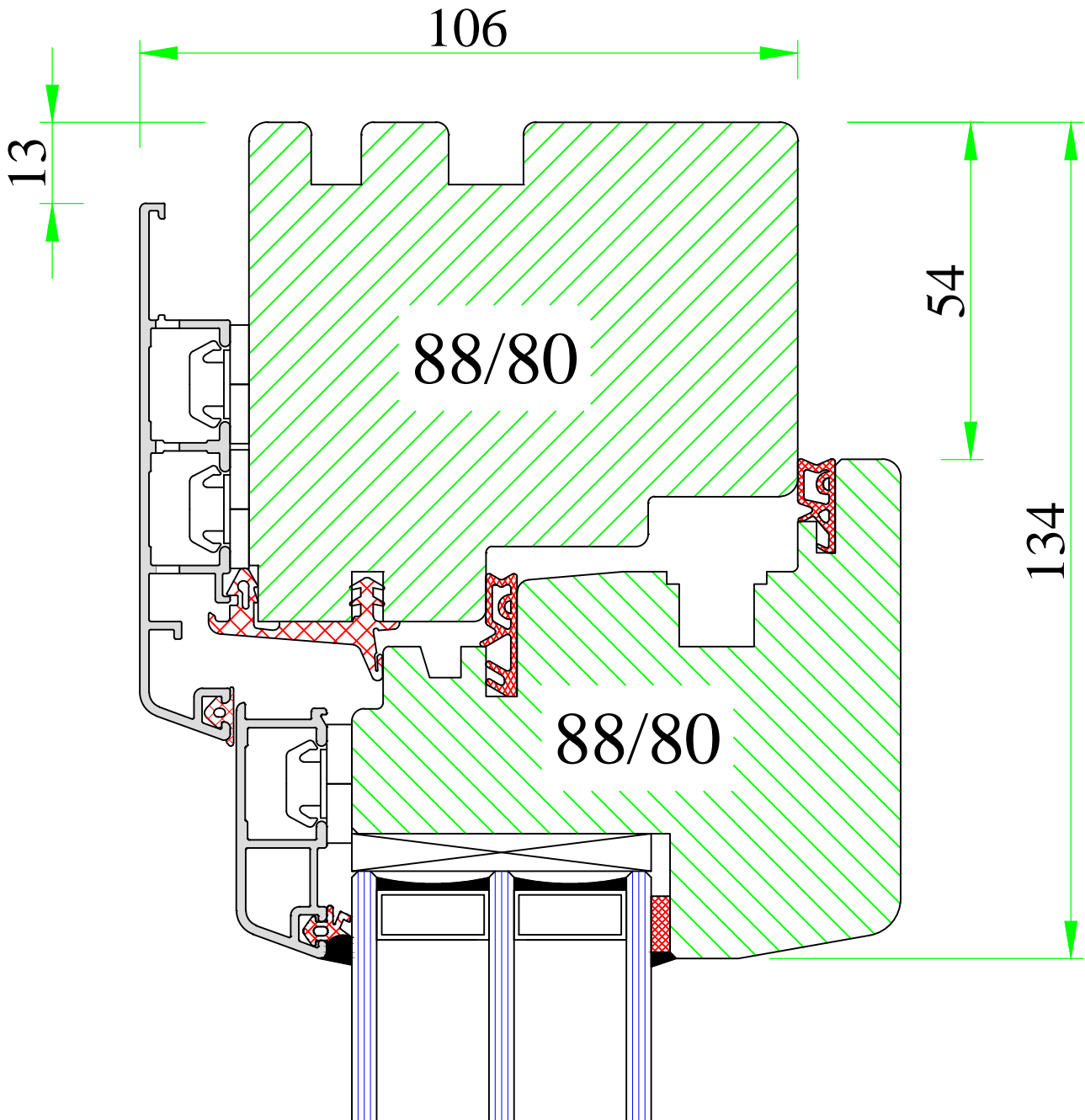
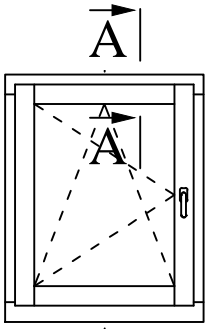

www.uniwin.co.uk



UNI WINDOWS Ltd.
 Unit 6, Edgefield Industrial Est.
 Loanhead, EH20 9TB
 Tel.: 0131 448 3931

THERMAX
 Frame-sash connection – top and sides

Version: 1	Scale: 1:1
Date: 15.05.14	Drawing: NK/1

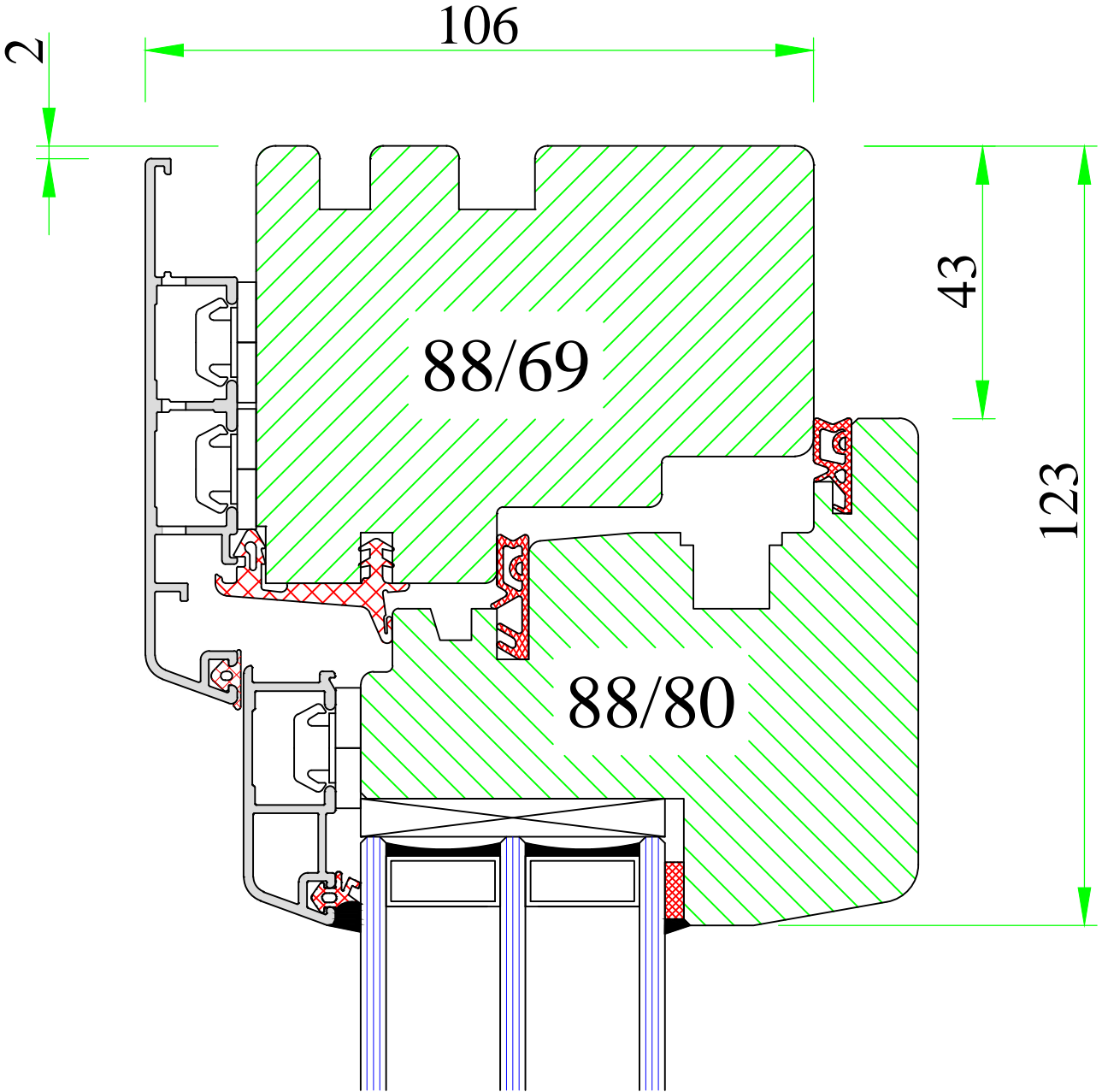
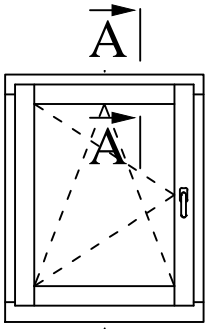

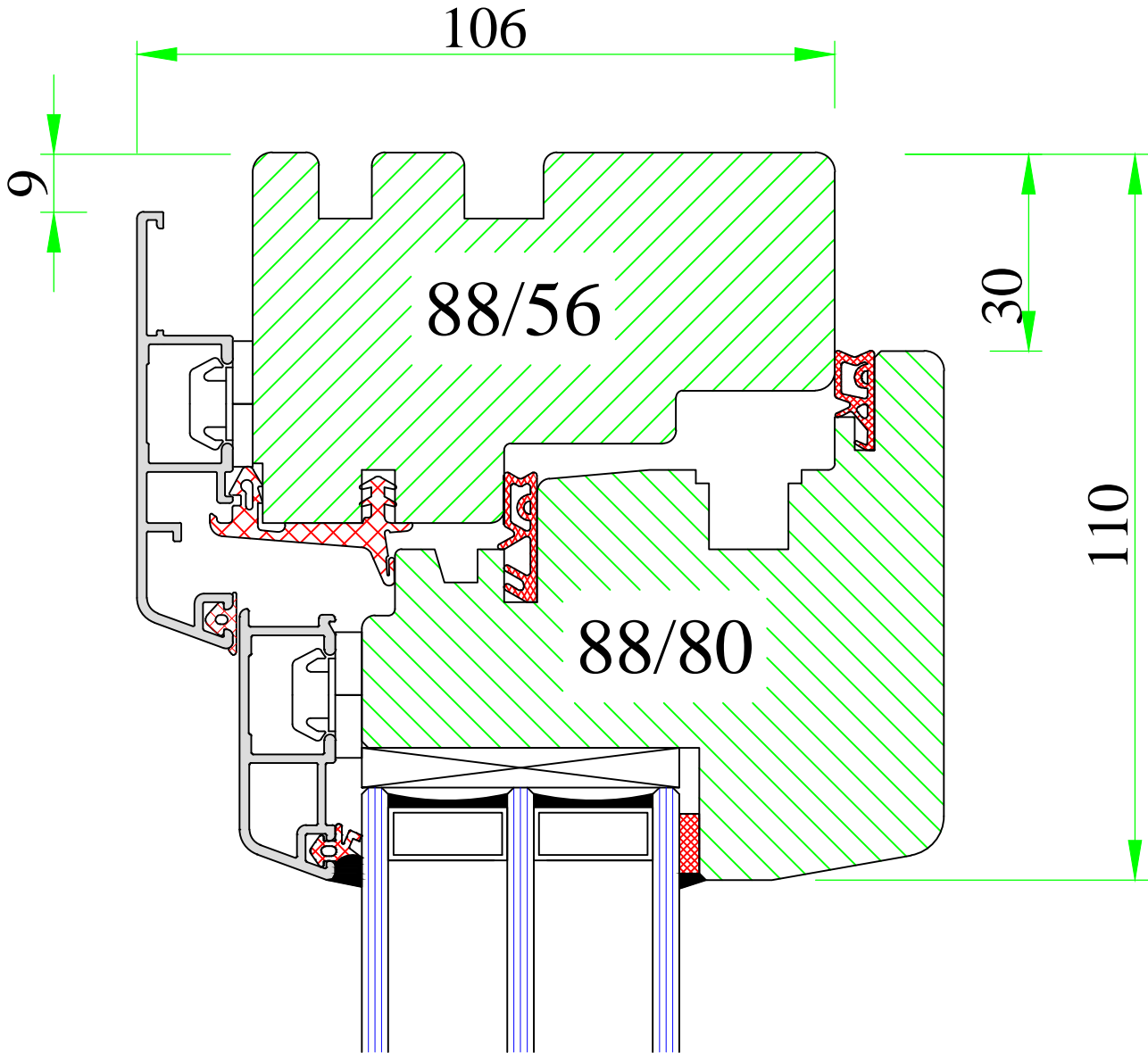
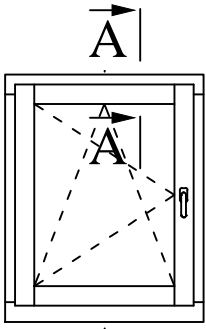

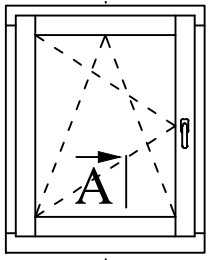

A

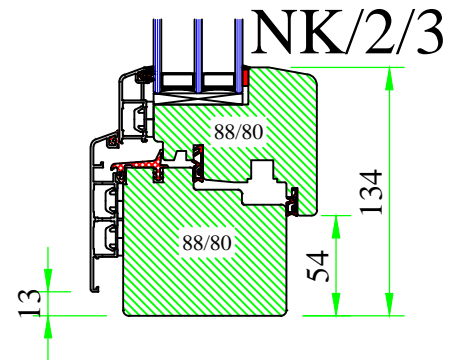
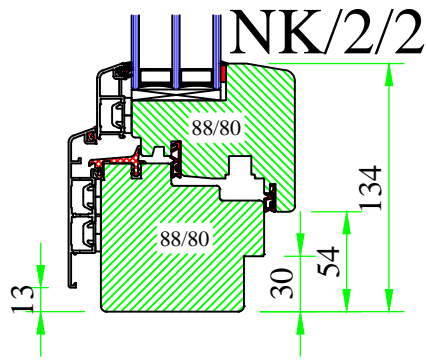
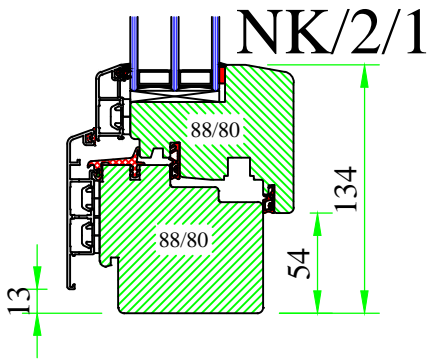
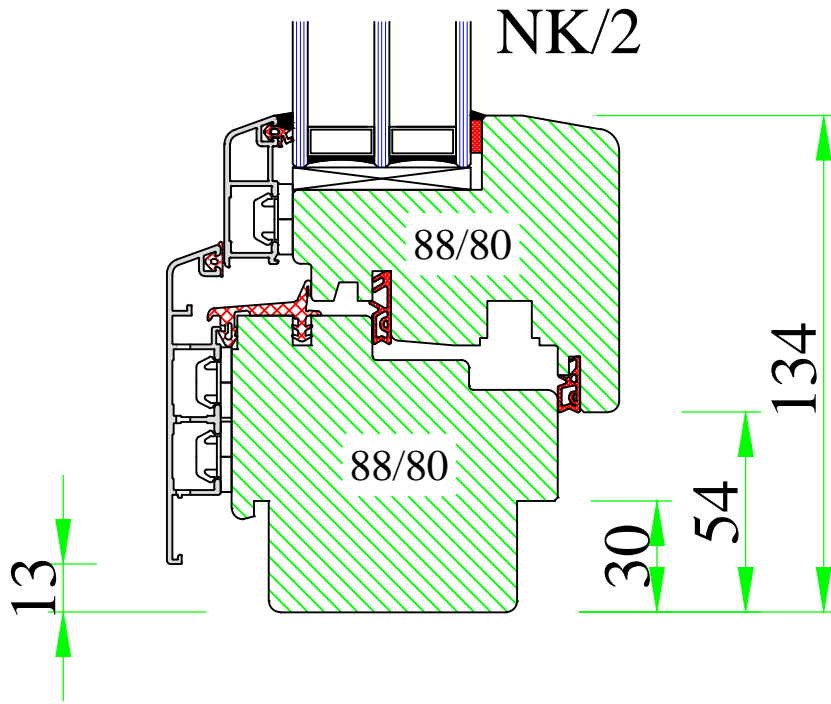

UNI WINDOWS Ltd.
 Unit 6, Edgefield Industrial Est.
 Loanhead, EH20 9TB
 Tel.: 0131 448 3931

THERMAX
 Frame-sash connection – undercut options

Version: 1	Scale: 1:2
Date: 15.05.14	Drawing: NK/2

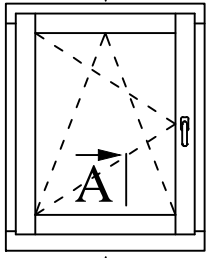

A

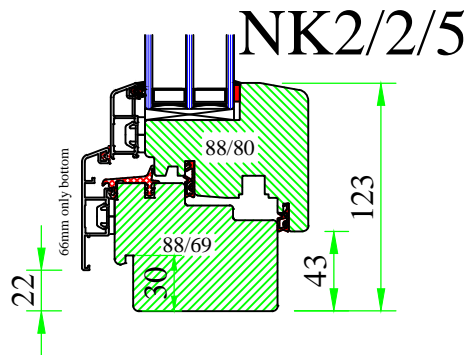
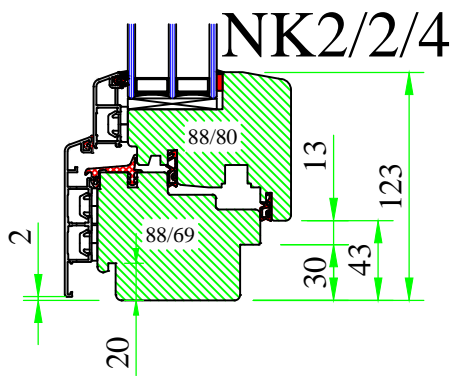
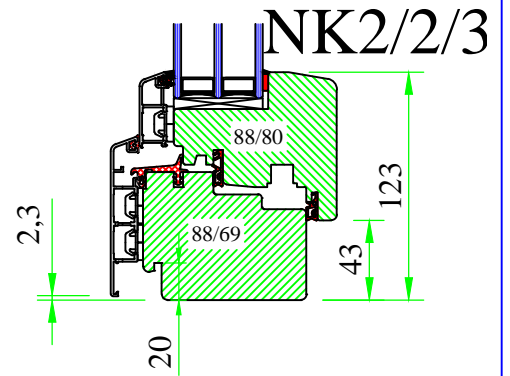
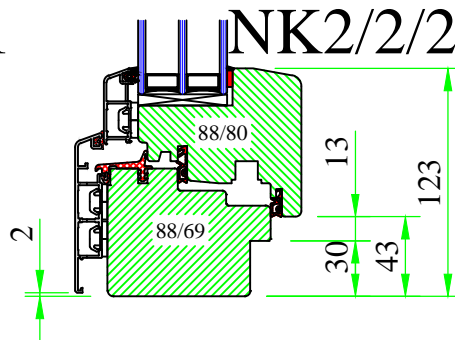
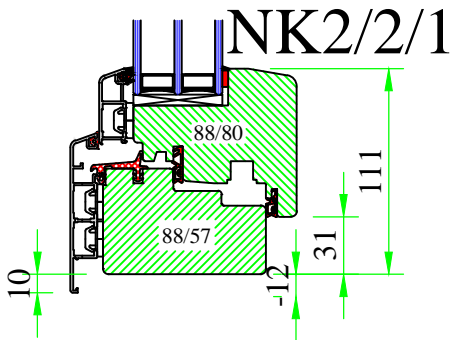
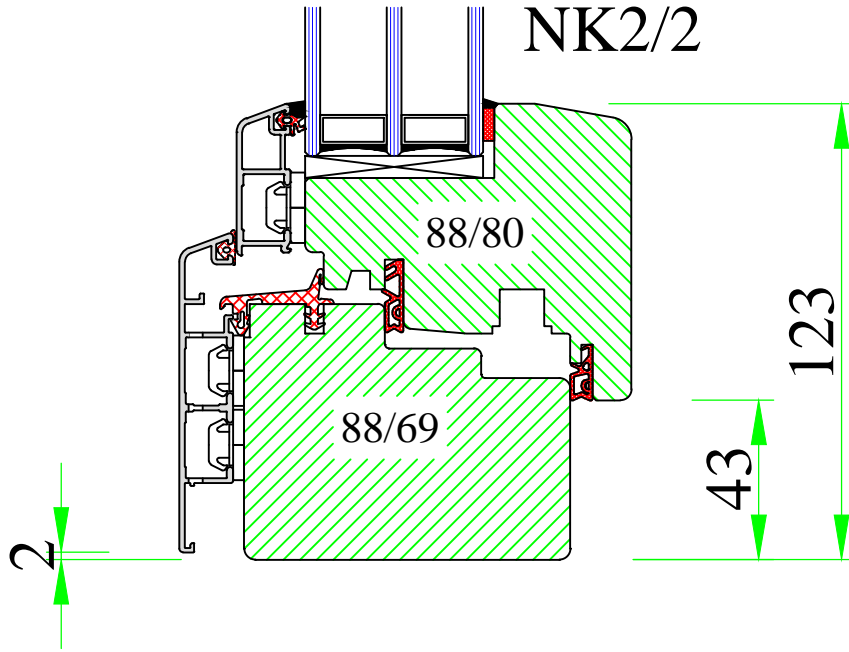

UNI WINDOWS Ltd.
 Unit 6, Edgefield Industrial Est.
 Loanhead, EH20 9TB
 Tel.: 0131 448 3931

THERMAX 2
 Frame-sash connection – undercut options

Version: 1	Scale: 1:2
Date: 15.05.14	Drawing: NK2/2

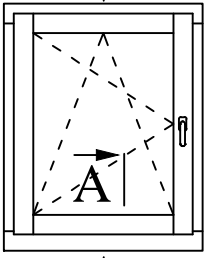

A

9

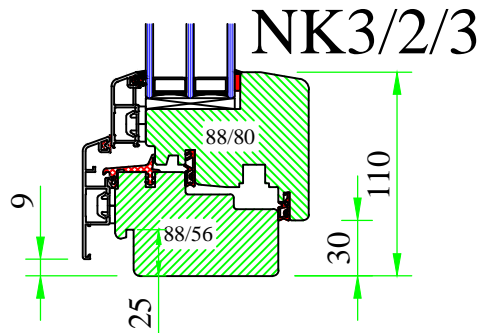
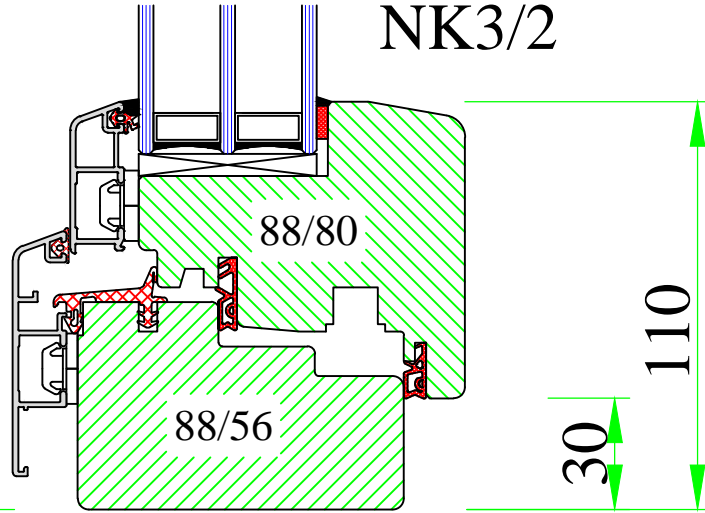

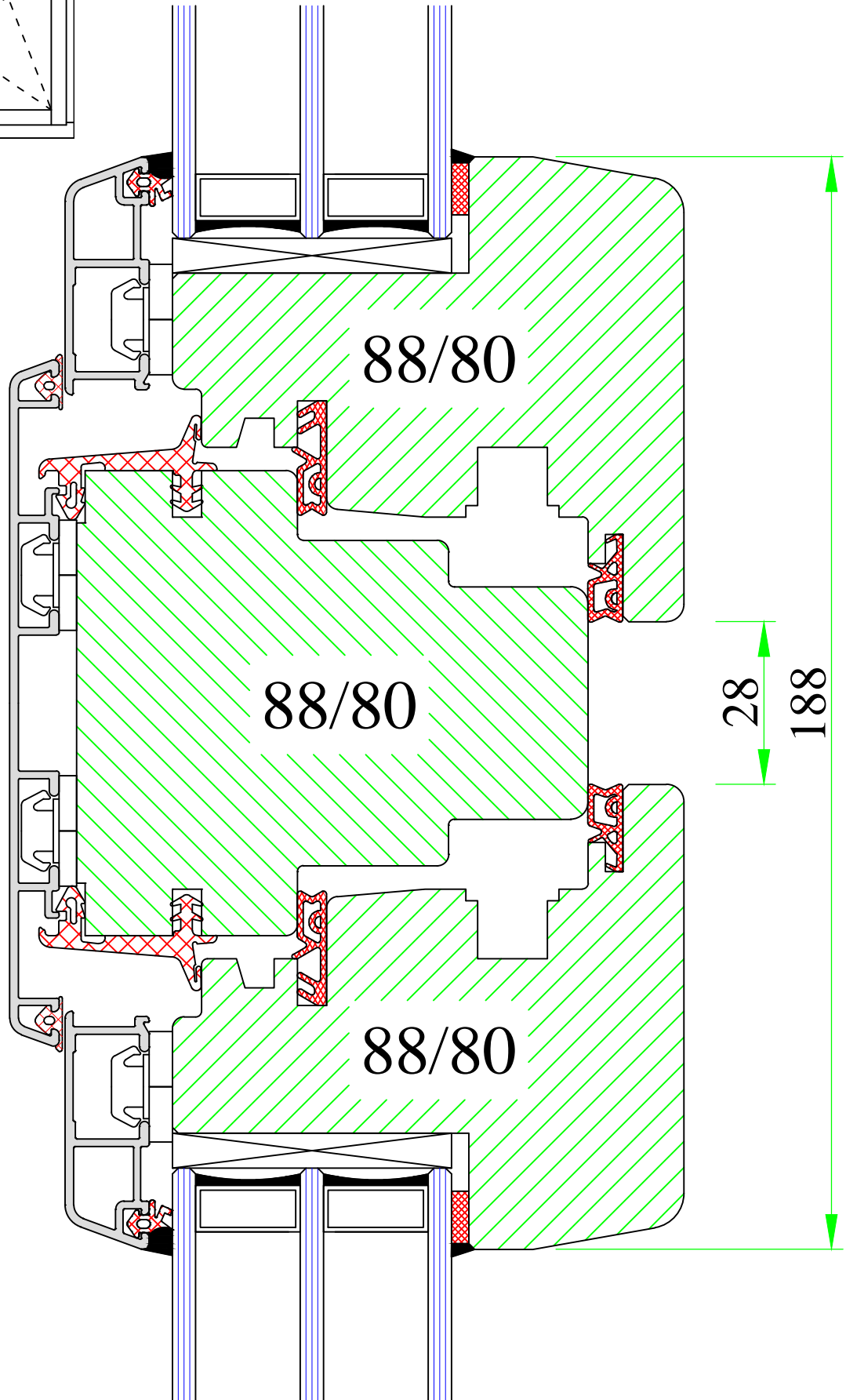
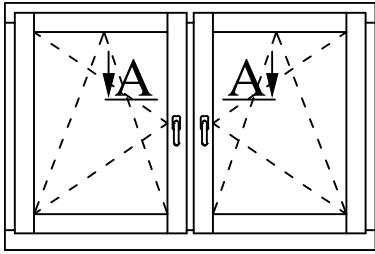

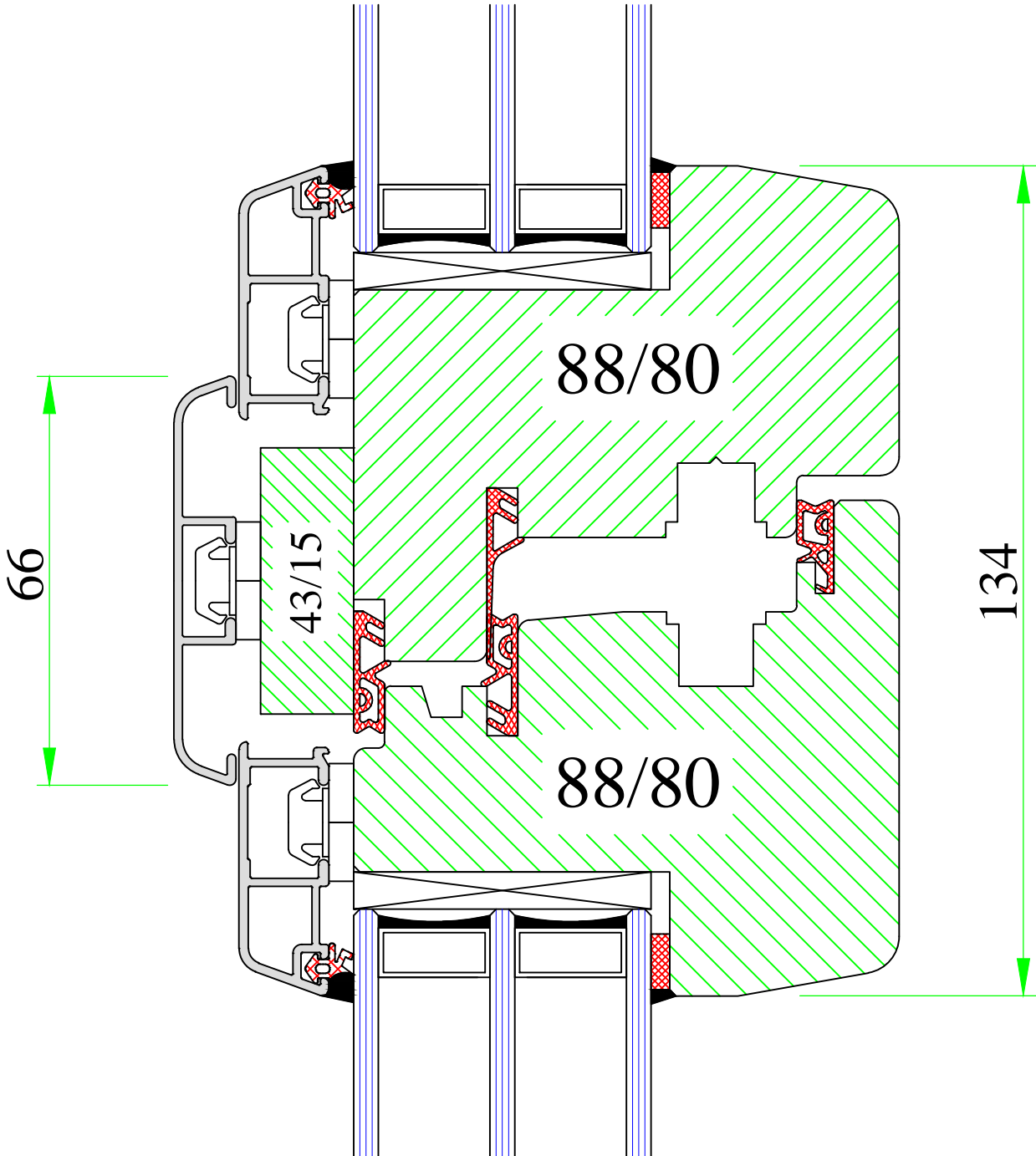
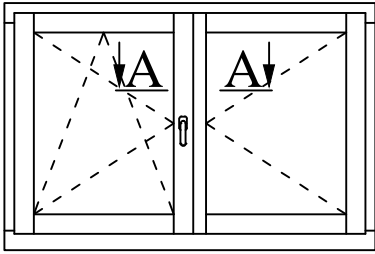

UNI WINDOWS Ltd.
 Unit 6, Edgefield Industrial Est.
 Loanhead, EH20 9TB
 Tel.: 0131 448 3931

THERMAX 1 / 2
 Double opening window - 'flying' mullion

Version: 1	Scale: 1:1
Date: 15.05.14	Drawing: NK/5

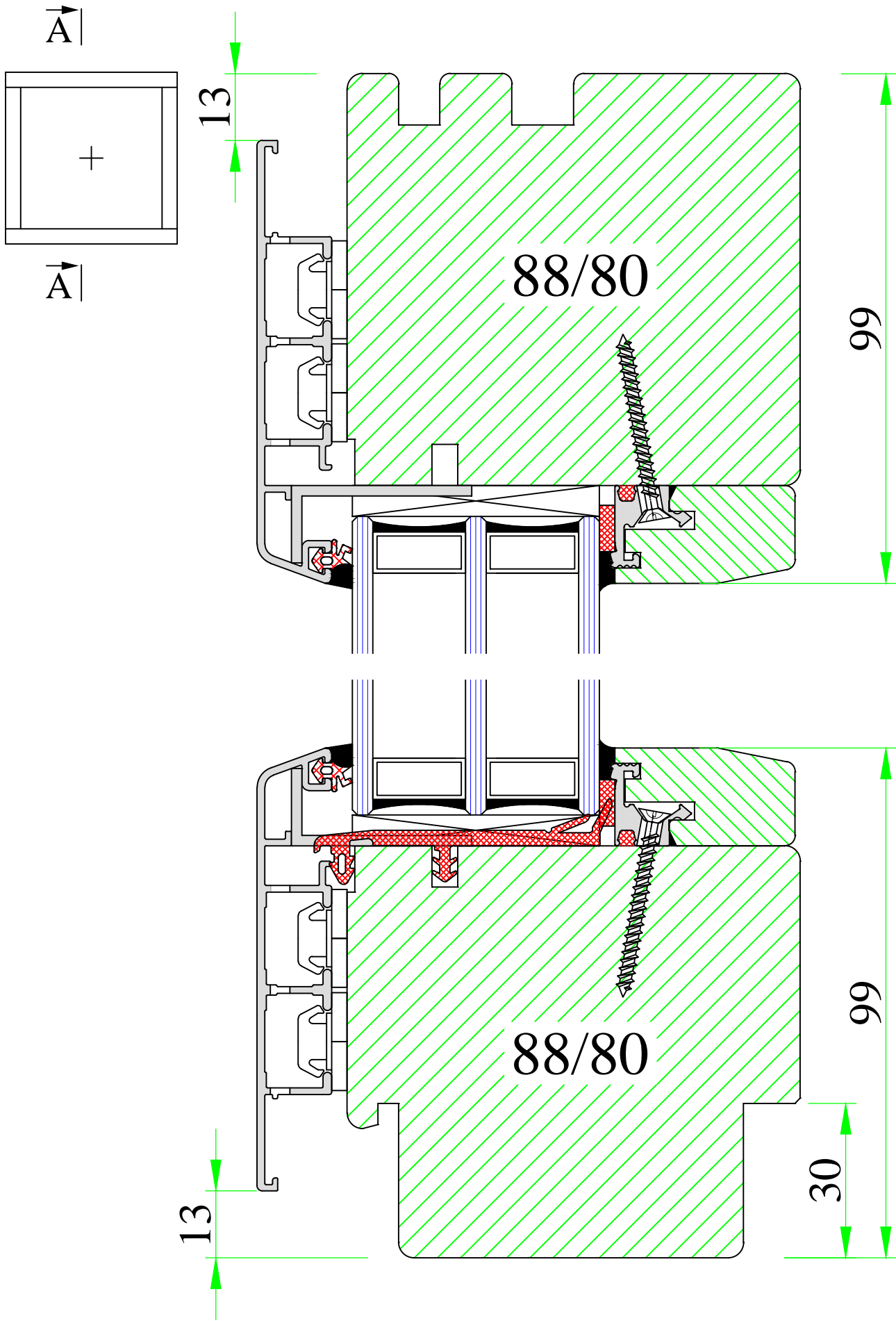

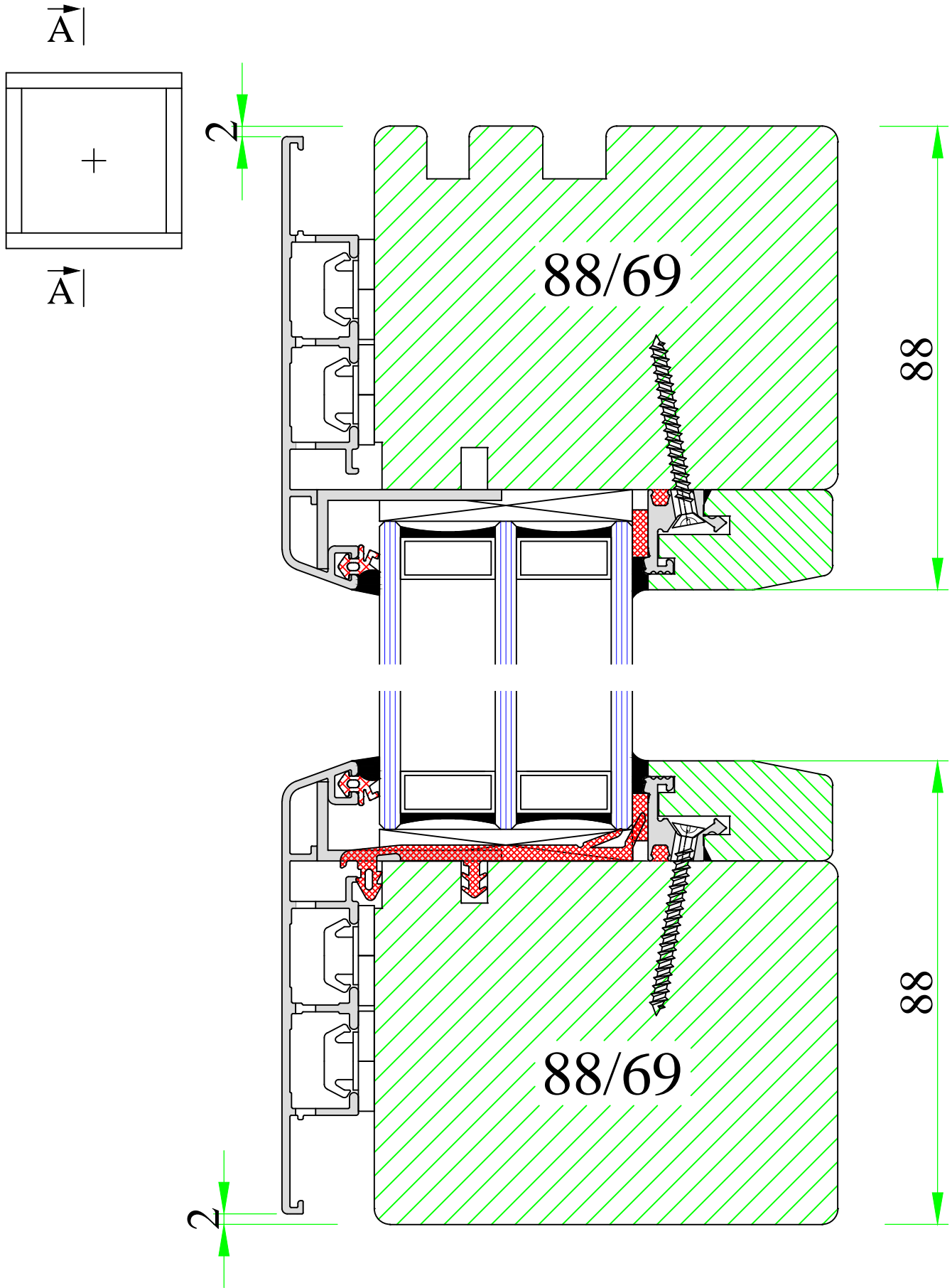

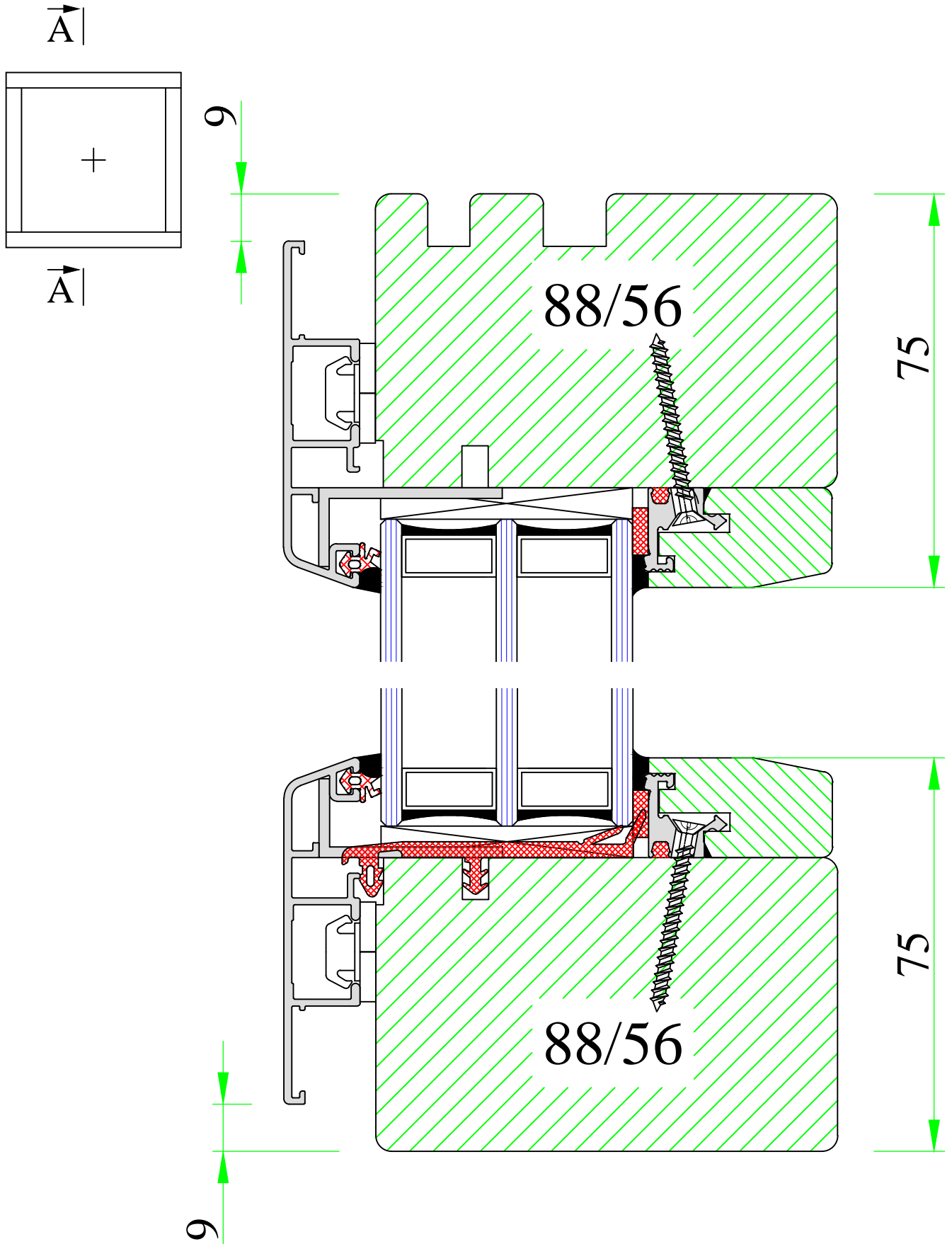

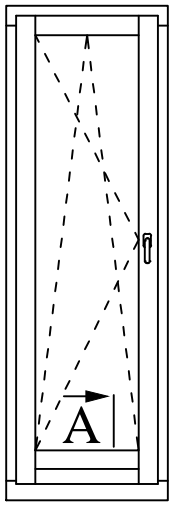

A

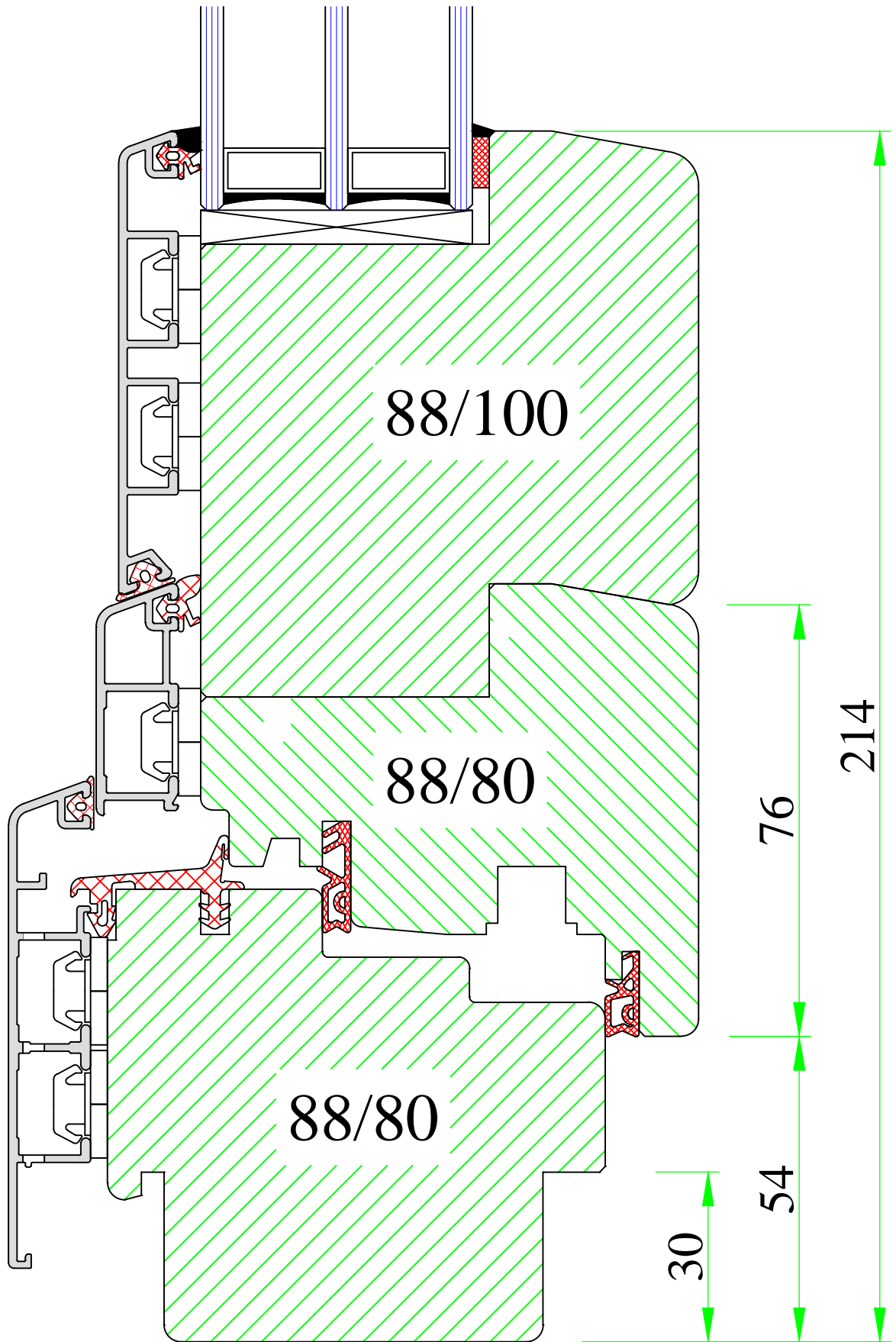

www.uniwin.co.uk



UNI WINDOWS Ltd.
 Unit 6, Edgefield Industrial Est.
 Loanhead, EH20 9TB
 Tel.: 0131 448 3931

THERMAX
 Frame-sash connection – bottom of balcony door

Version: 1	Scale: 1:1
Date: 15.05.14	Drawing: NK/7

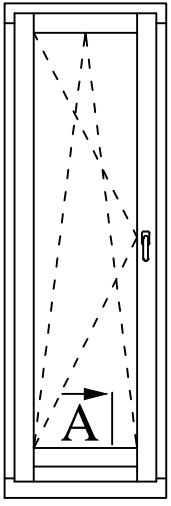

A

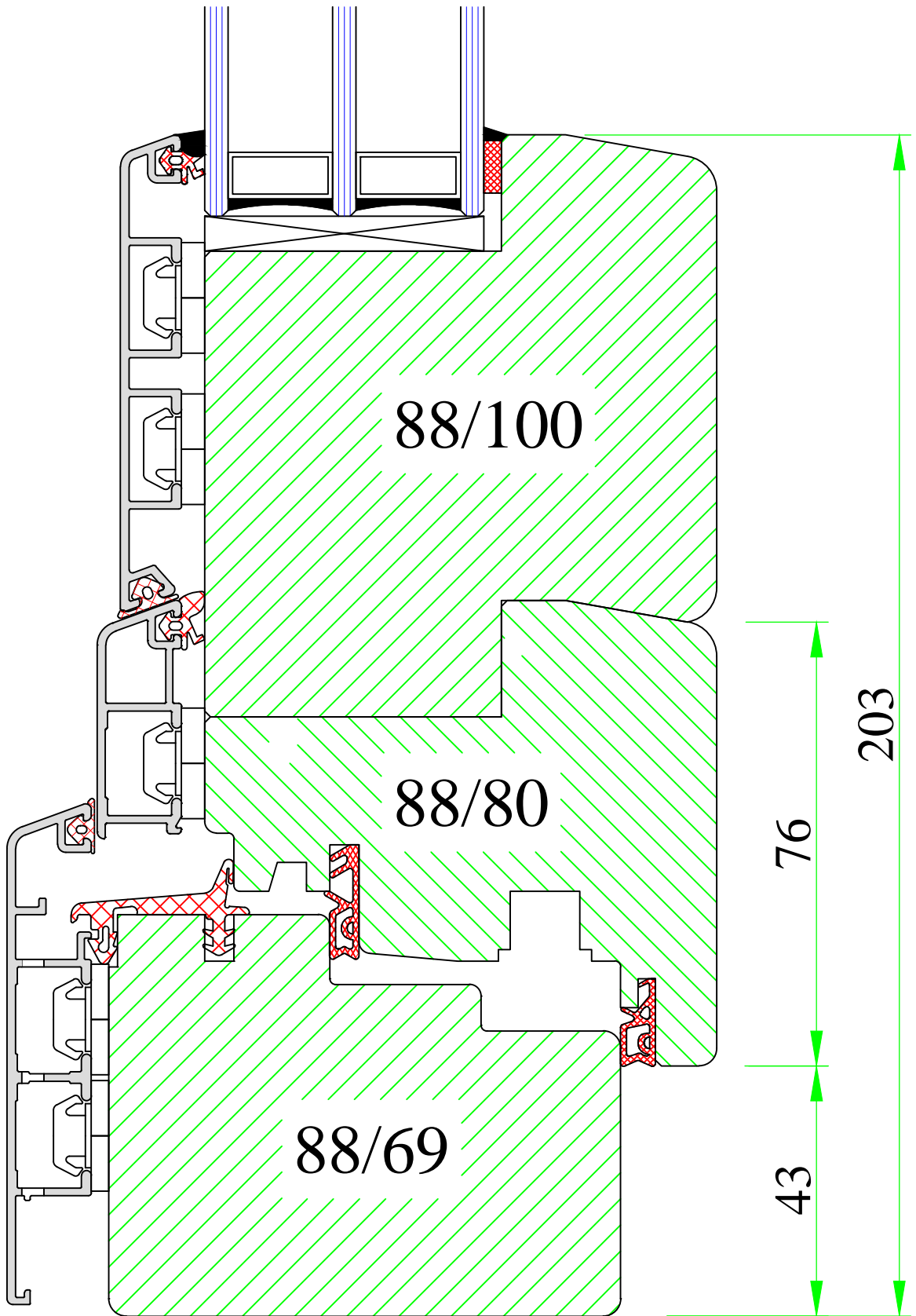

88/100

88/80

88/69

76

203

43

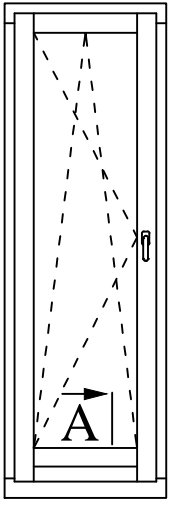

A

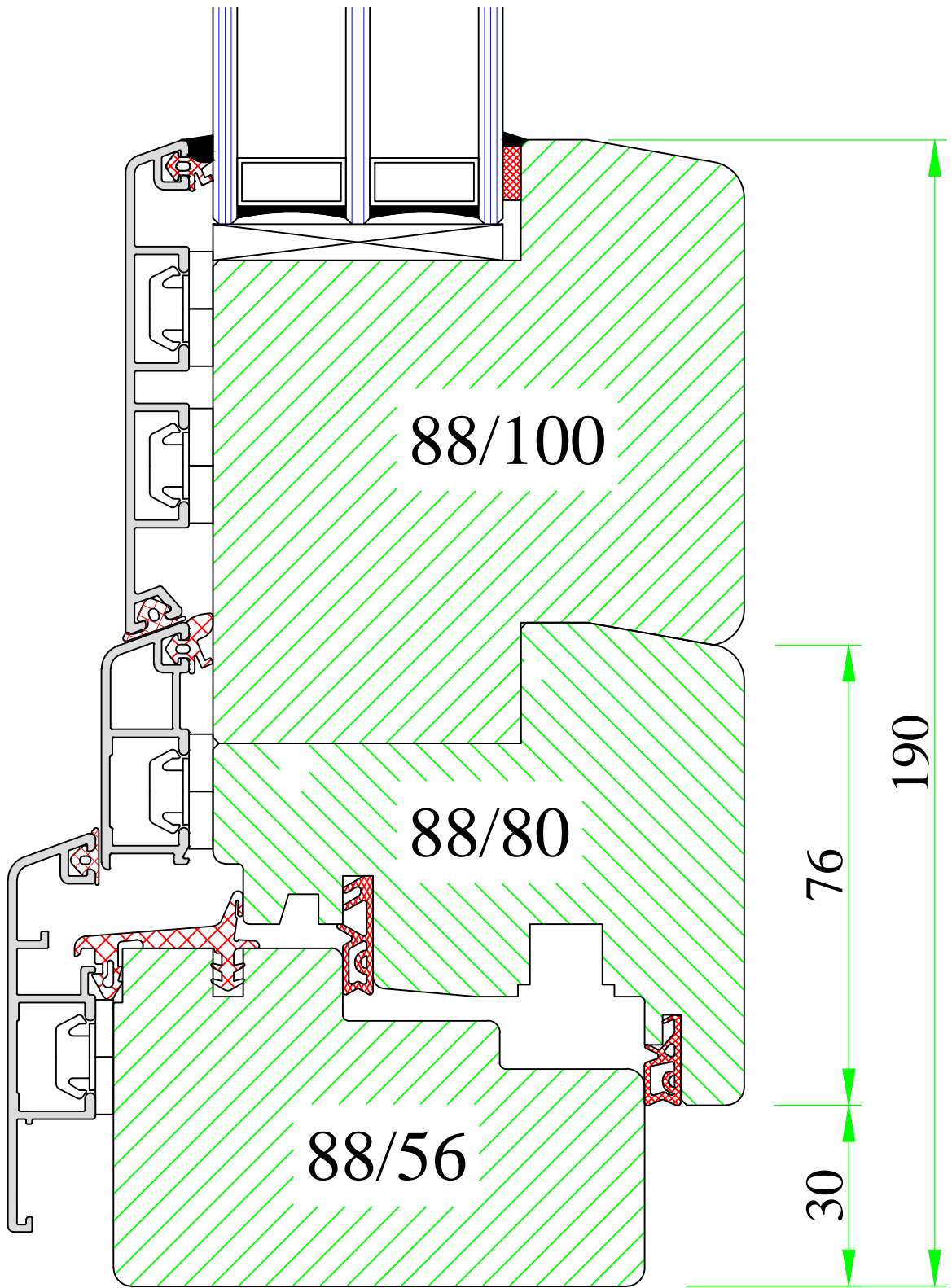

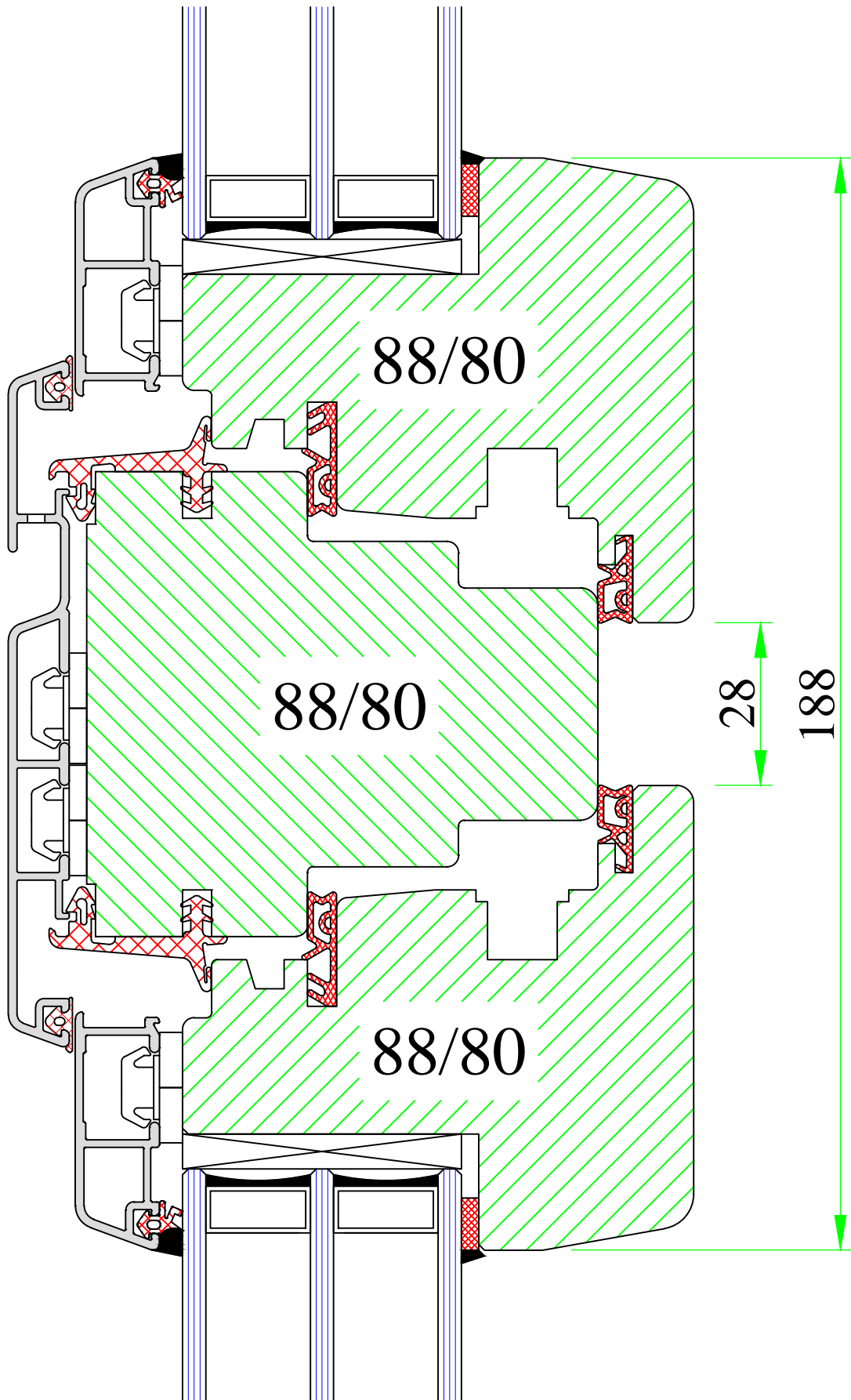
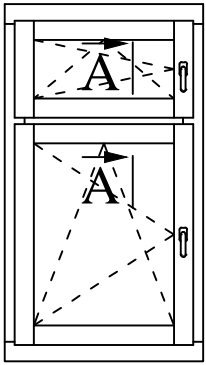

UNI WINDOWS Ltd.
 Unit 6, Edgefield Industrial Est.
 Loanhead, EH20 9TB
 Tel.: 0131 448 3931

THERMAX 1 / 2

Bottom and top sash – transom 80mm

Version: 1	Scale: 1:1
Date: 15.05.14	Drawing: NK/8

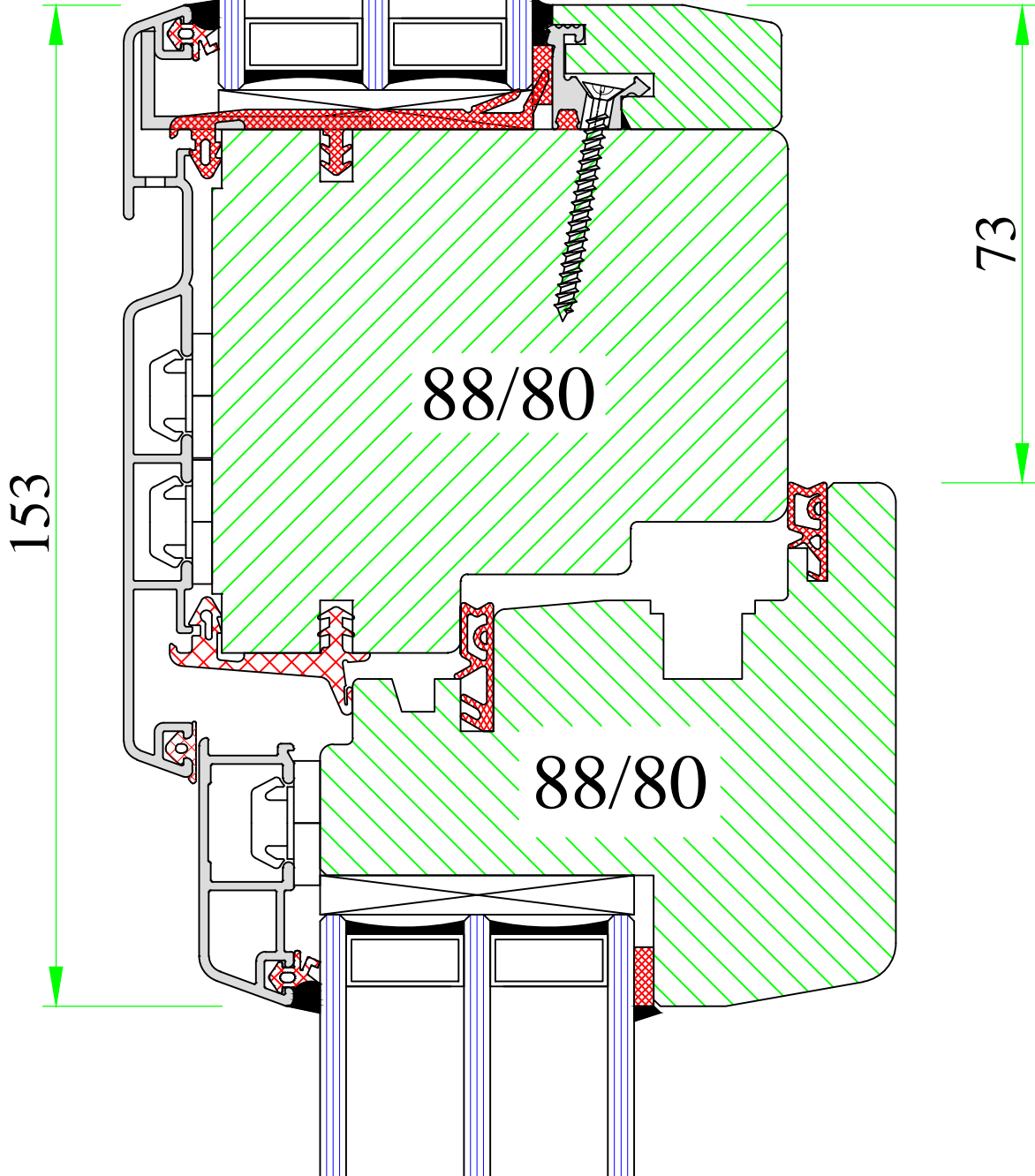
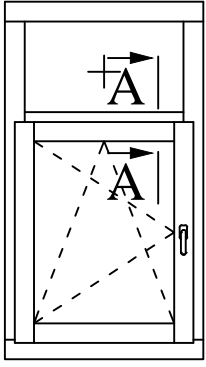

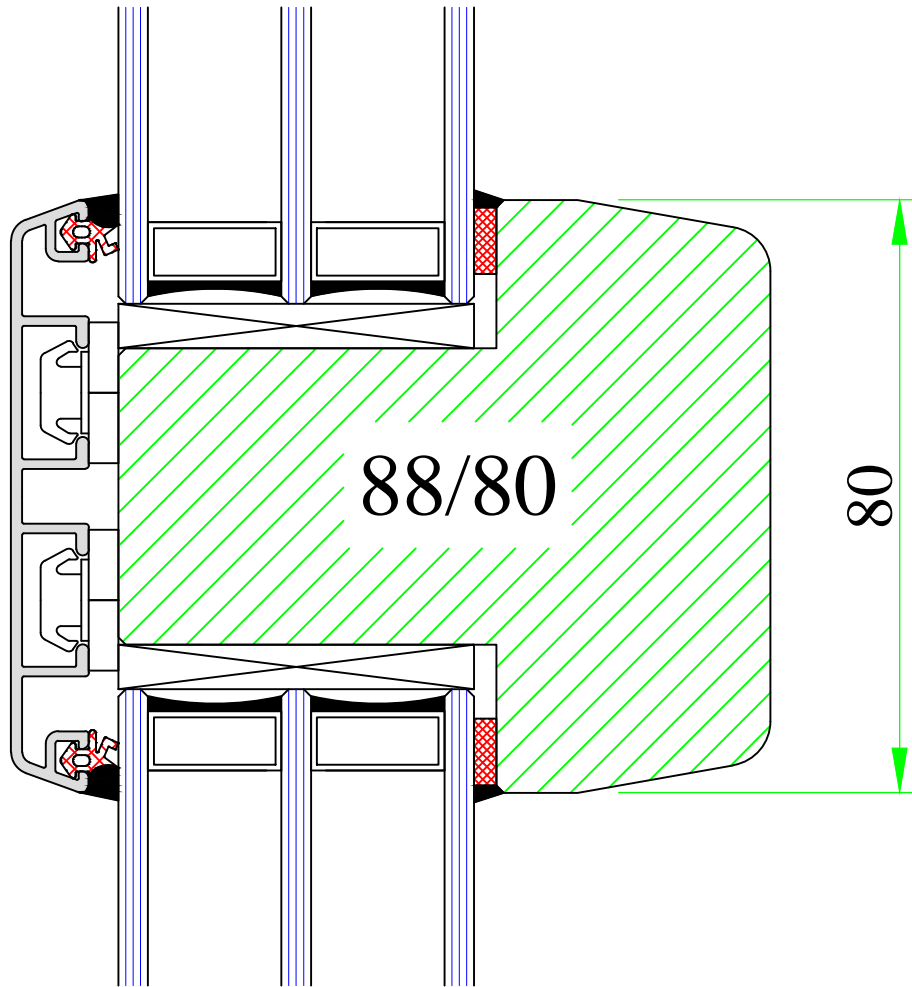
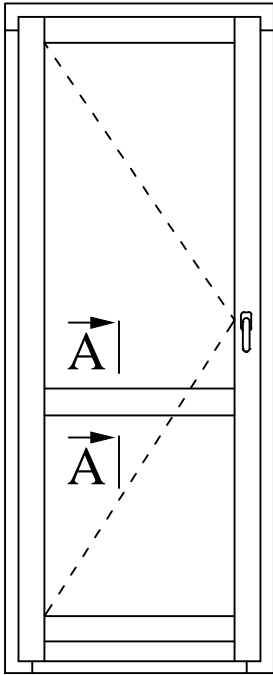

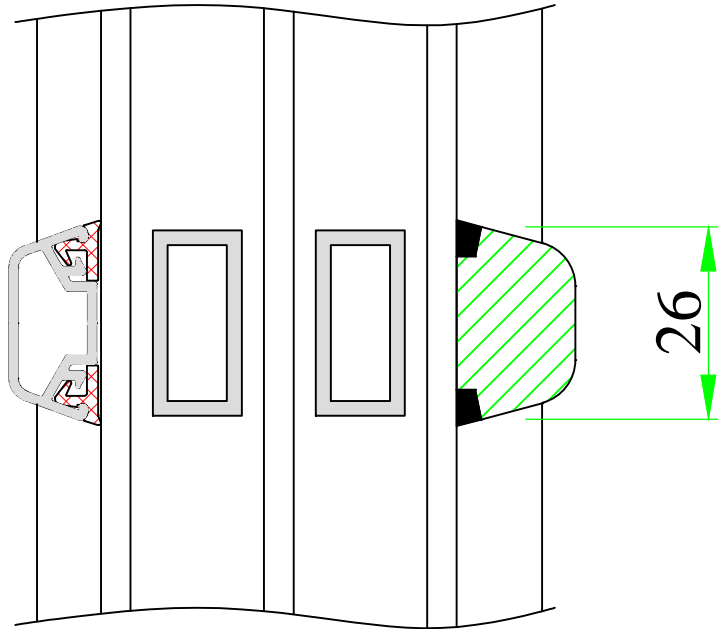
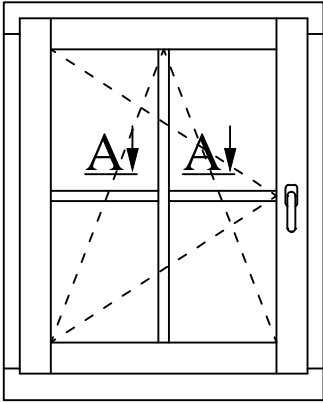

UNI WINDOWS Ltd.
 Unit 6, Edgefield Industrial Est.
 Loanhead, EH20 9TB
 Tel.: 0131 448 3931

Georgian bar 26mm

THERMAX 1 / 2

Version:
1

Scale:
1:1

Date:
15.05.14

Drawing:
NK/16

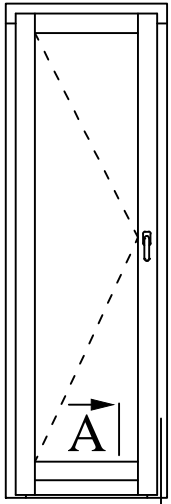

A

(out)

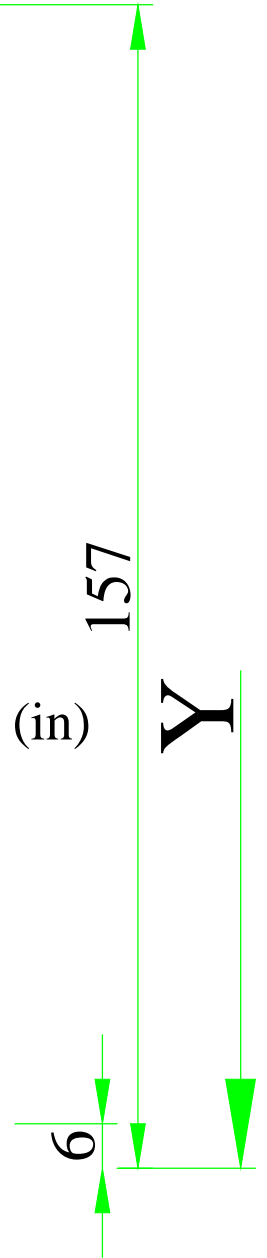
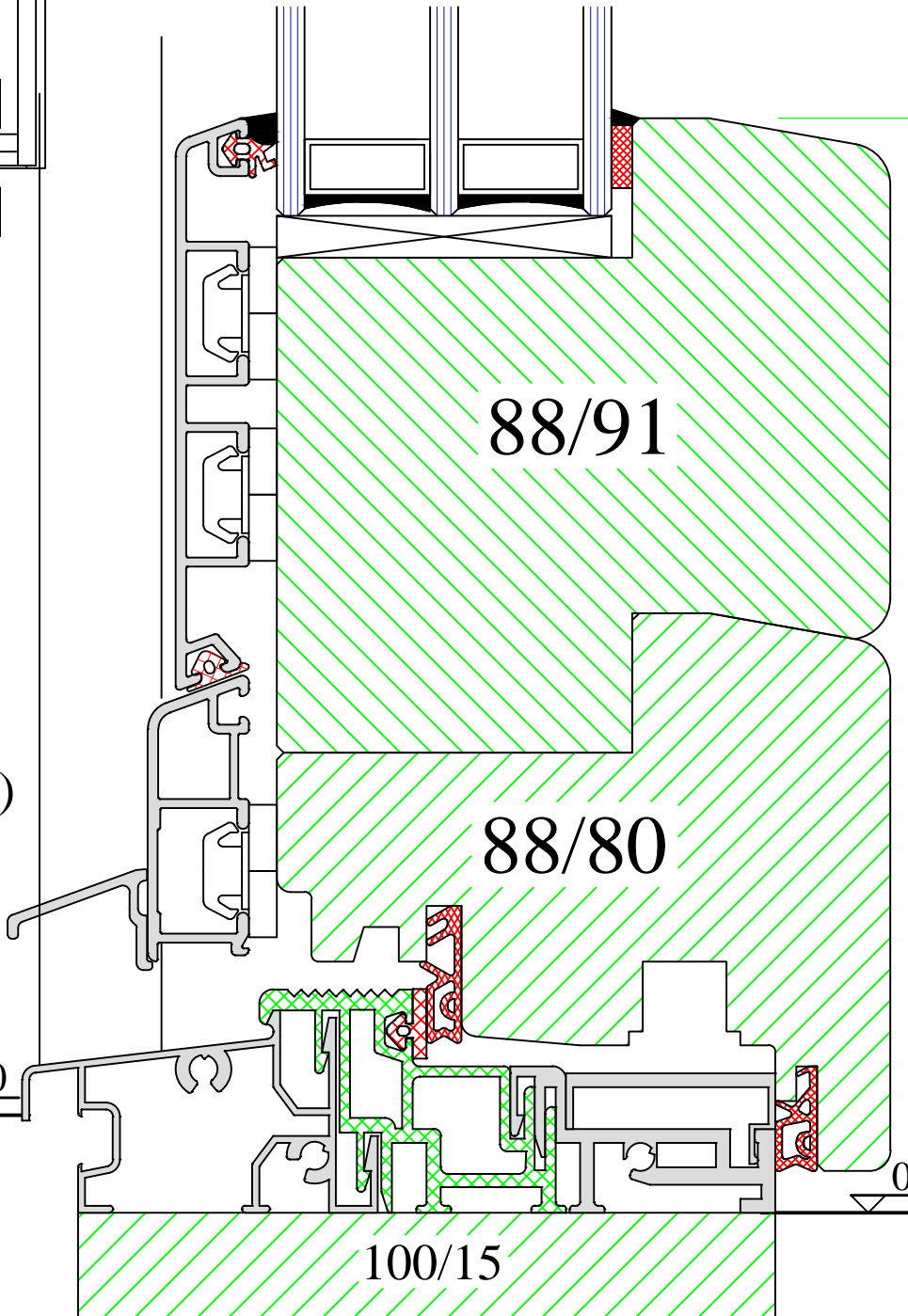

www.uniwin.co.uk



UNI WINDOWS Ltd.
 Unit 6, Edgefield Industrial Est.
 Loanhead, EH20 9TB
 Tel.: 0131 448 3931

THERMAX 1 / 2

Balcony door with flat threshold Weser

Version:
1

Date:
15.05.14

Scale:
1:1

Drawing:
NK/18

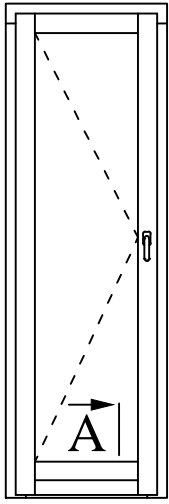

A

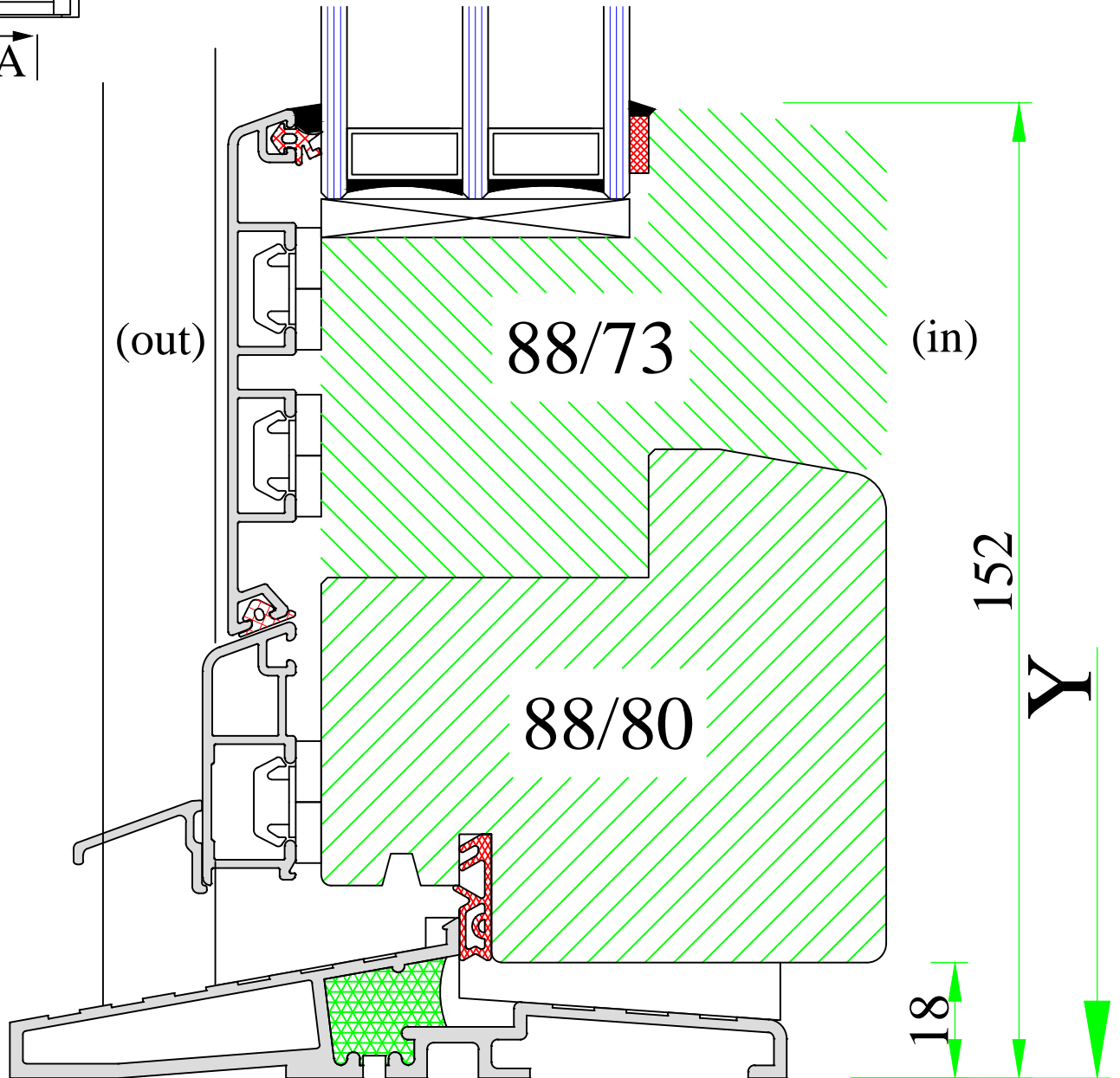

www.uniwin.co.uk



UNI WINDOWS Ltd.
 Unit 6, Edgefield Industrial Est.
 Loanhead, EH20 9TB
 Tel.: 0131 448 3931

THERMAX 1 / 2

Balcony door with flat threshold DAFA

Version:
1

Date:
15.05.14

Scale:
1:1

Drawing:
NK/19

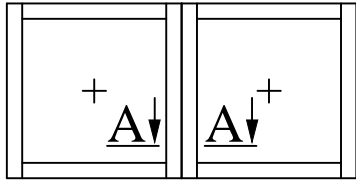

40

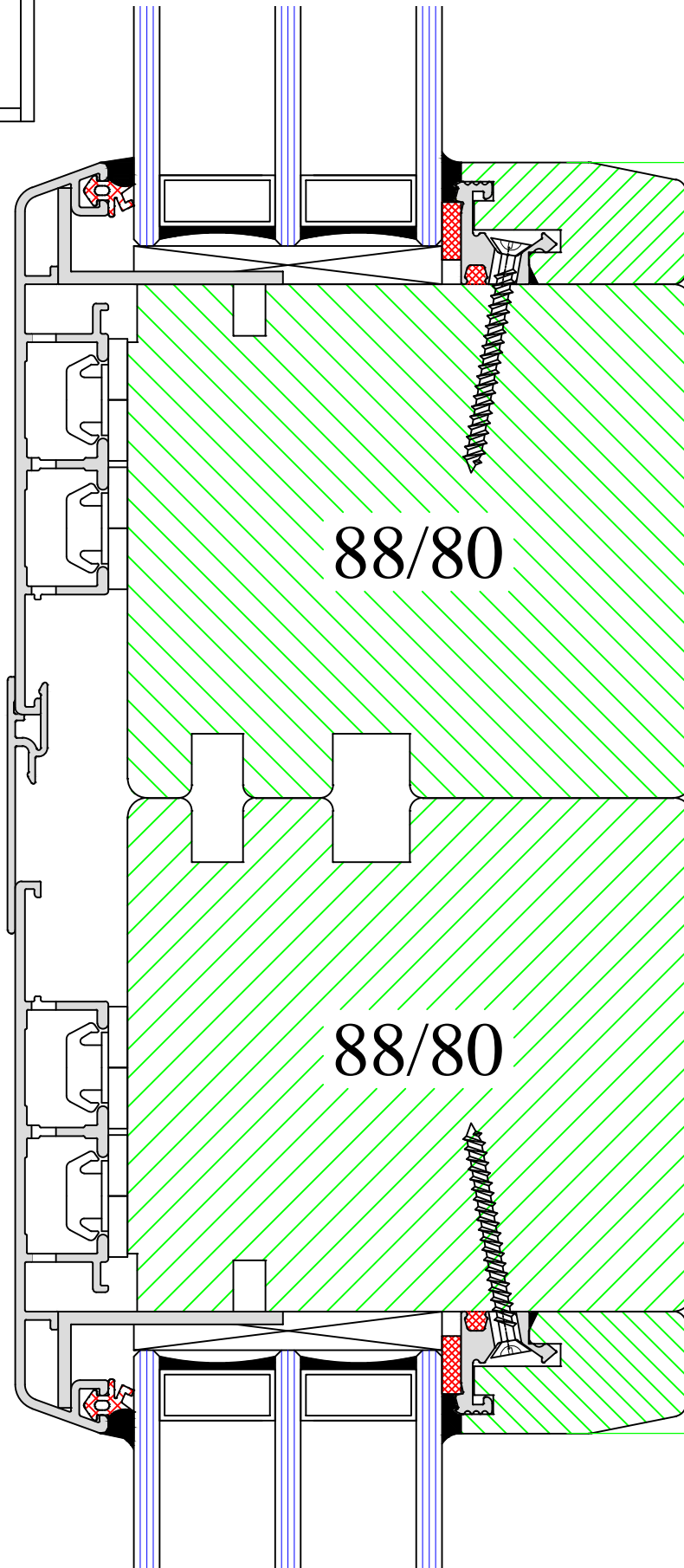

198

www.uniwin.co.uk



UNI WINDOWS Ltd.
 Unit 6, Edgefield Industrial Est.
 Loanhead, EH20 9TB
 Tel.: 0131 448 3931

Sections connection - vertical

THERMAX

Version:
1

Scale:
1:1

Date:
15.05.14

Drawing:
NK/20

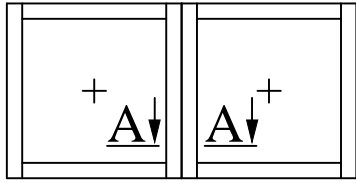

20

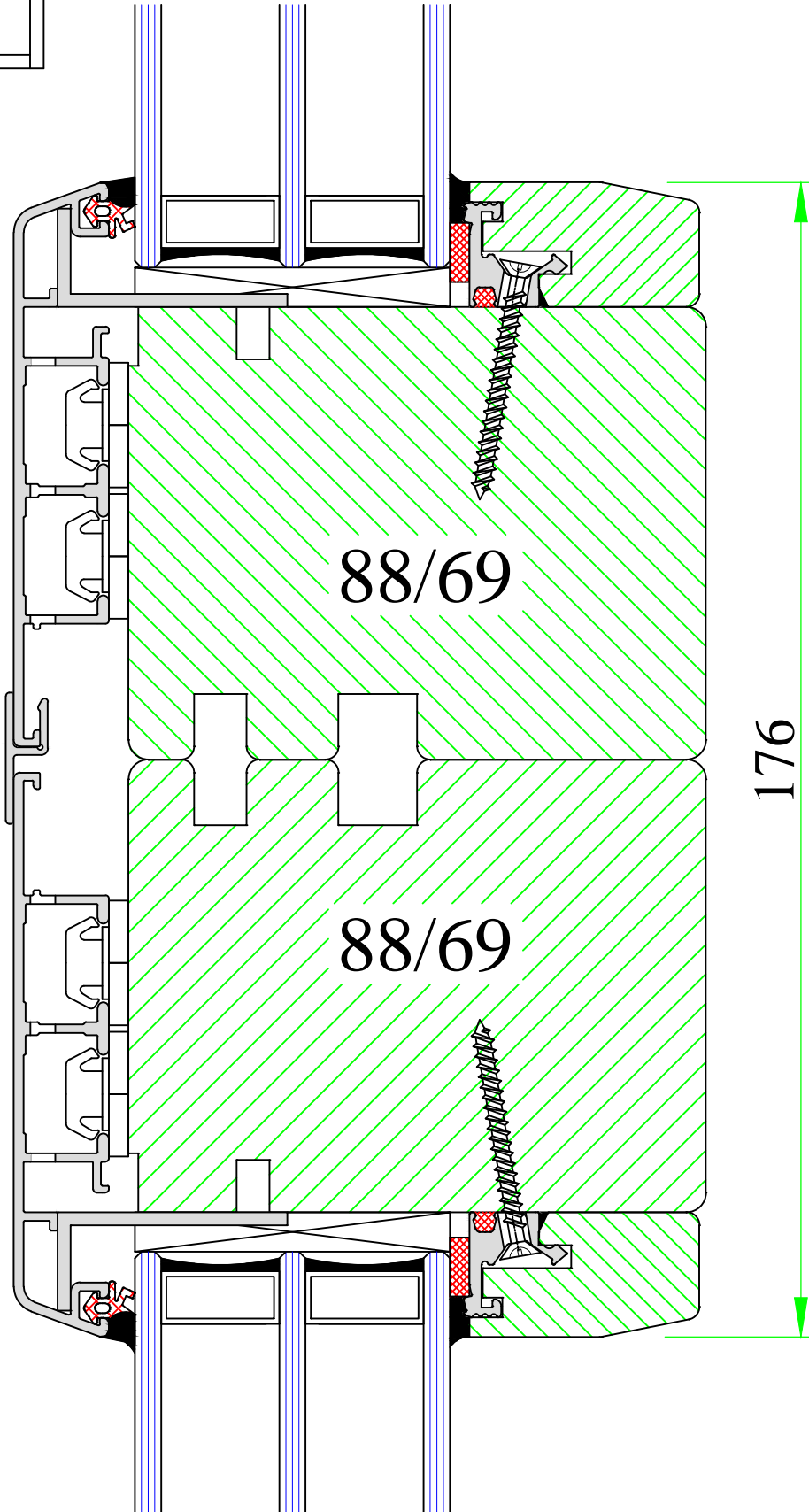

176



UNI WINDOWS Ltd.
 Unit 6, Edgefield Industrial Est.
 Loanhead, EH20 9TB
 Tel.: 0131 448 3931

Sections connection – vertical

THERMAX 2

Version:
1

Scale:
1:1

Date:
15.05.14

Drawing:
NK2/20

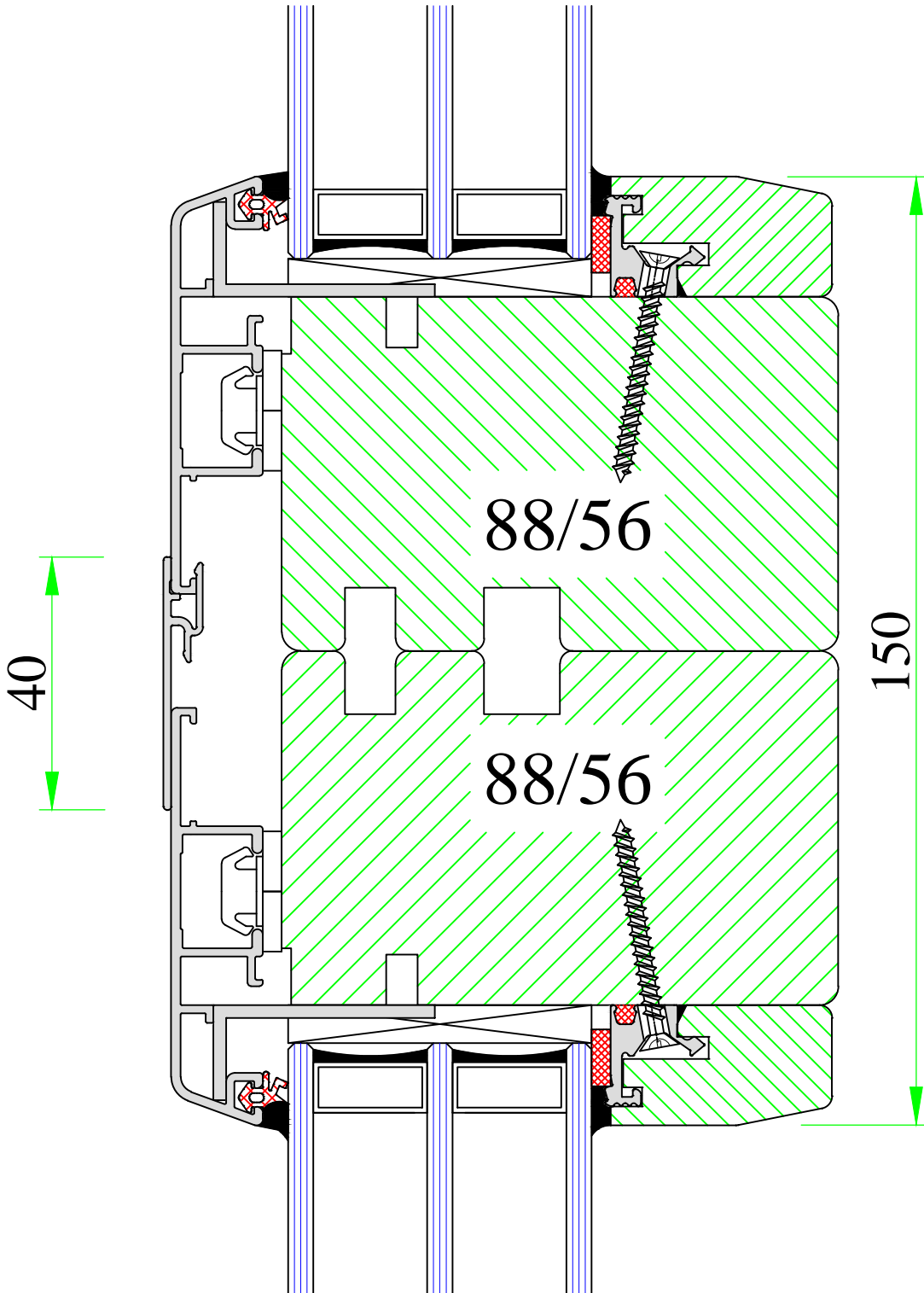
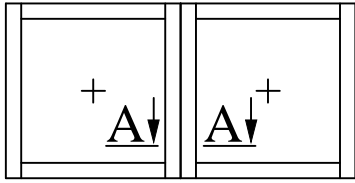

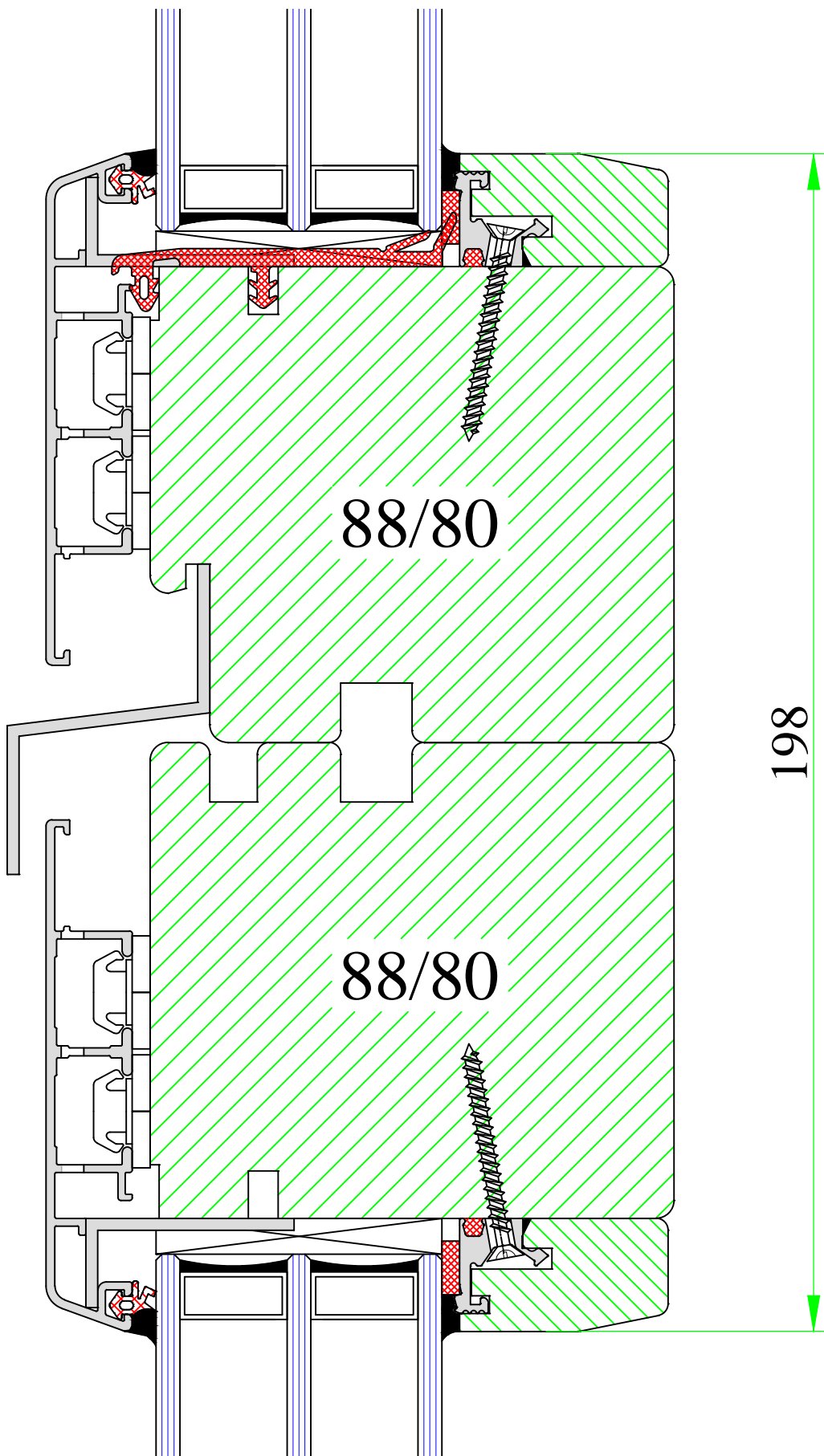
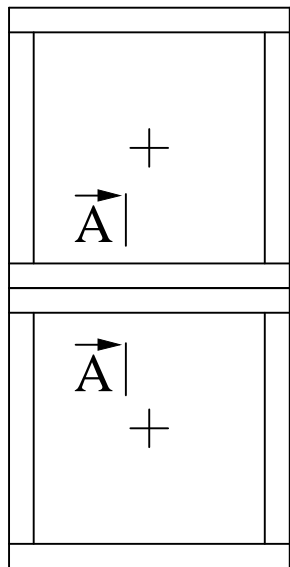

UNI WINDOWS Ltd.
 Unit 6, Edgefield Industrial Est.
 Loanhead, EH20 9TB
 Tel.: 0131 448 3931

Sections connection - horizontal

THERMAX

Version:
1

Scale:
1:1

Date:
15.05.14

Drawing:
NK/20-1

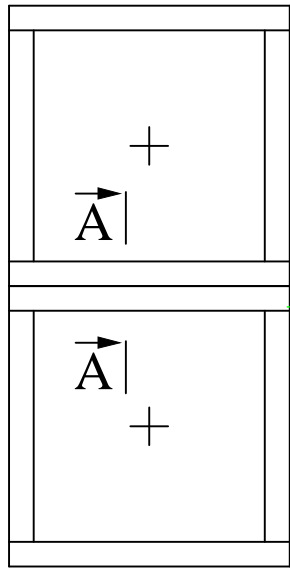

UNI WINDOWS Ltd.
 Unit 6, Edgefield Industrial Est.
 Loanhead, EH20 9TB
 Tel.: 0131 448 3931

THERMAX 2

Sections connection - horizontal

Version:
1

Scale:
1:1

Date:
15.05.14

Drawing:
NK2/20-1

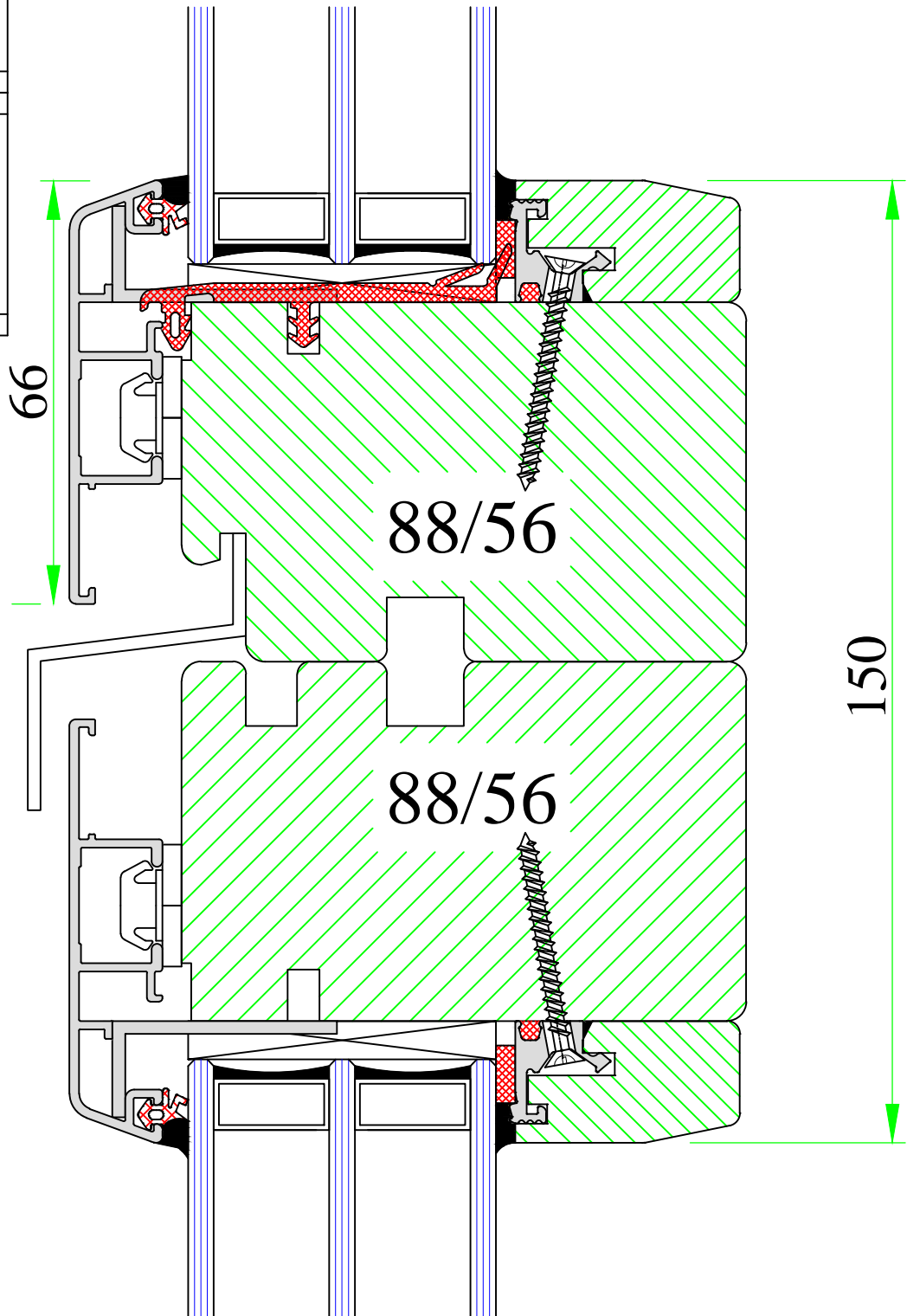
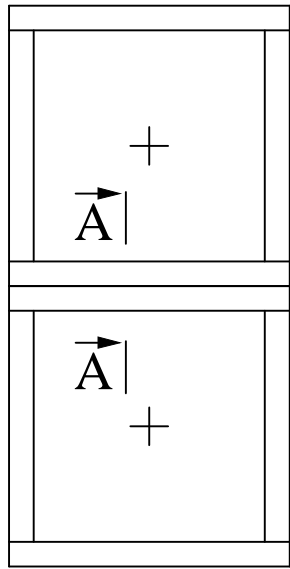

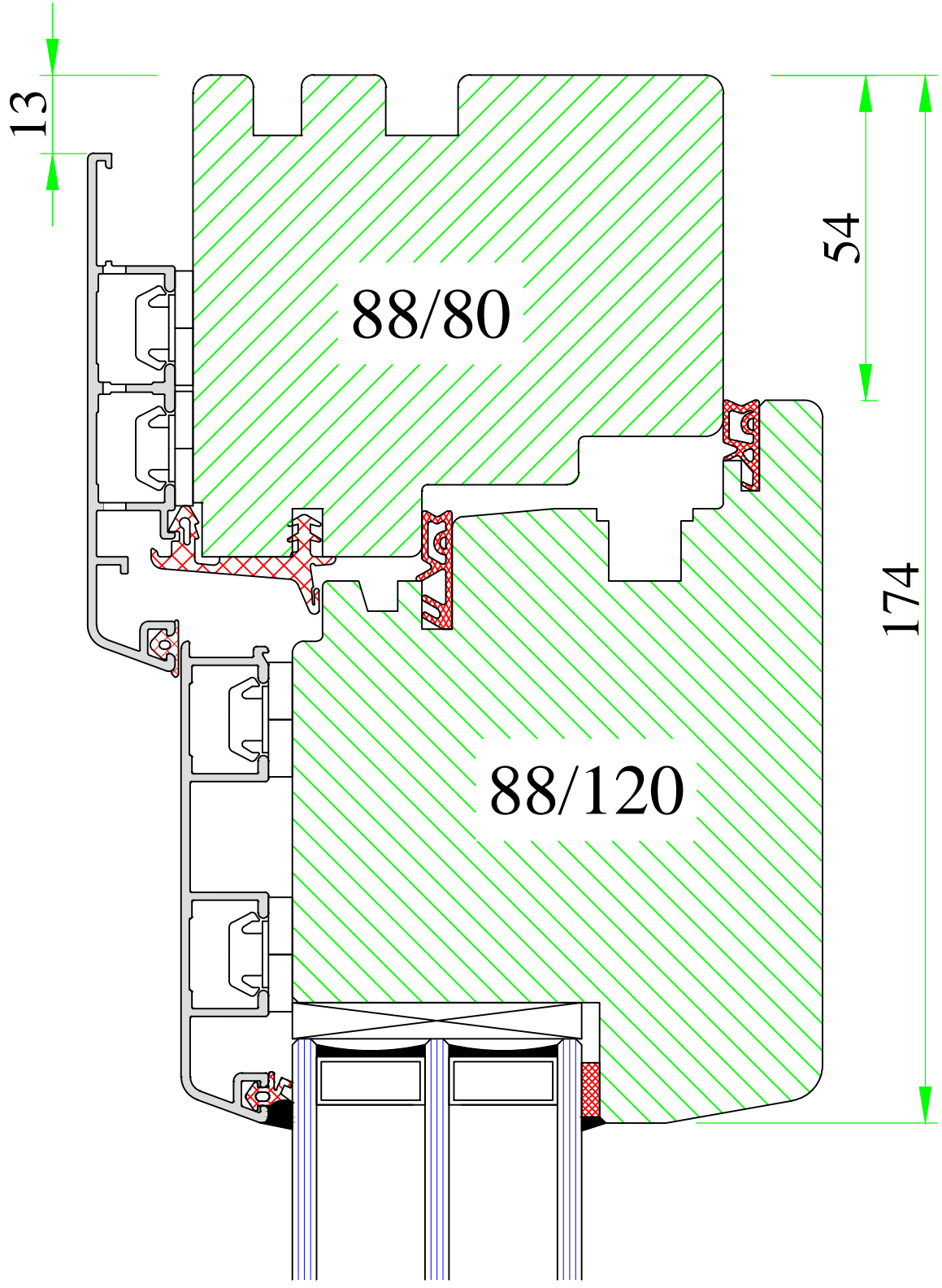
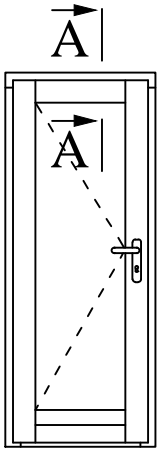

www.uniwin.co.uk



UNI WINDOWS Ltd.
 Unit 6, Edgefield Industrial Est.
 Loanhead, EH20 9TB
 Tel.: 0131 448 3931

THERMAX

Frame-sash door connection – top and sides

Version: 1	Scale: 1:1
Date: 15.05.14	Drawing: NK/21

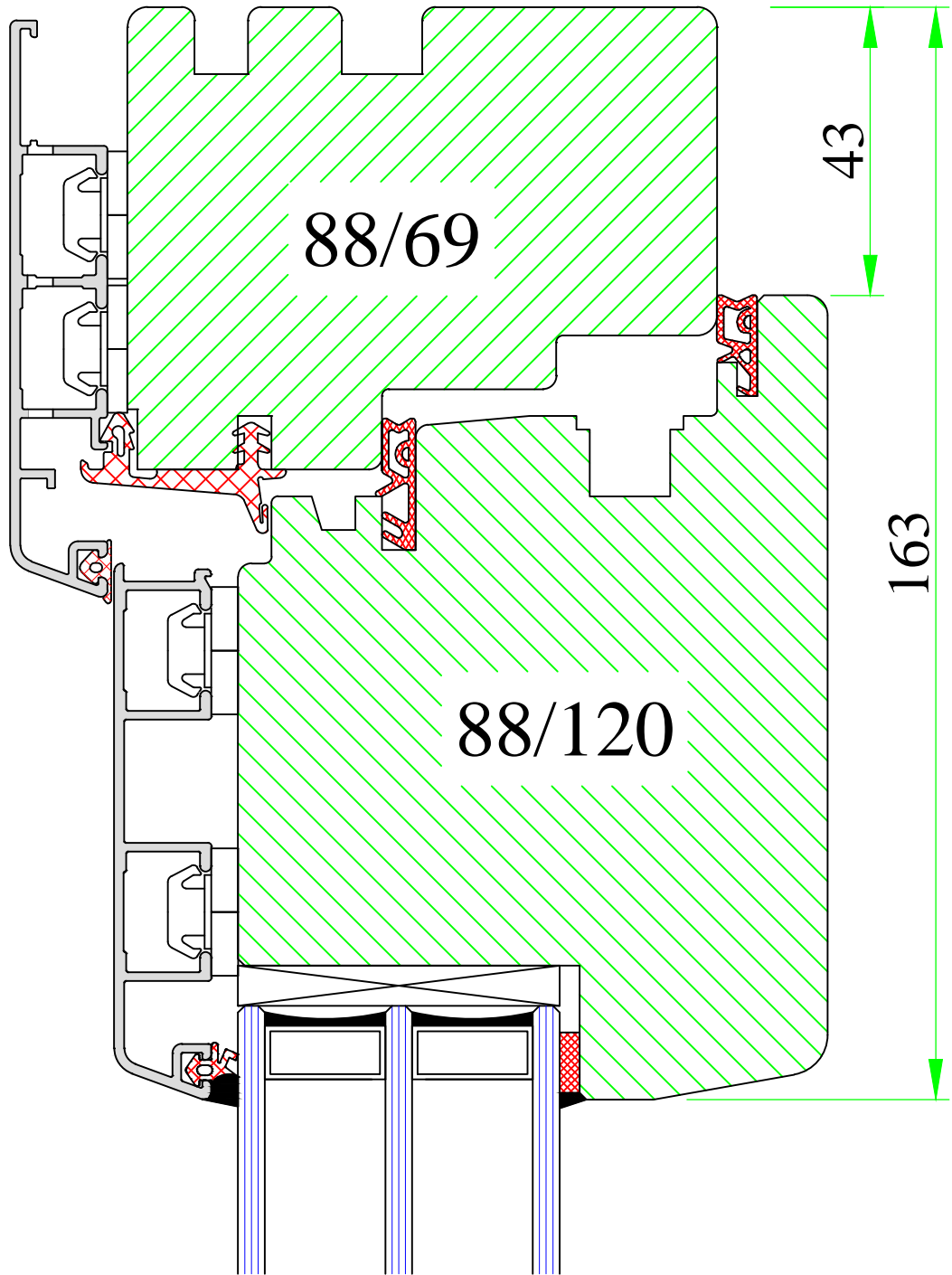
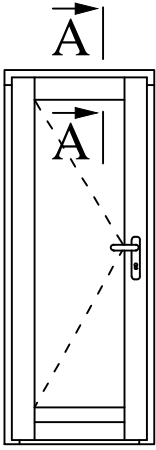

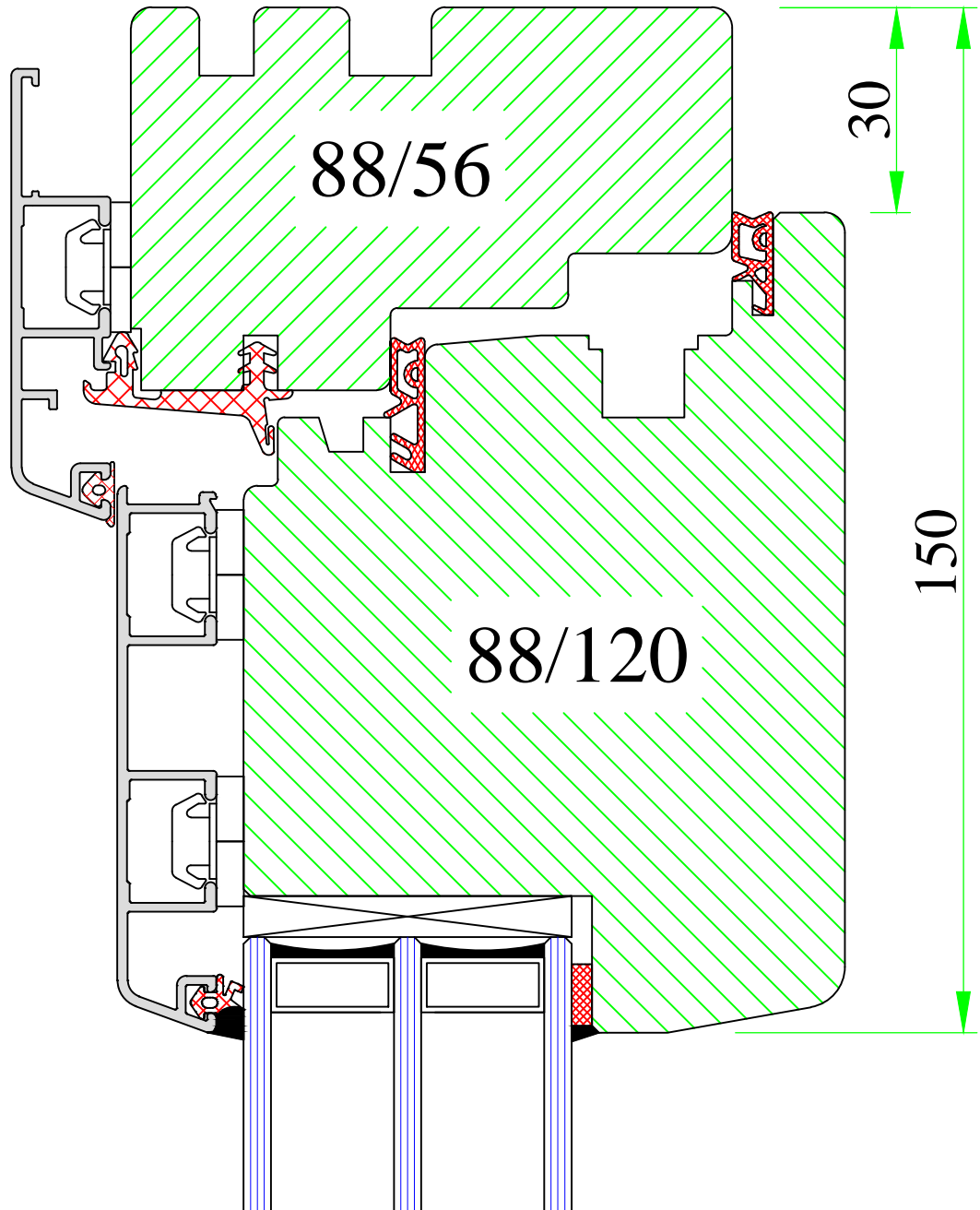
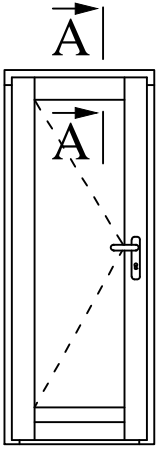

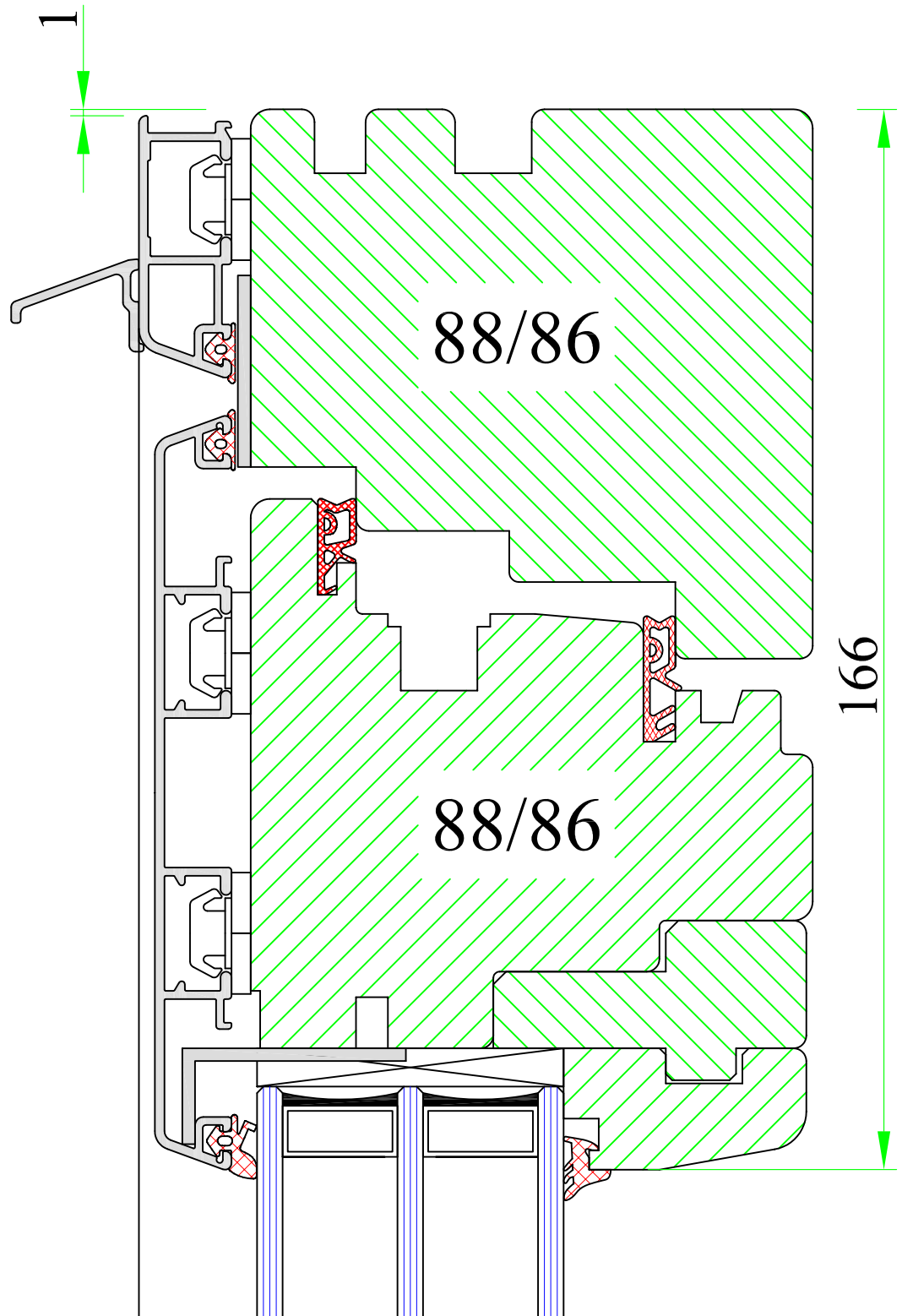
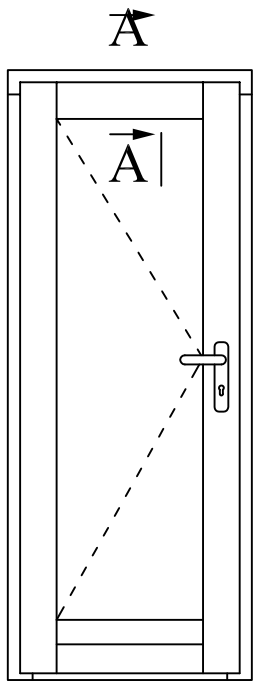

www.uniwin.co.uk



UNI WINDOWS Ltd.
 Unit 6, Edgefield Industrial Est.
 Loanhead, EH20 9TB
 Tel.: 0131 448 3931

THERMAX 1 / 2

Outward opening door – top and sides

Version: 1	Scale: 1:1
Date: 15.05.14	Drawing: NK/22

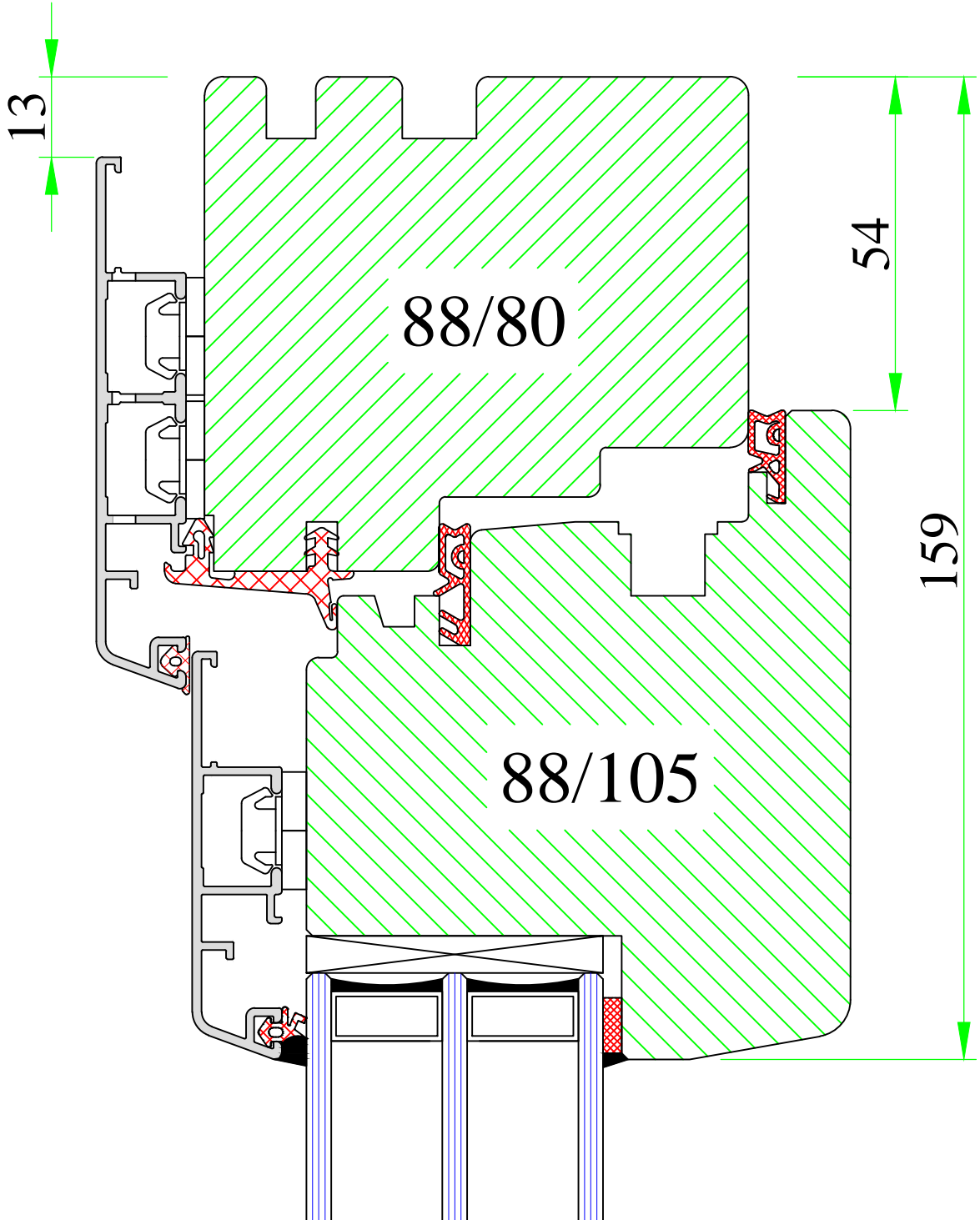
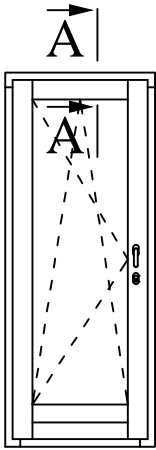

www.uniwin.co.uk



UNI WINDOWS Ltd.
 Unit 6, Edgefield Industrial Est.
 Loanhead, EH20 9TB
 Tel.: 0131 448 3931

THERMAX
 Frame-sash connection – top and sides

Version: 1	Scale: 1:1
Date: 15.05.14	Drawing: NK/23

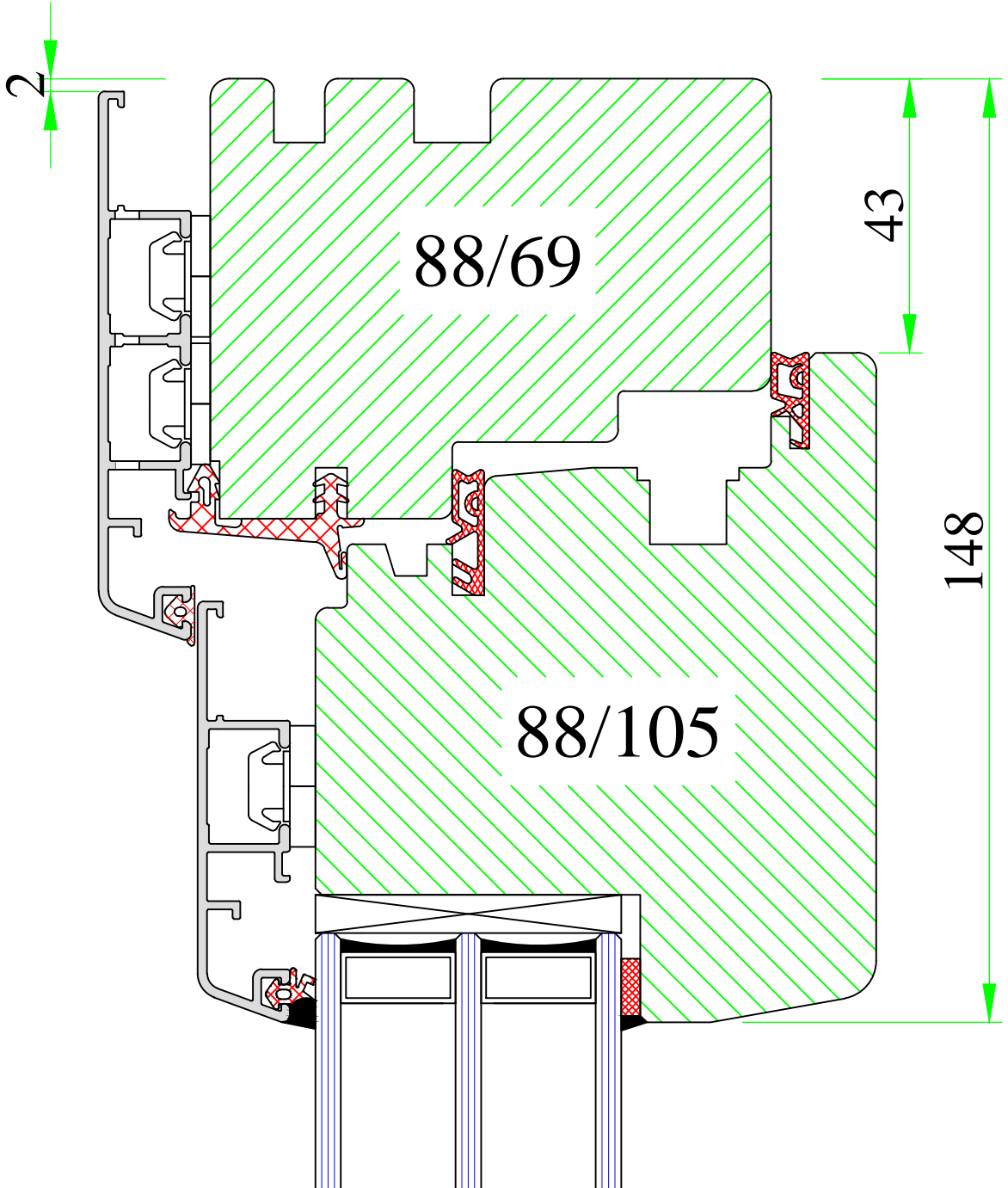
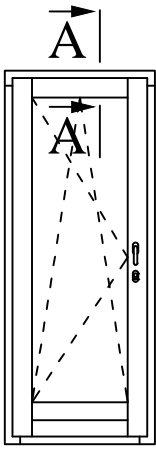

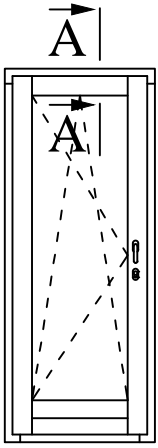

9

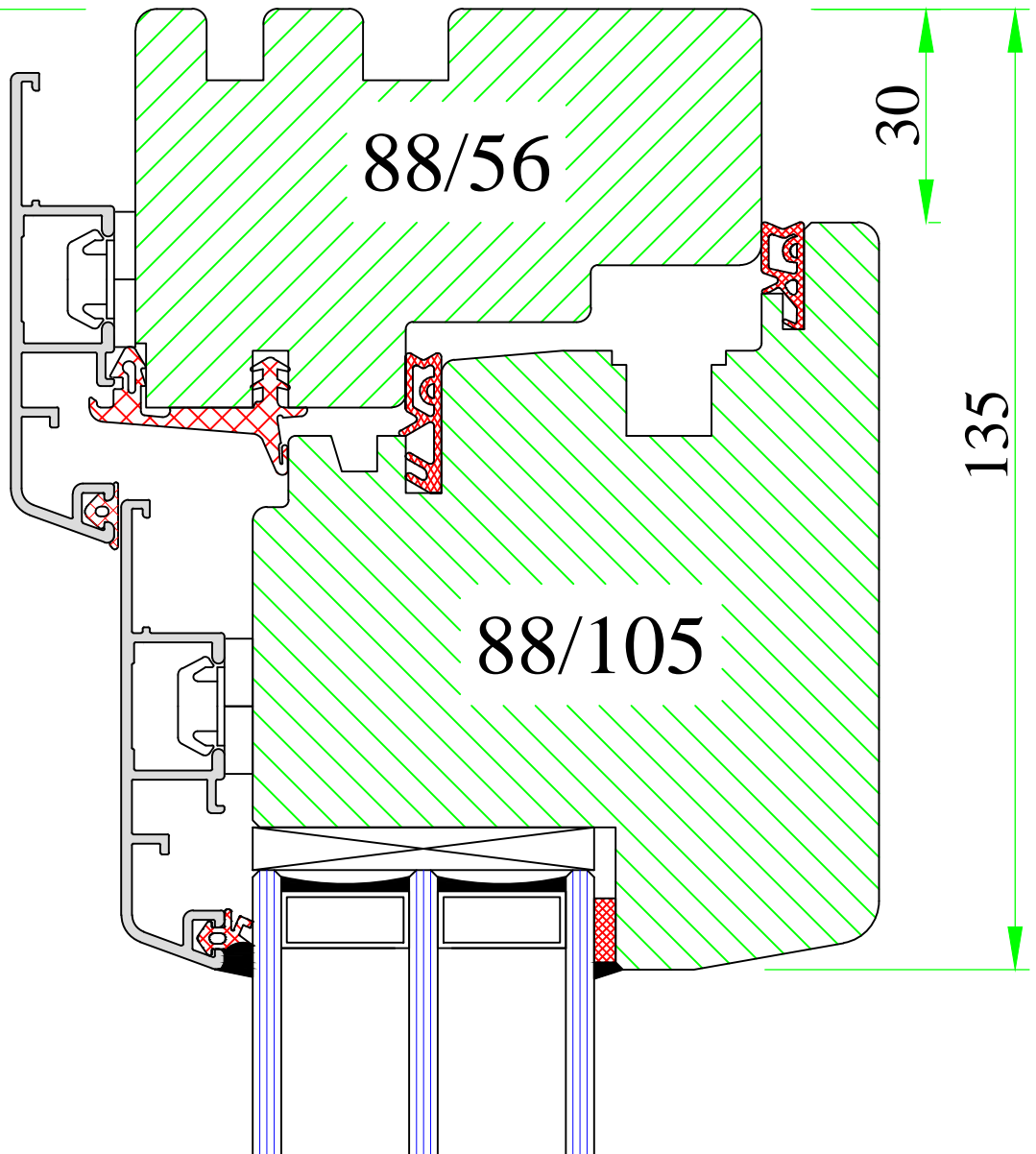

UNI WINDOWS Ltd.
 Unit 6, Edgefield Industrial Est.
 Loanhead, EH20 9TB
 Tel.: 0131 448 3931

THERMAX 3

Frame-sash connection – top and sides

Version:
1

Date:
15.05.14

Scale:
1:1

Drawing:
NK3/23

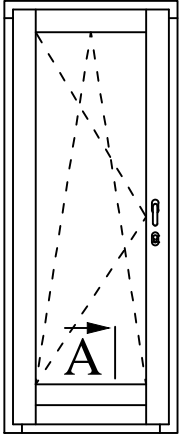

A

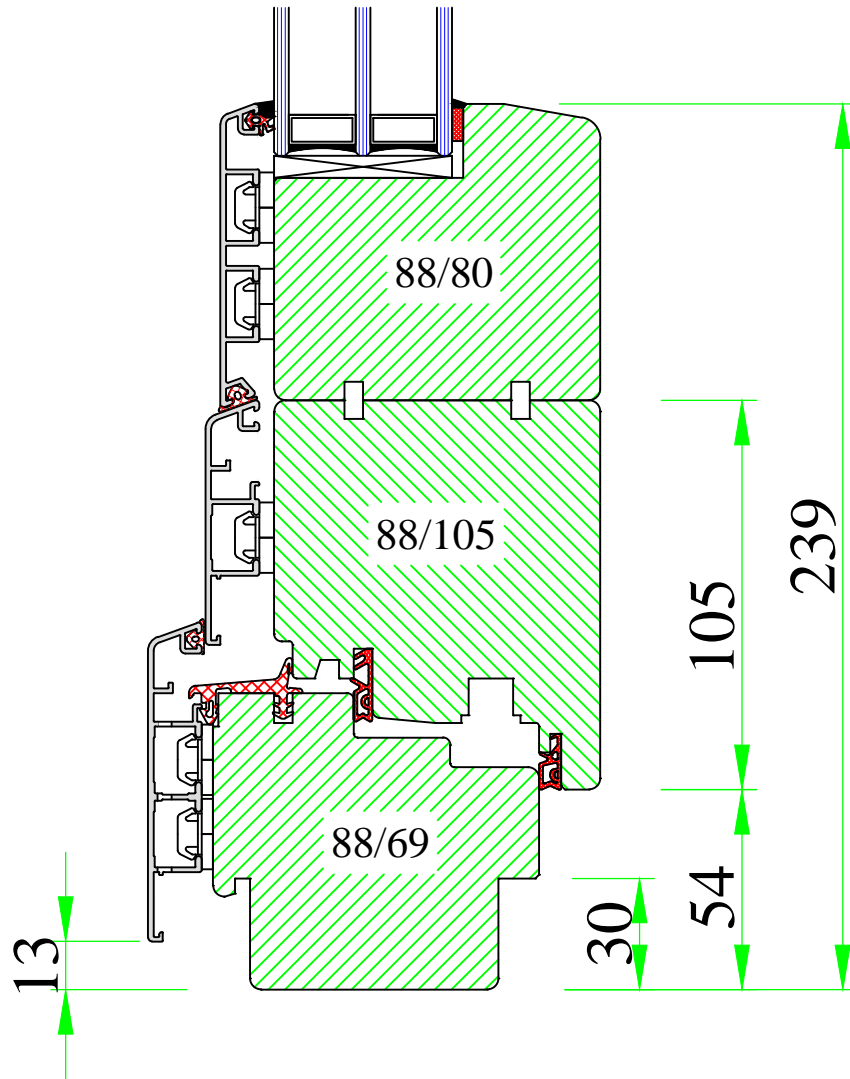

UNI WINDOWS Ltd.
 Unit 6, Edgefield Industrial Est.
 Loanhead, EH20 9TB
 Tel.: 0131 448 3931

THERMAX
 Frame-sash connection – bottom of balcony door

Version: 1	Scale: 1:2
Date: 15.05.14	Drawing: NK/24

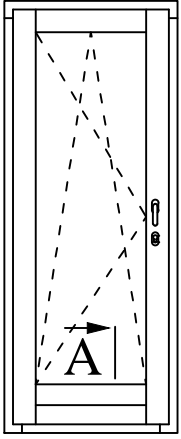

A

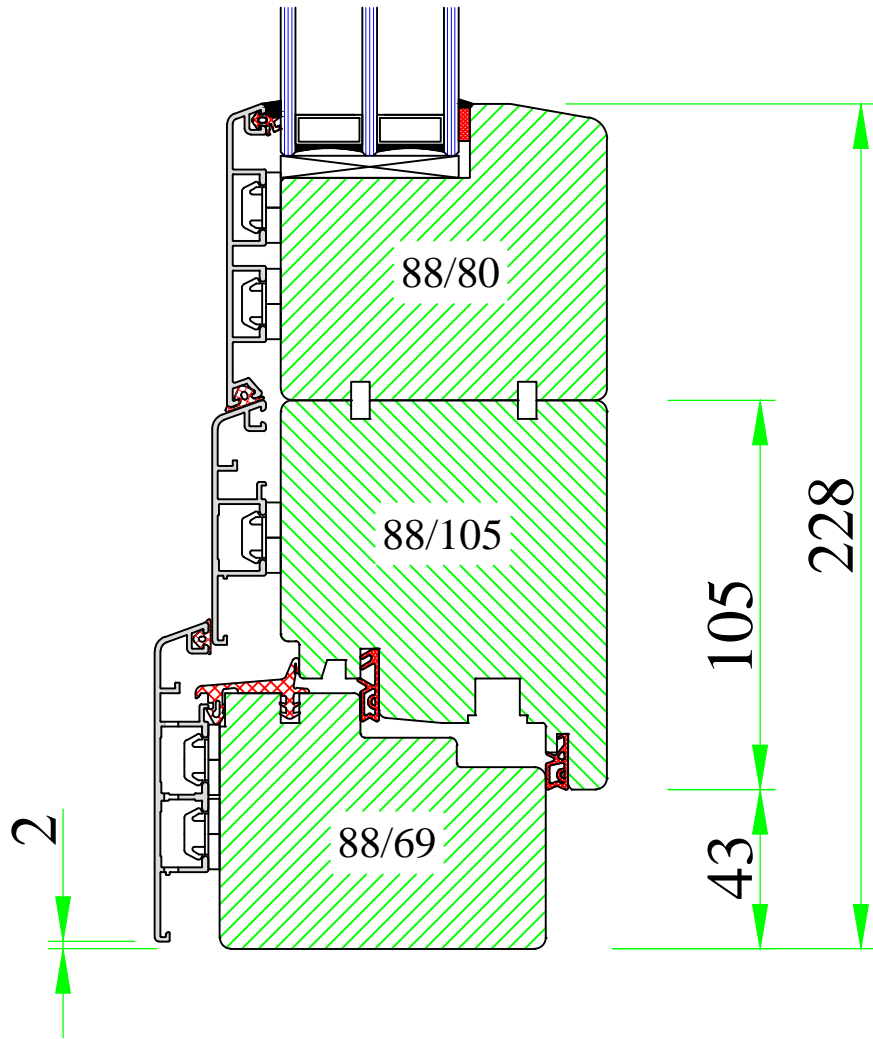

UNI WINDOWS Ltd.
 Unit 6, Edgefield Industrial Est.
 Loanhead, EH20 9TB
 Tel.: 0131 448 3931

THERMAX 2
 Frame-sash connection – bottom of balcony door

Version: 1	Scale: 1:2
Date: 15.05.14	Drawing: NK2/24

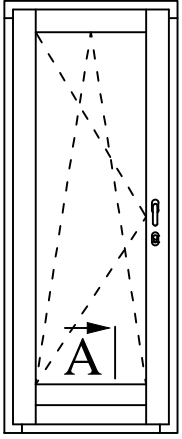

A

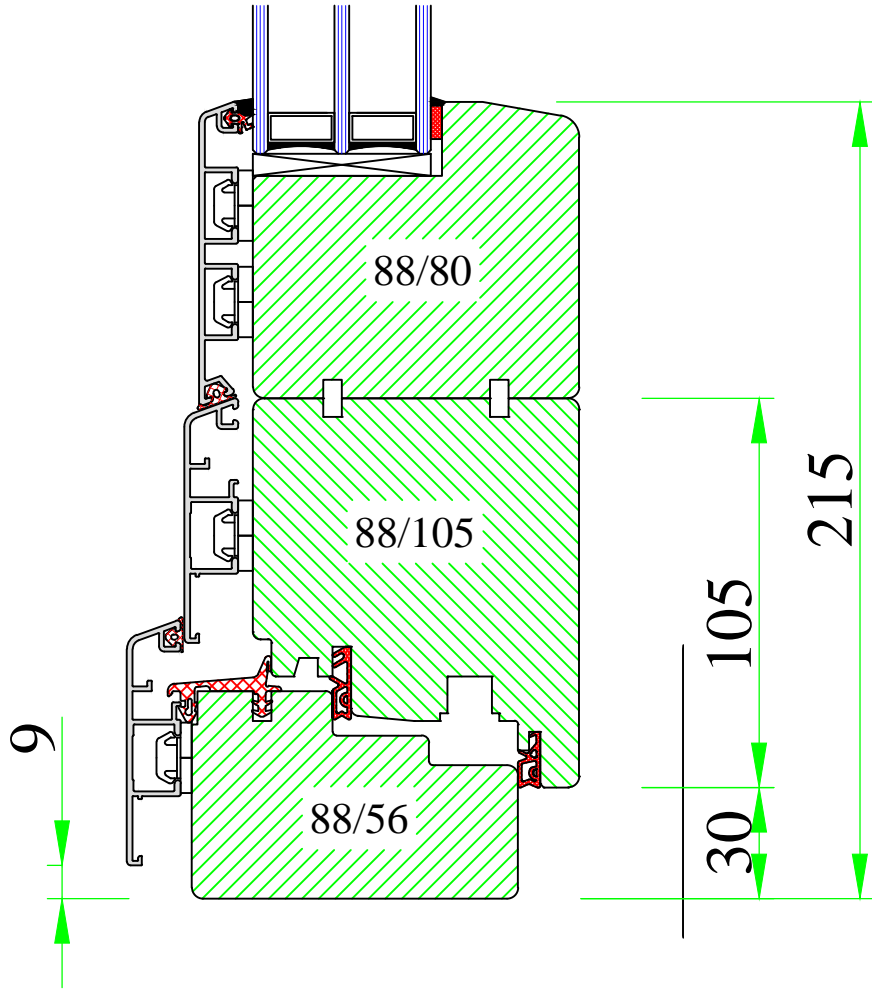

UNI WINDOWS Ltd.
 Unit 6, Edgefield Industrial Est.
 Loanhead, EH20 9TB
 Tel.: 0131 448 3931

THERMAX 3
 Frame-sash connection – bottom of balcony door

Version: 1	Scale: 1:2
Date: 15.05.14	Drawing: NK3/24

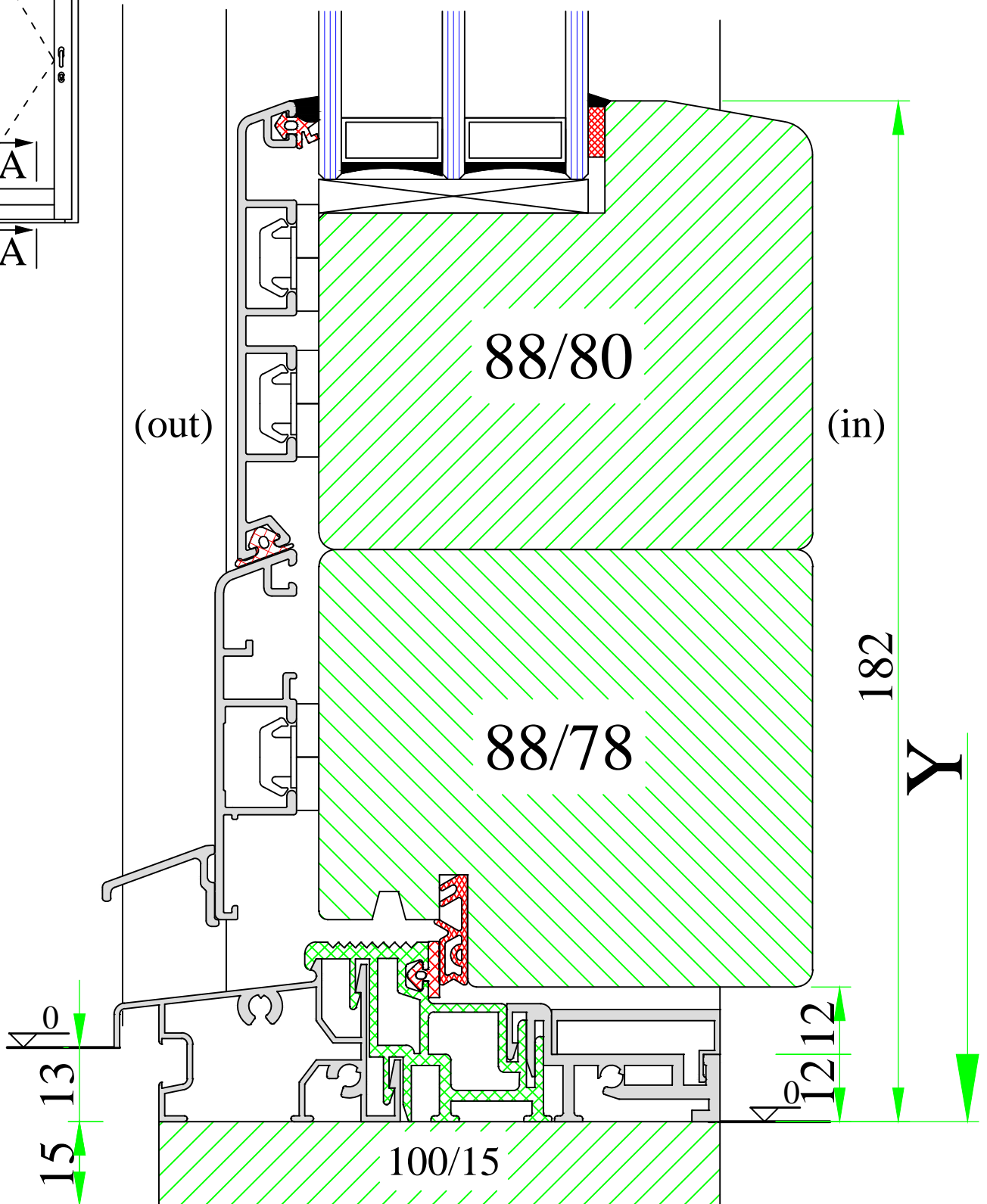
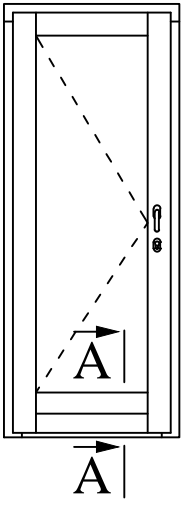

www.uniwin.co.uk



UNI WINDOWS Ltd.
 Unit 6, Edgefield Industrial Est.
 Loanhead, EH20 9TB
 Tel.: 0131 448 3931

THERMAX 1 / 2

Balcony door with flat threshold Weser (new)

Version:
1

Date:
15.05.14

Scale:
1:1

Drawing:
NK/25

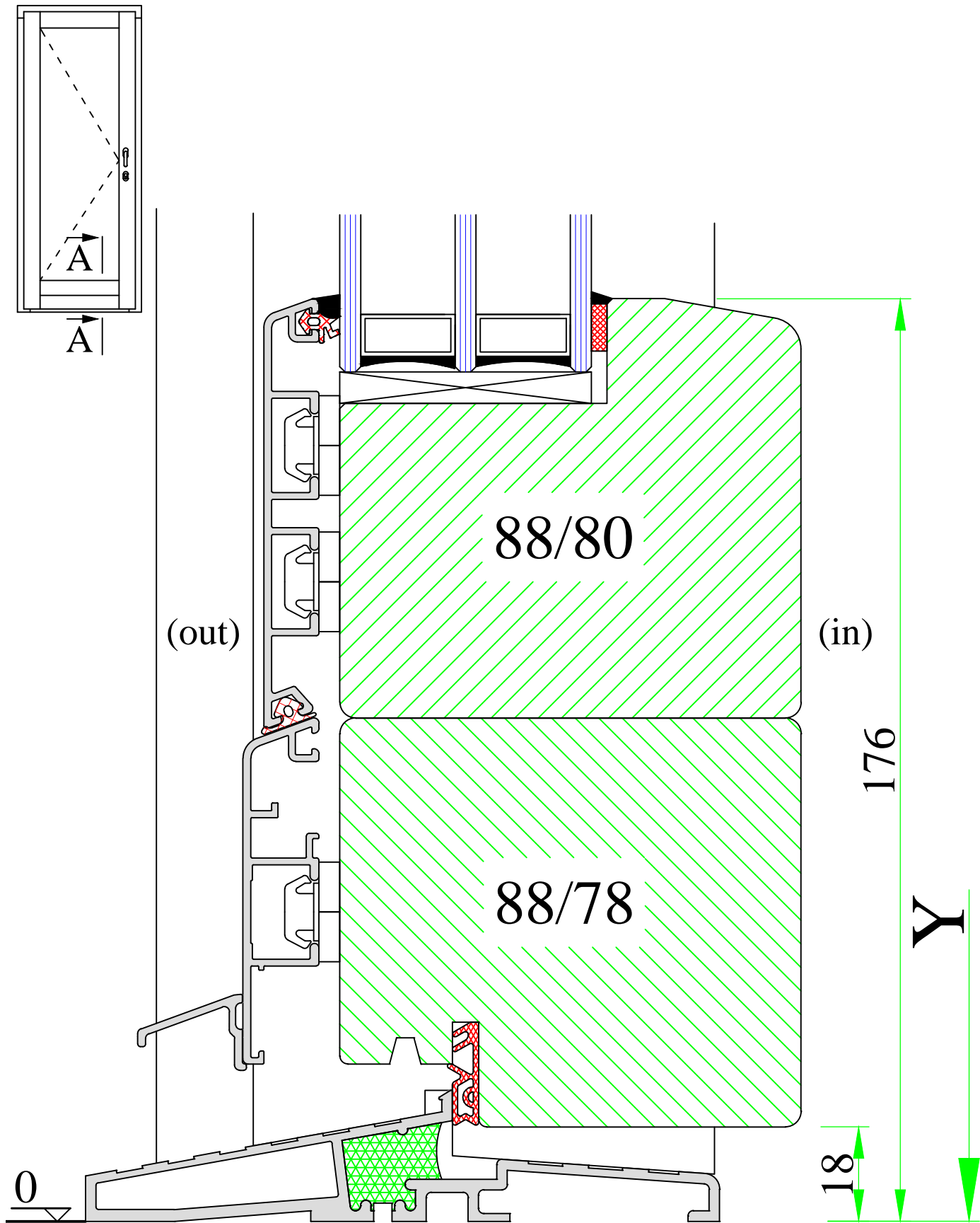

www.uniwin.co.uk



UNI WINDOWS Ltd.
 Unit 6, Edgefield Industrial Est.
 Loanhead, EH20 9TB
 Tel.: 0131 448 3931

THERMAX 1 / 2

Balcony door with flat threshold DAFA

Version: 1	Scale: 1:1
Date: 15.05.14	Drawing: NK/26

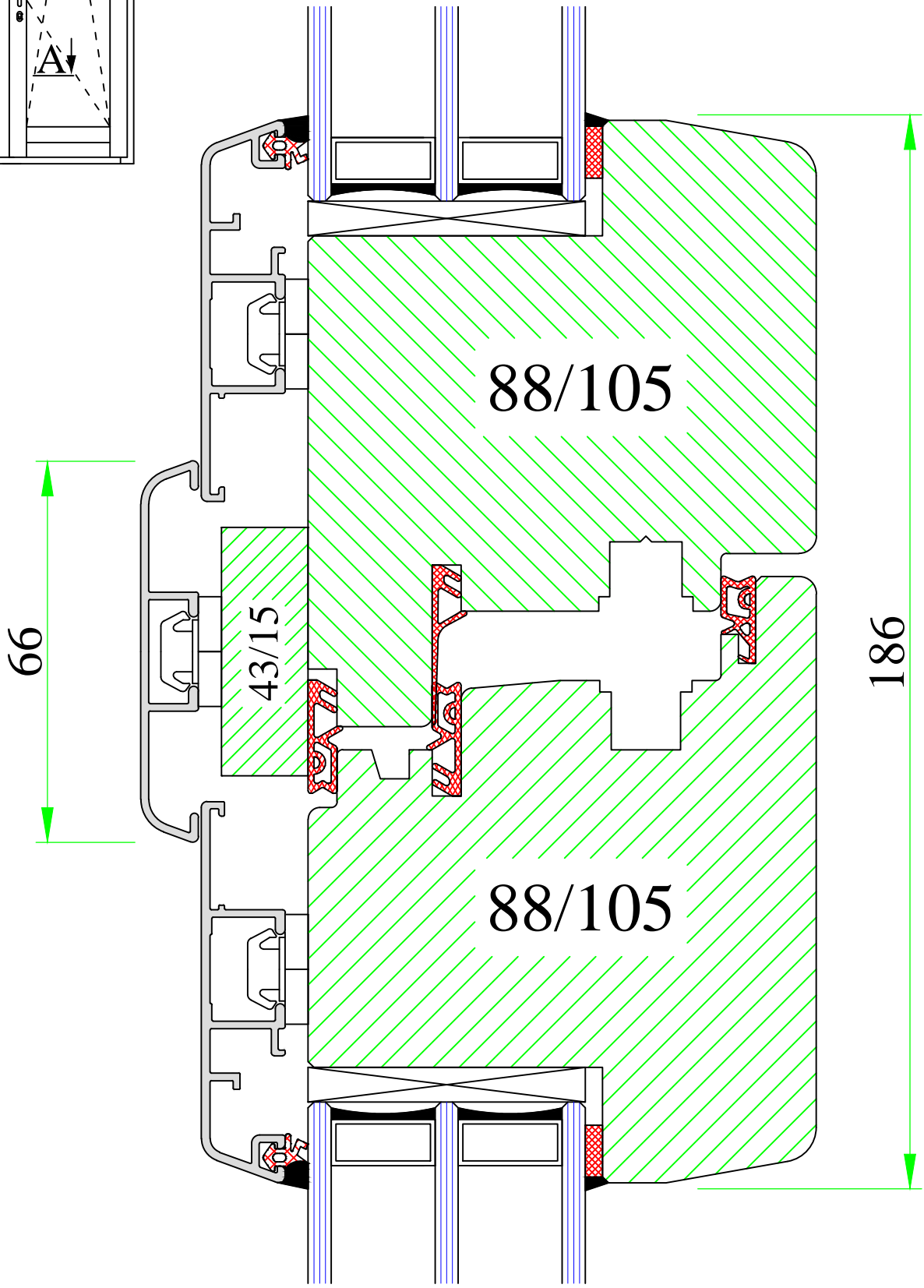
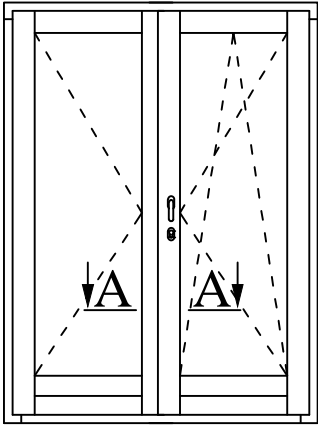

www.uniwin.co.uk



UNI WINDOWS Ltd.
 Unit 6, Edgefield Industrial Est.
 Loanhead, EH20 9TB
 Tel.: 0131 448 3931

THERMAX 1 / 2
 Balcony door - 'flying' mullion

Version: 1	Scale: 1:1
Date: 15.05.14	Drawing: NK/27

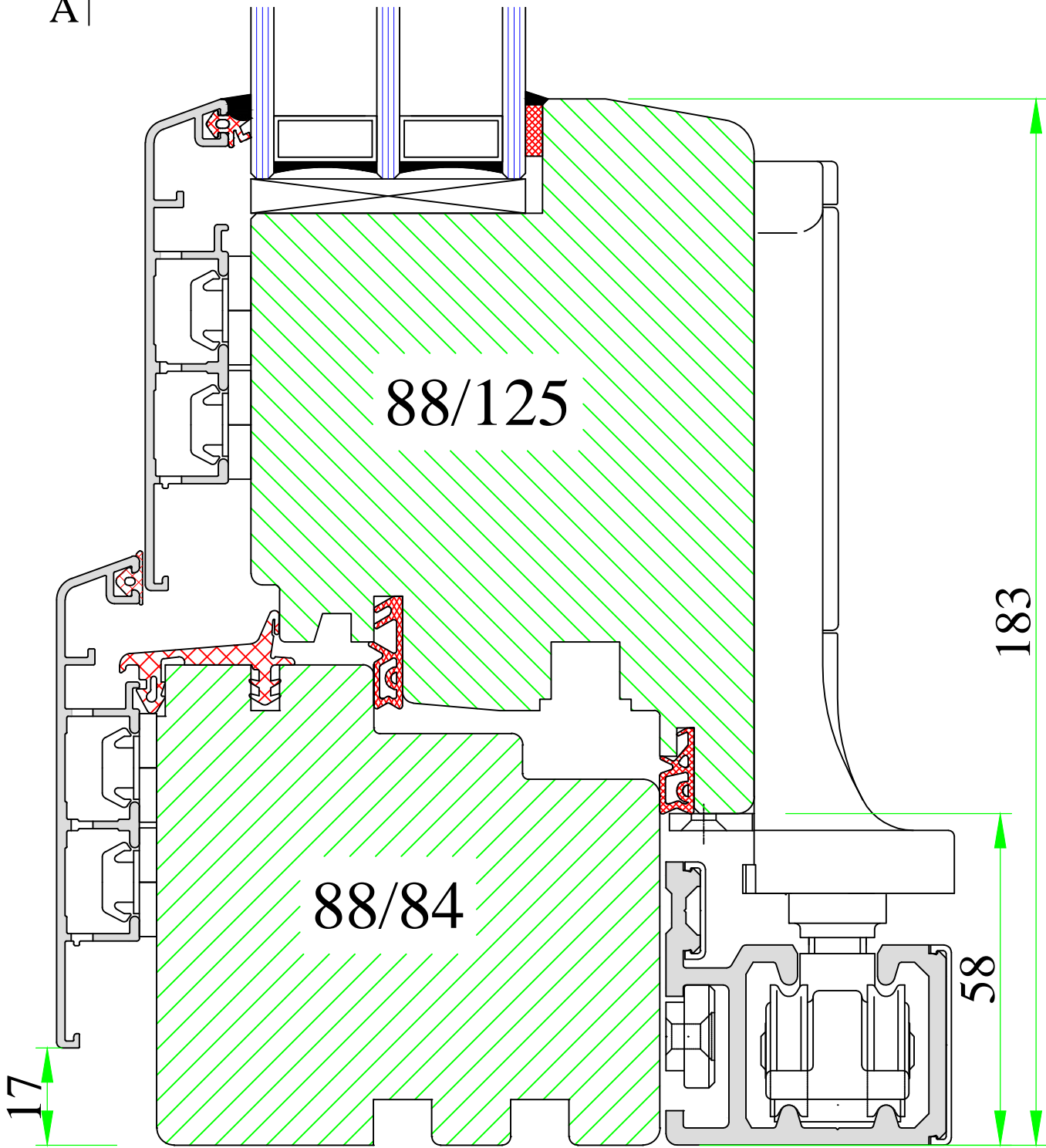
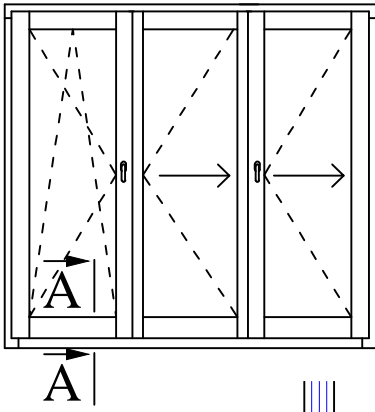

www.uniwin.co.uk



UNI WINDOWS Ltd.
 Unit 6, Edgefield Industrial Est.
 Loanhead, EH20 9TB
 Tel.: 0131 448 3931

THERMAX 1 / 2

Frame-sash connection – bottom of folding sliding door

Version: 1	Scale: 1:1
Date: 15.05.14	Drawing: NK/28

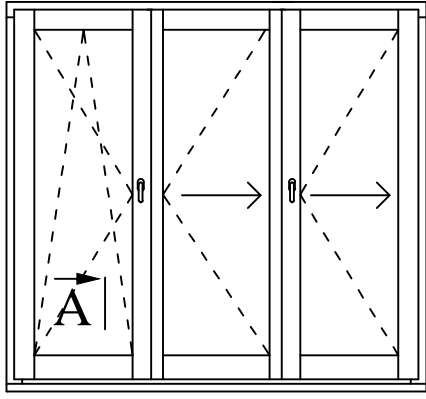

A

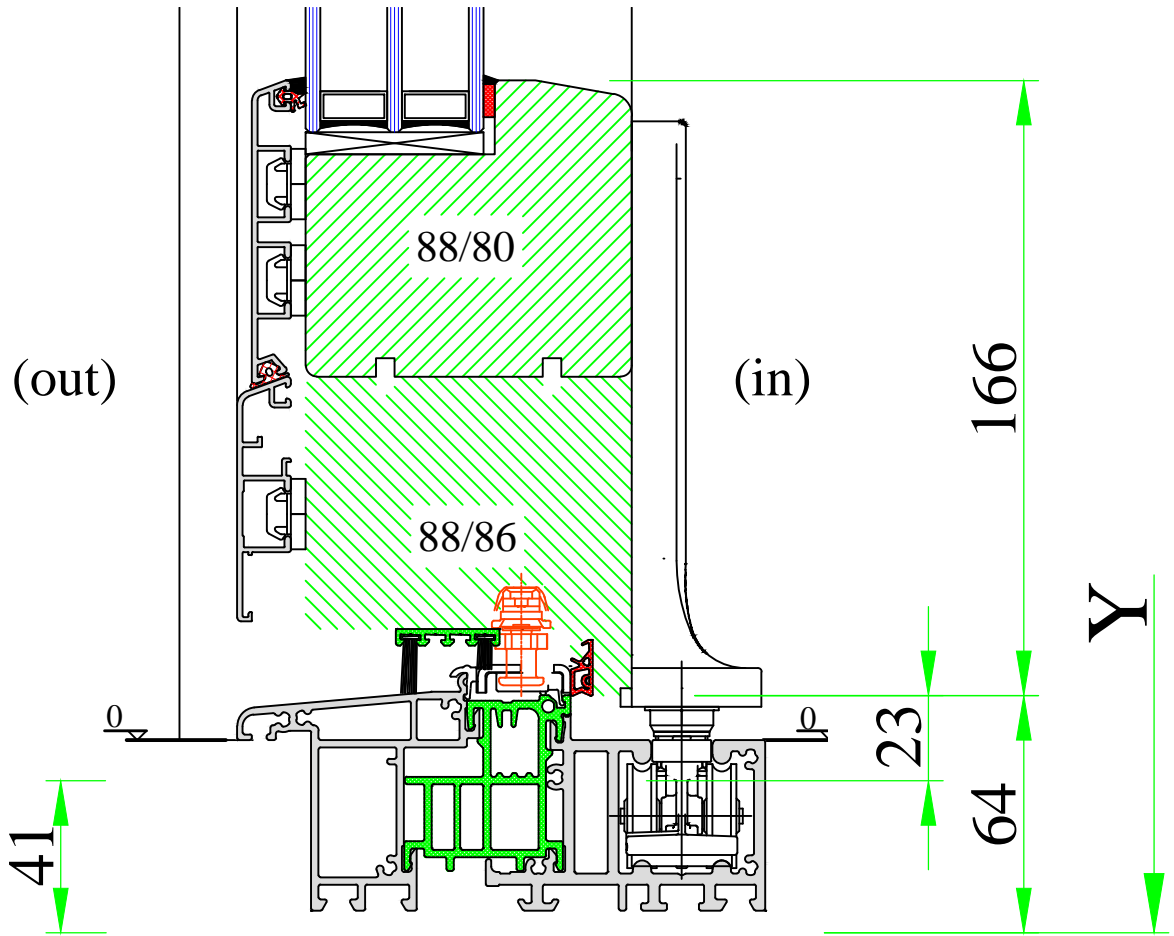

UNI WINDOWS Ltd.
 Unit 6, Edgefield Industrial Est.
 Loanhead, EH20 9TB
 Tel.: 0131 448 3931

THERMAX 1 / 2
 Folding sliding door with flat threshold Comfort

Version: 1	Scale: 1:2
Date: 15.05.14	Drawing: NK/29

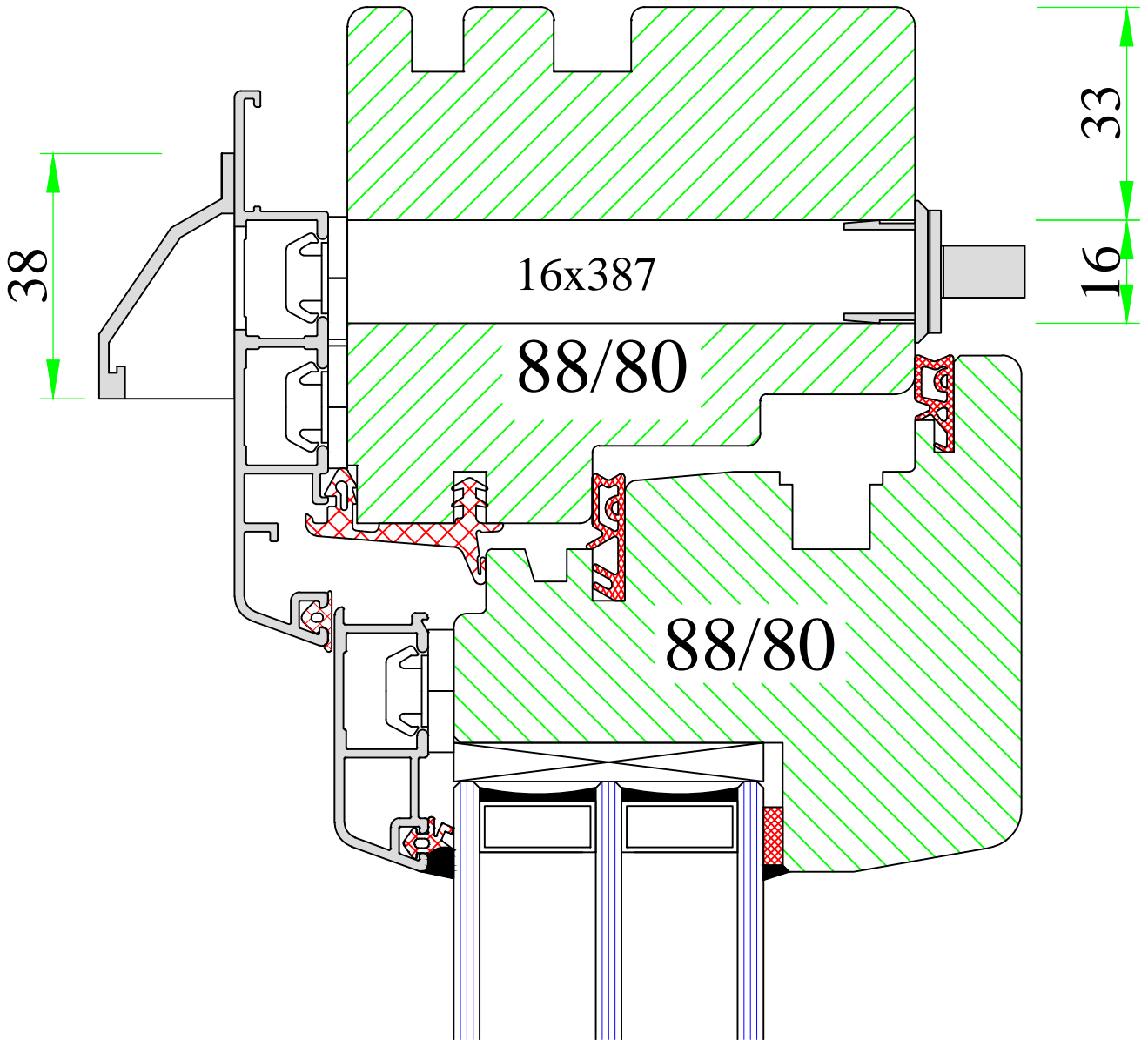
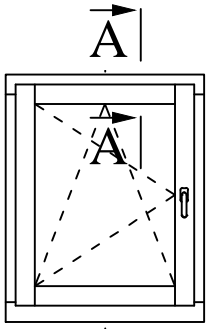

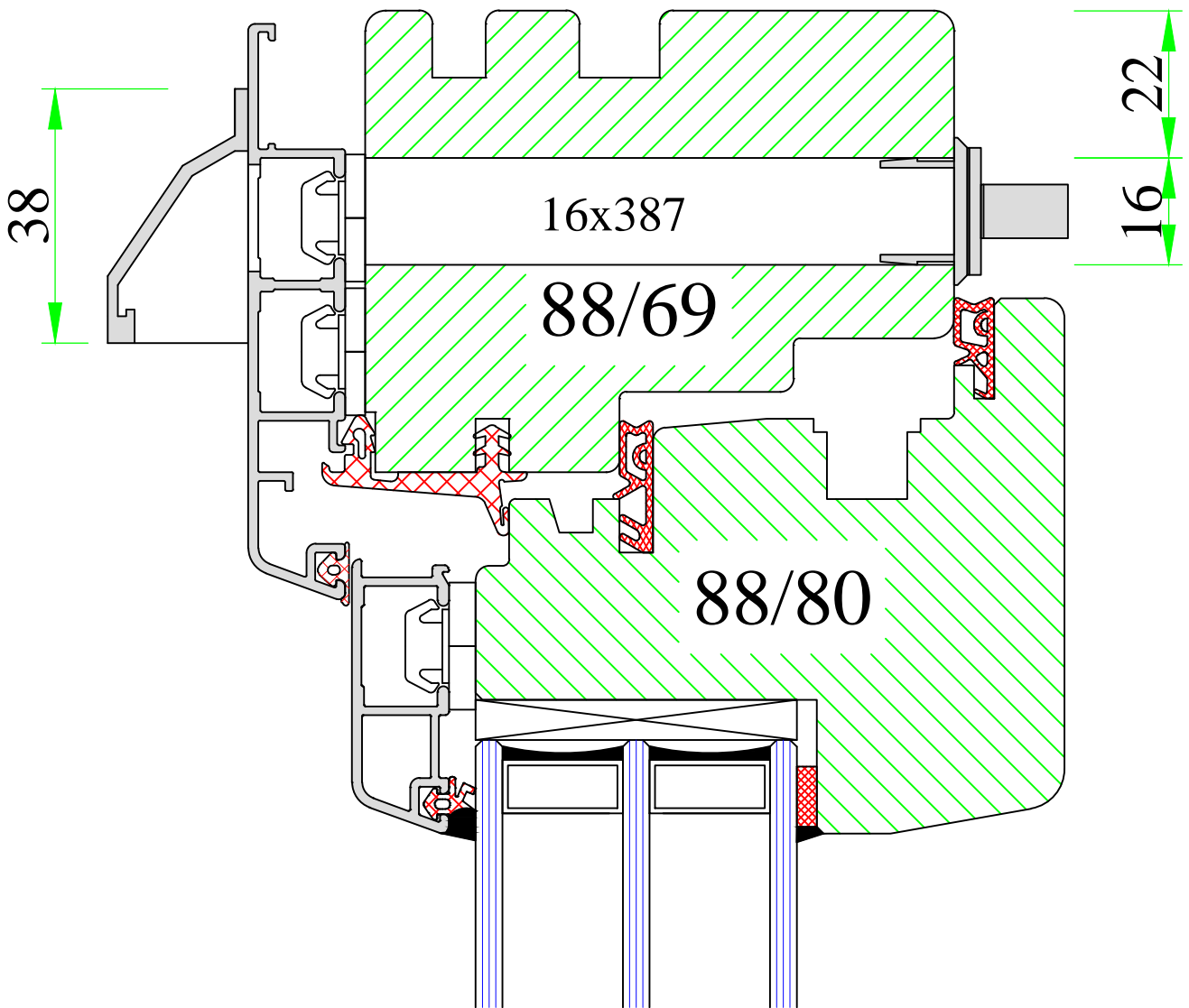
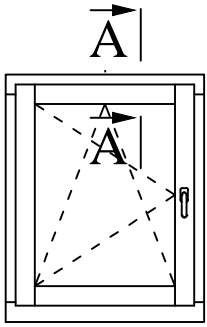

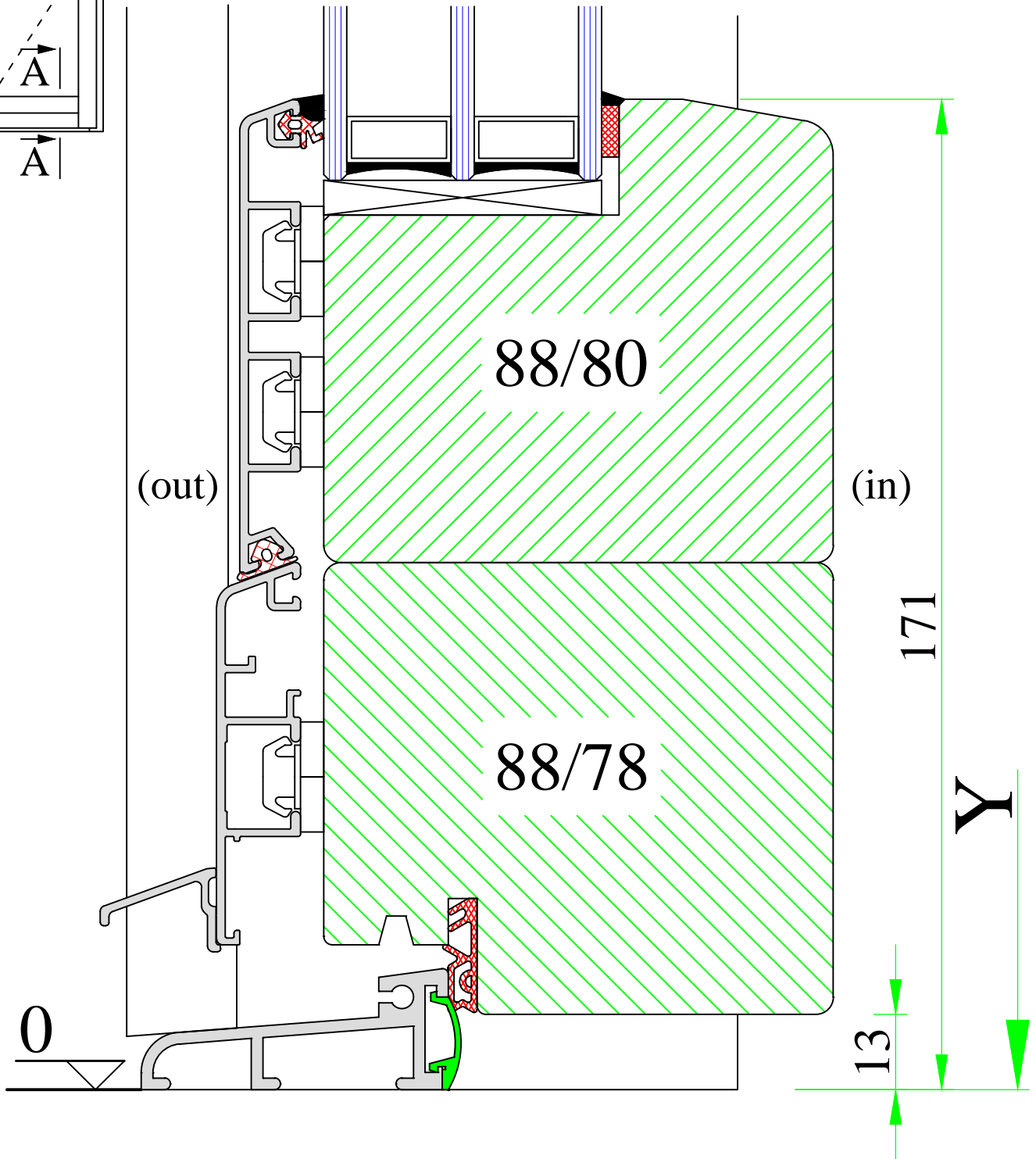
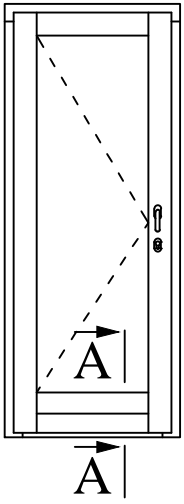

www.uniwin.co.uk



UNI WINDOWS Ltd.
 Unit 6, Edgefield Industrial Est.
 Loanhead, EH20 9TB
 Tel.: 0131 448 3931

THERMAX 1 / 2

Balcony door with Weser threshold (old)

Version:
1

Scale:
1:1

Date:
15.05.14

Drawing:
NK/31

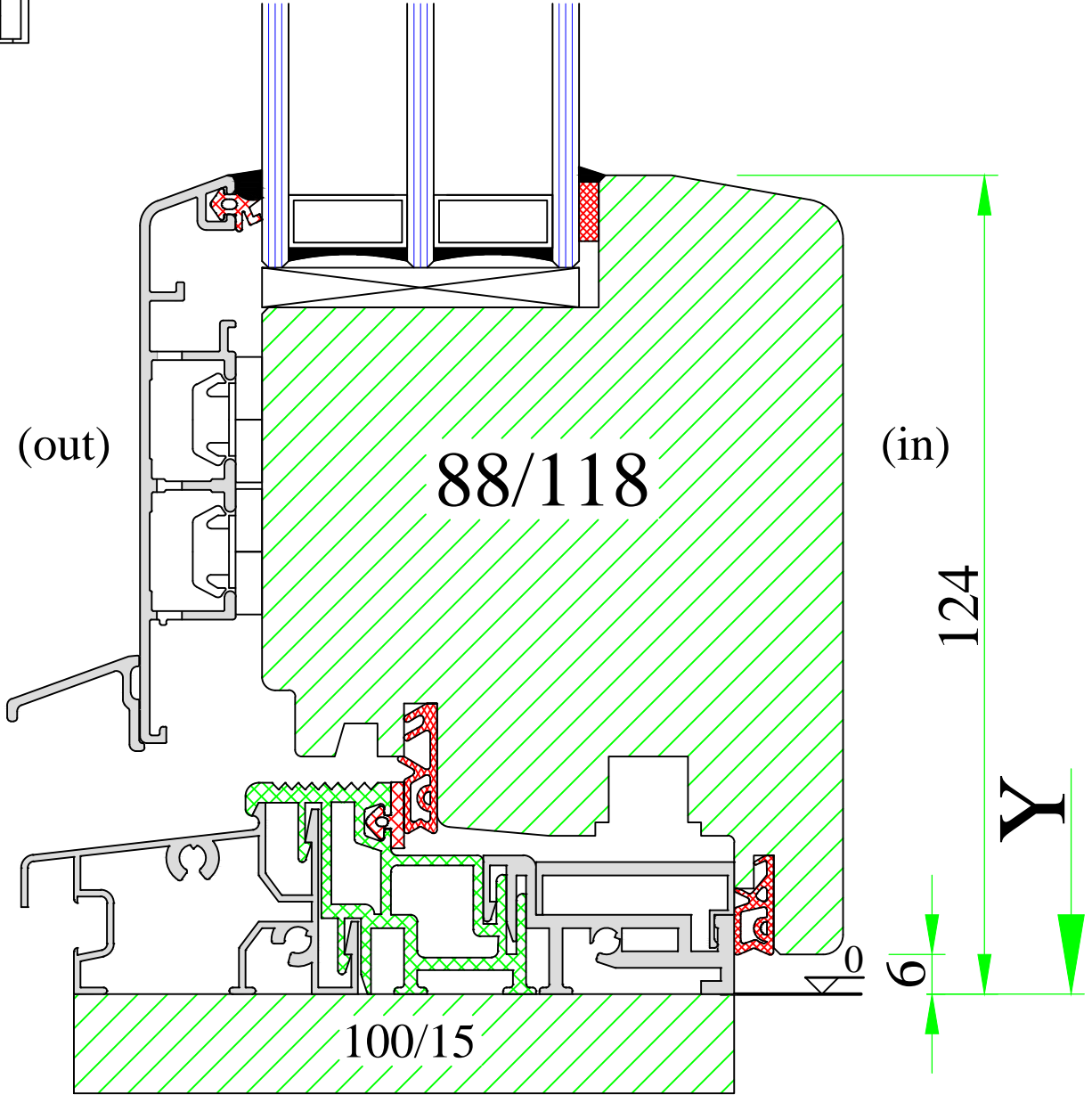
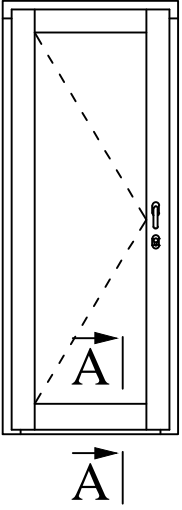

www.uniwin.co.uk



UNI WINDOWS Ltd.
 Unit 6, Edgefield Industrial Est.
 Loanhead, EH20 9TB
 Tel.: 0131 448 3931

THERMAX 1 / 2

Balcony door with Weser threshold

Version:
1

Scale:
1:1

Date:
15.05.14

Drawing:
NK/33

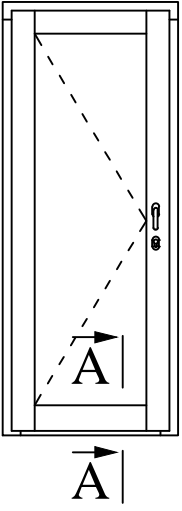

A

